

2

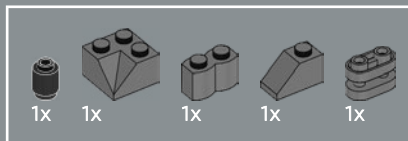

3

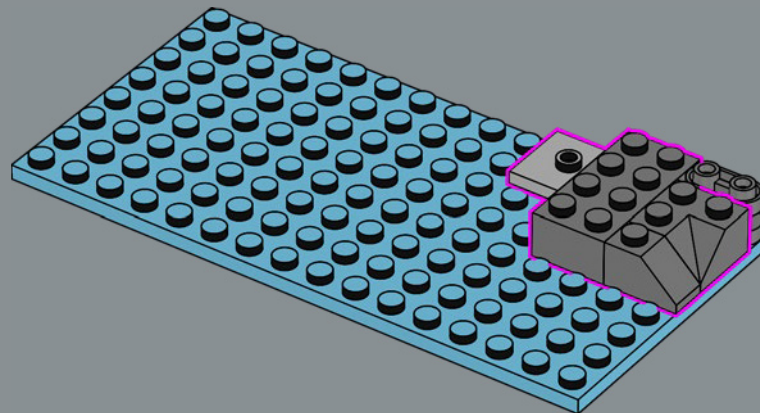

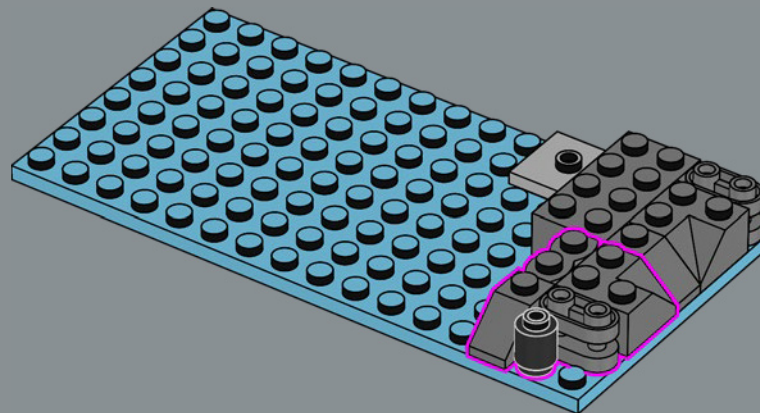

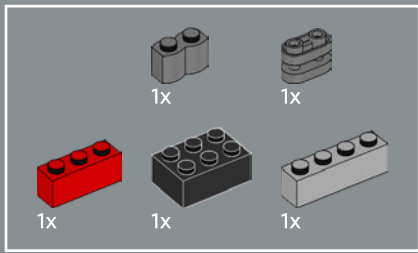

4

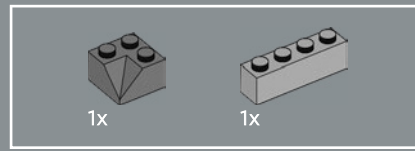
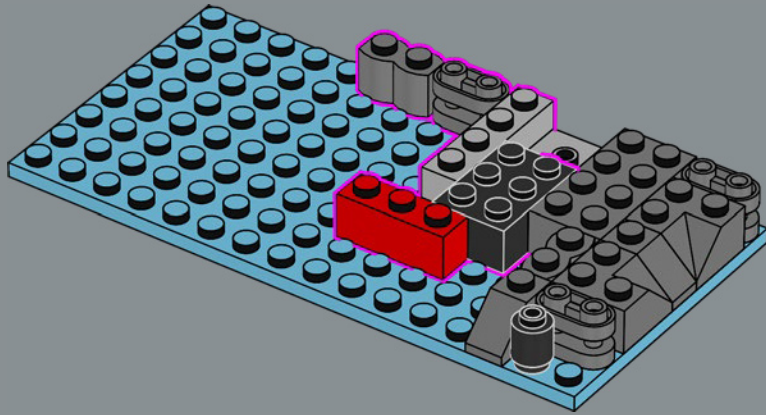

5

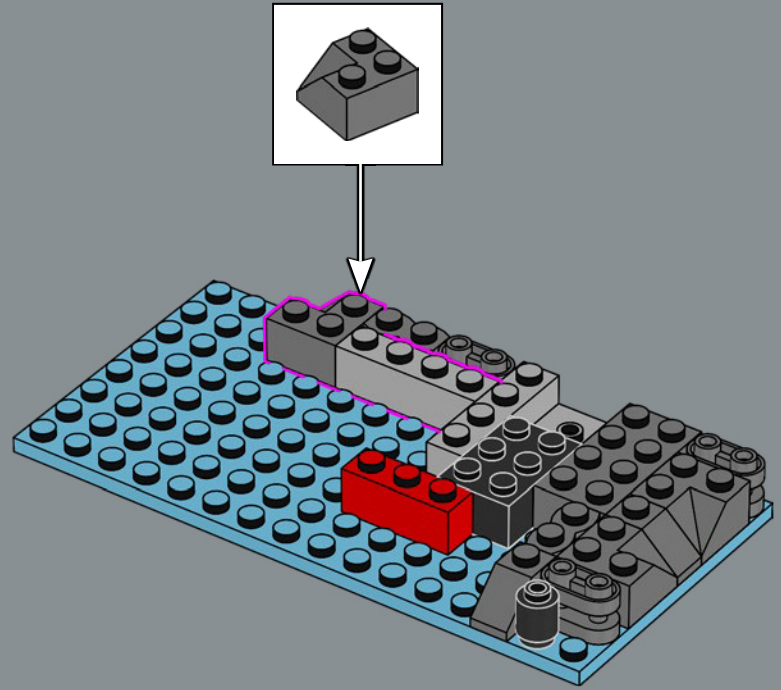

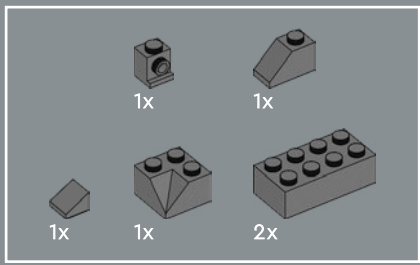

6

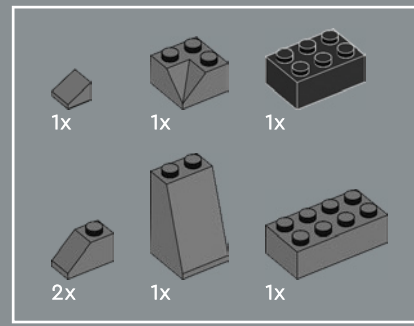
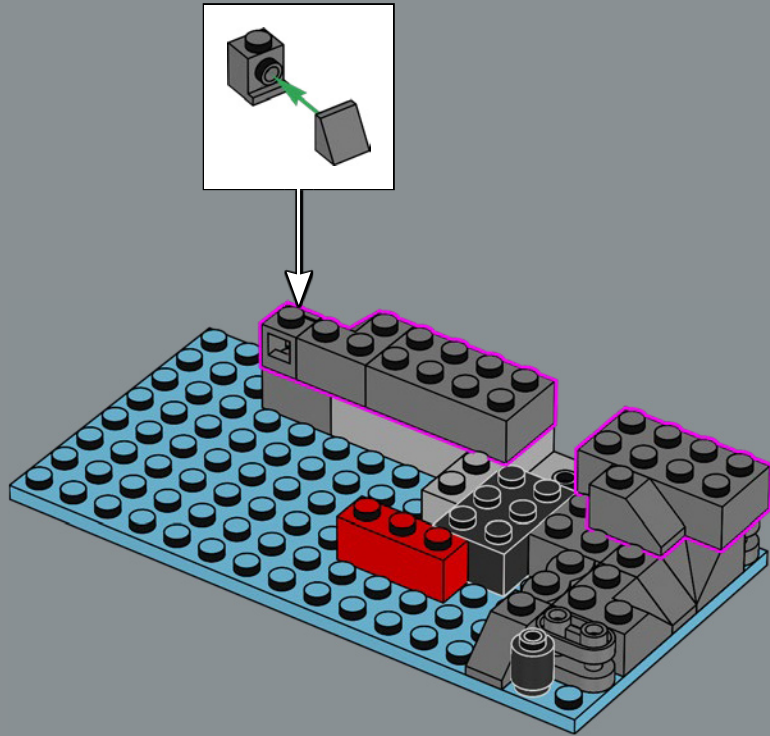

7

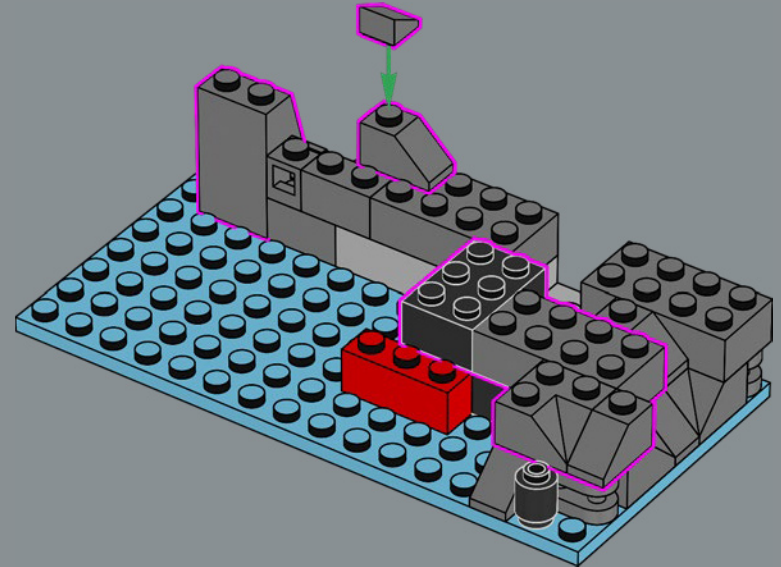



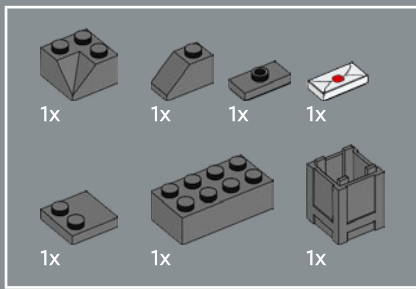

8

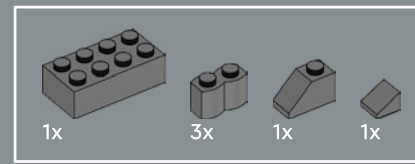
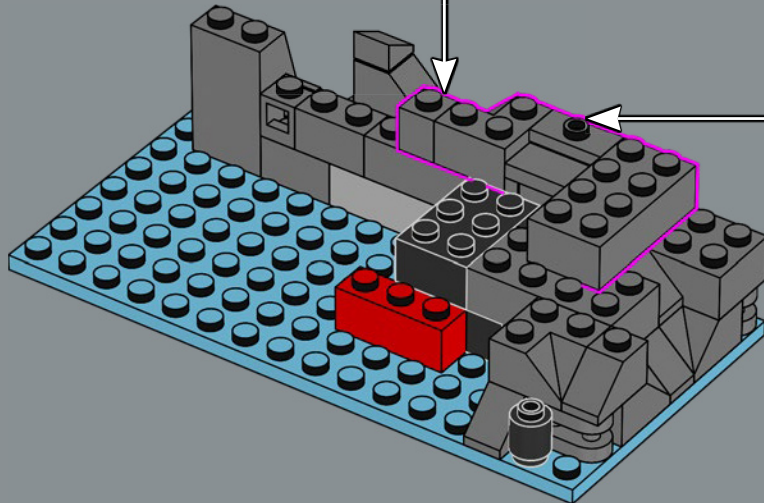
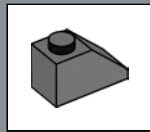
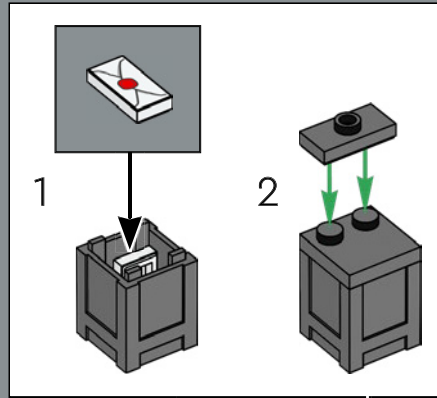

9

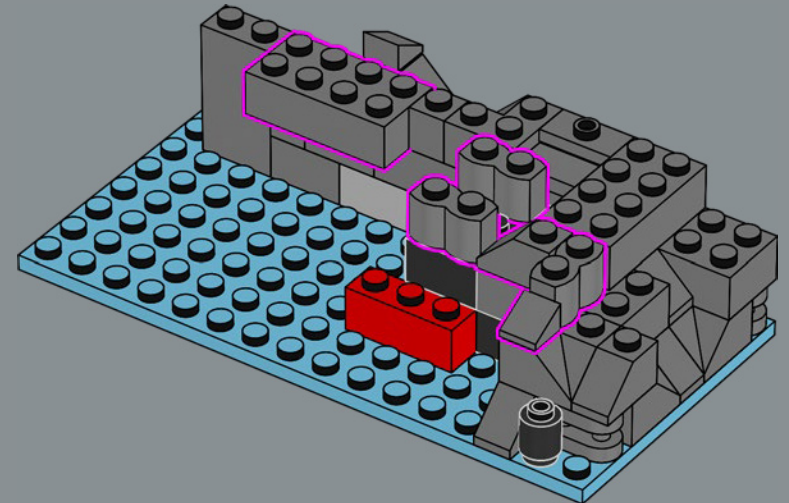

Ein versteckter Brief? Von wem könnte der wohl stammen? Wer kann dieses Geheimnis lüften?

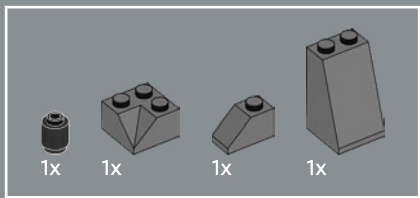

10

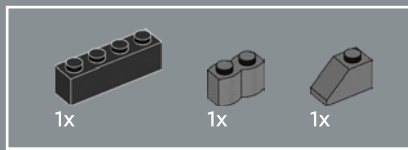
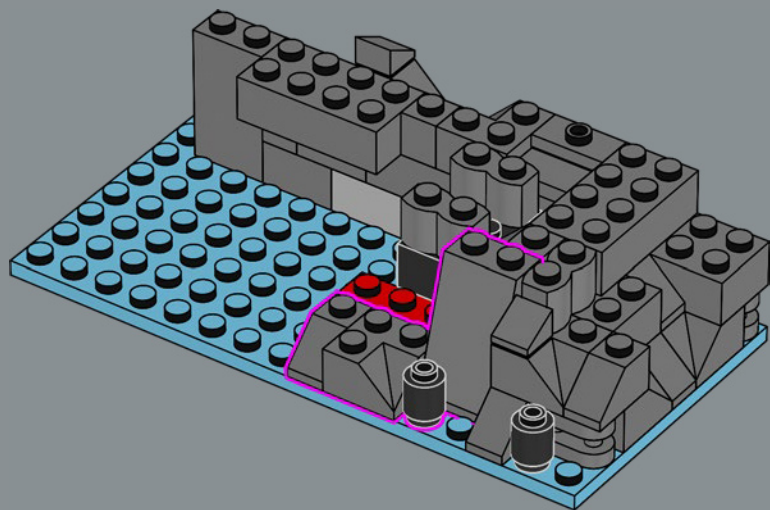

11

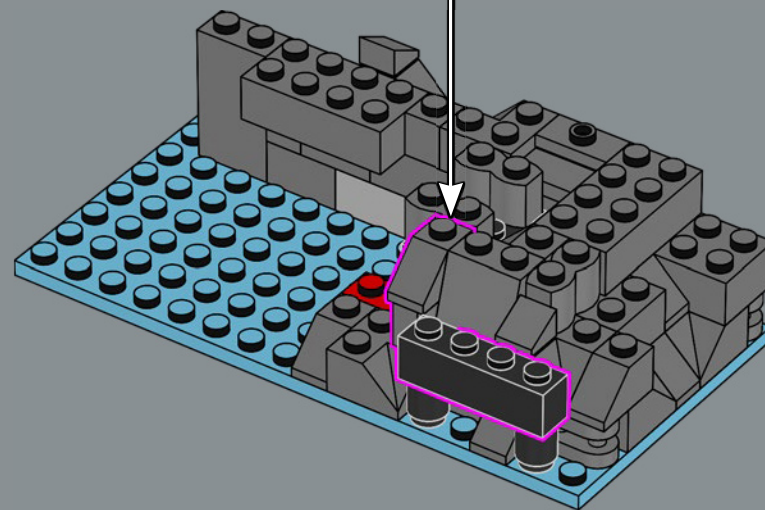
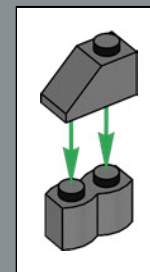



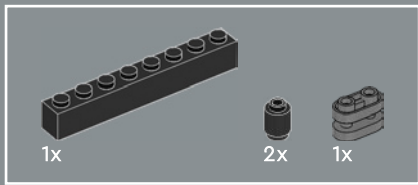

12

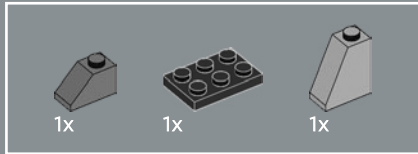
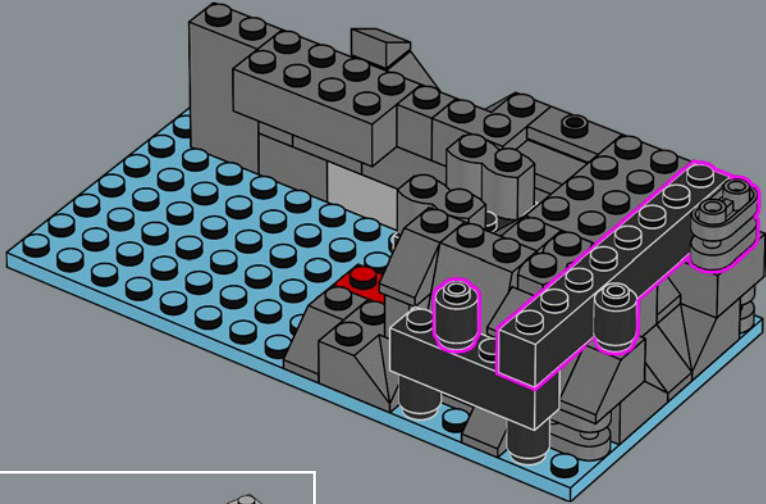

13

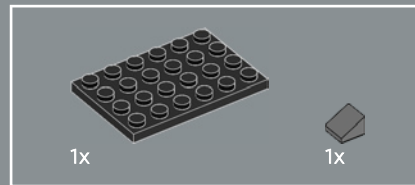
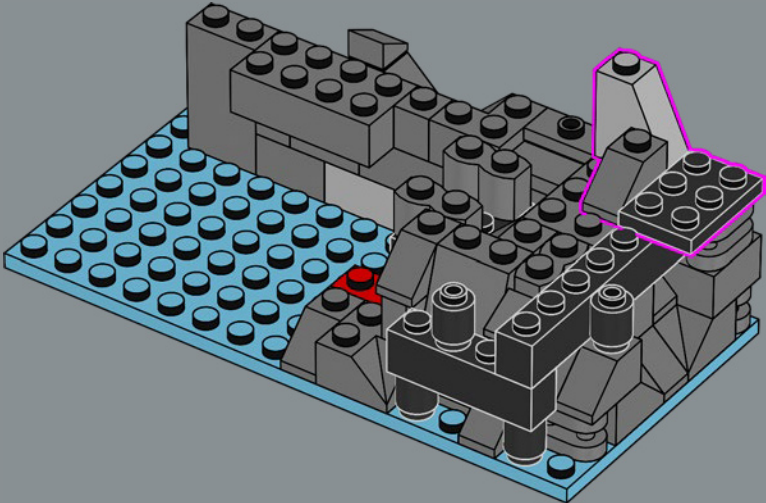

14

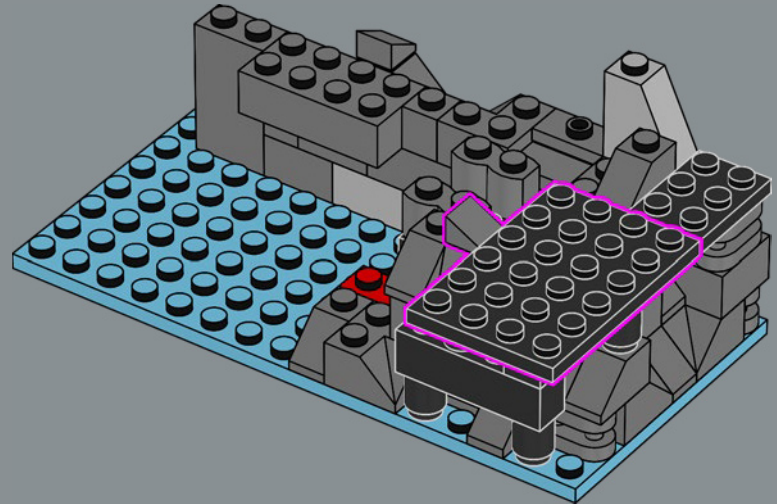

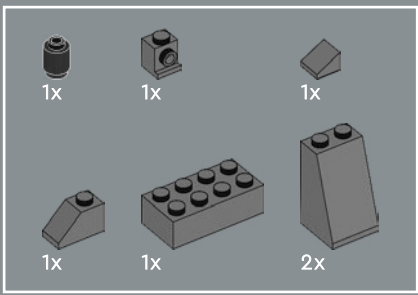

15

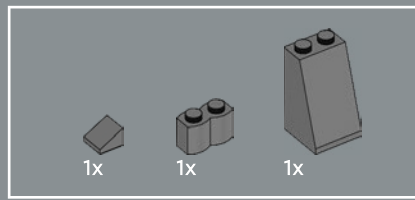
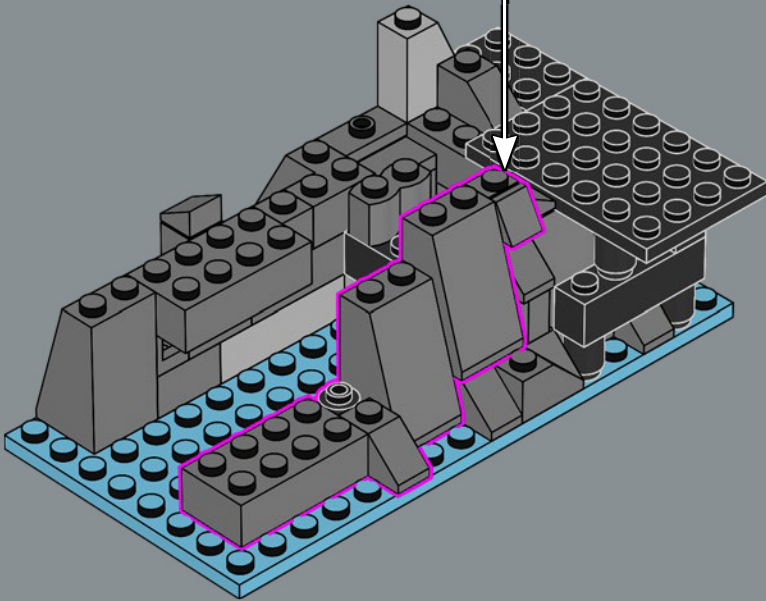
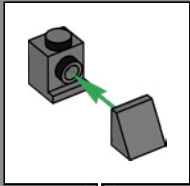

16

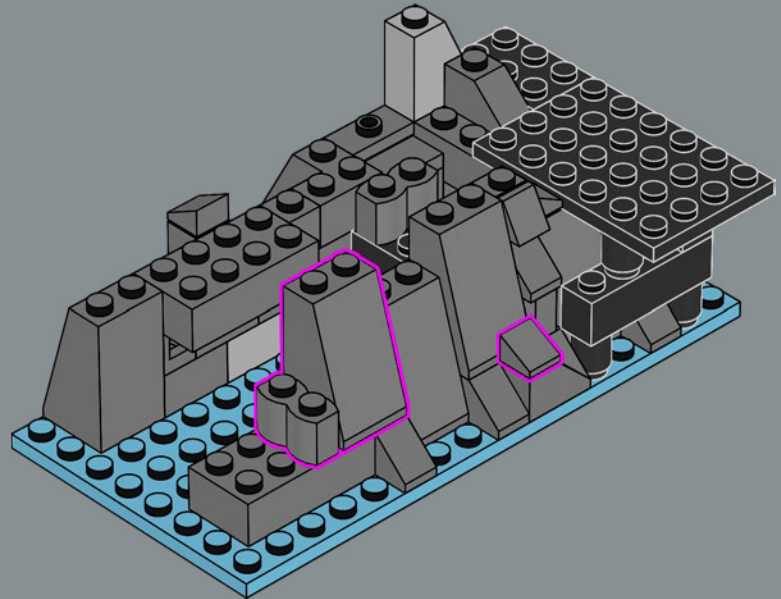



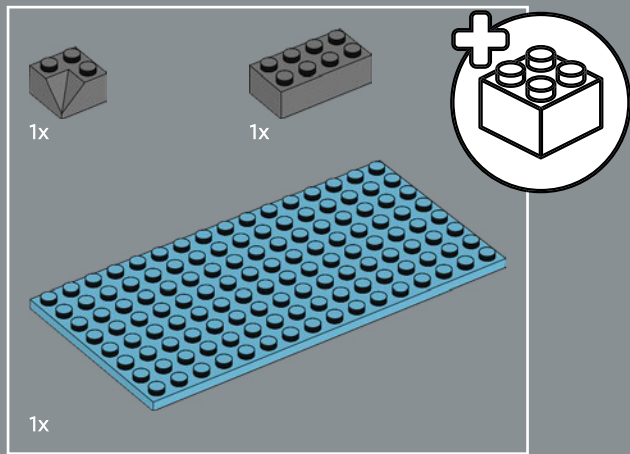

17

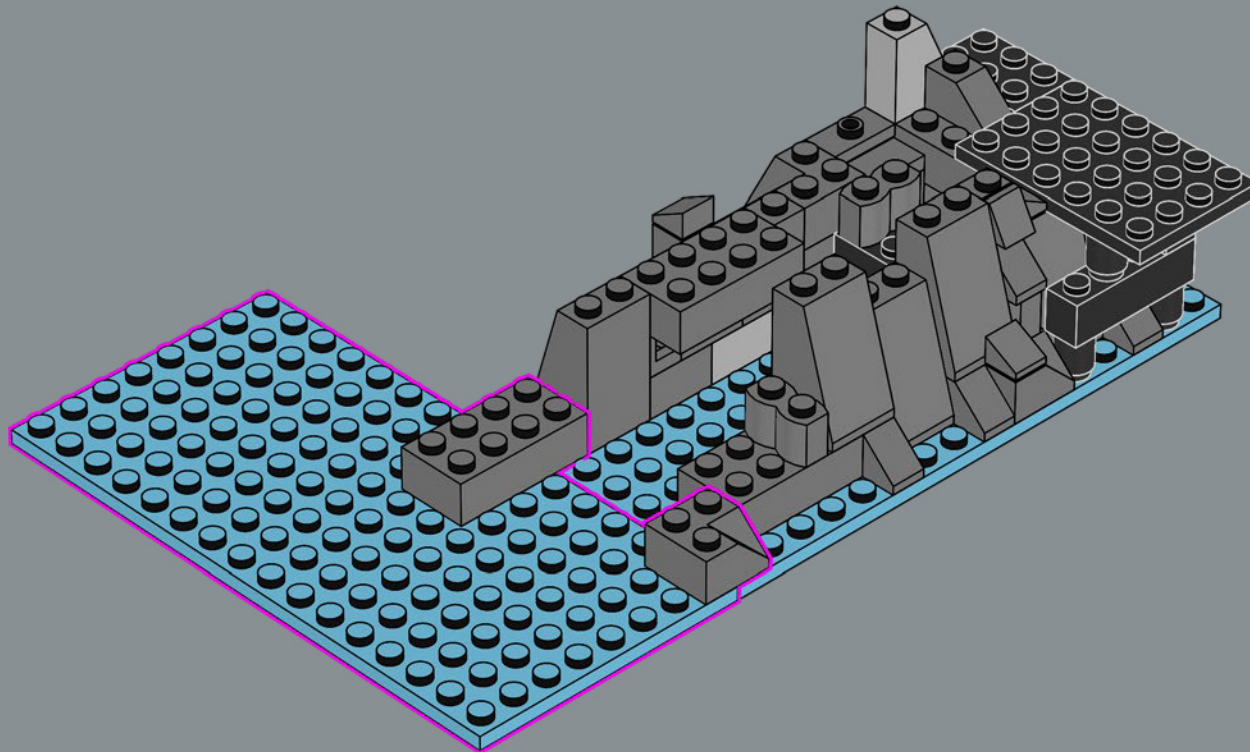

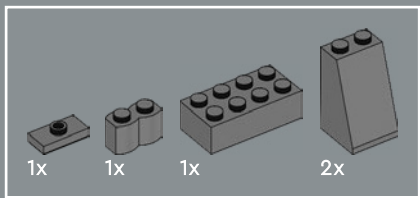

18

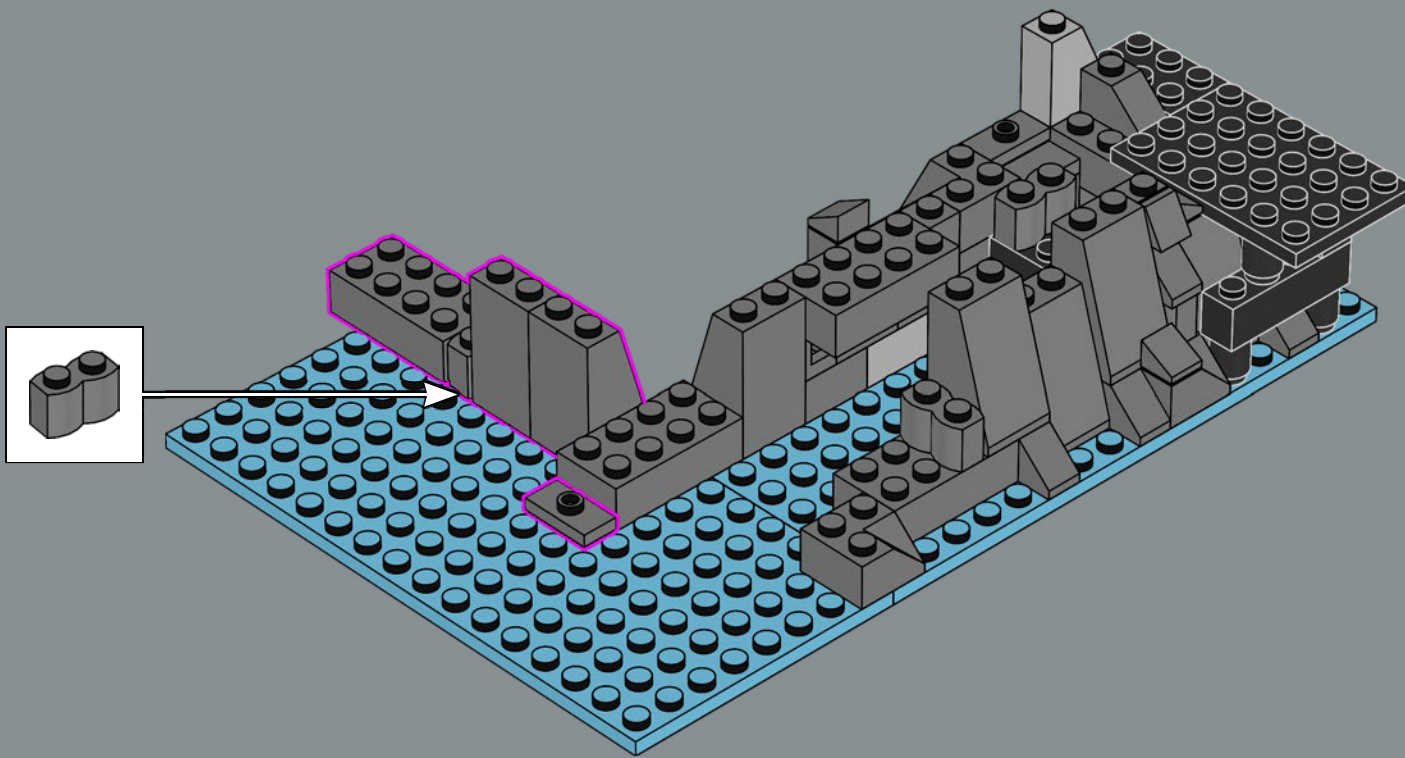

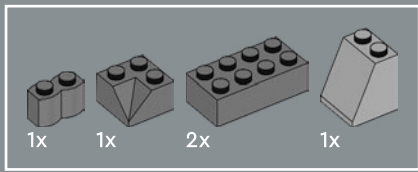

19

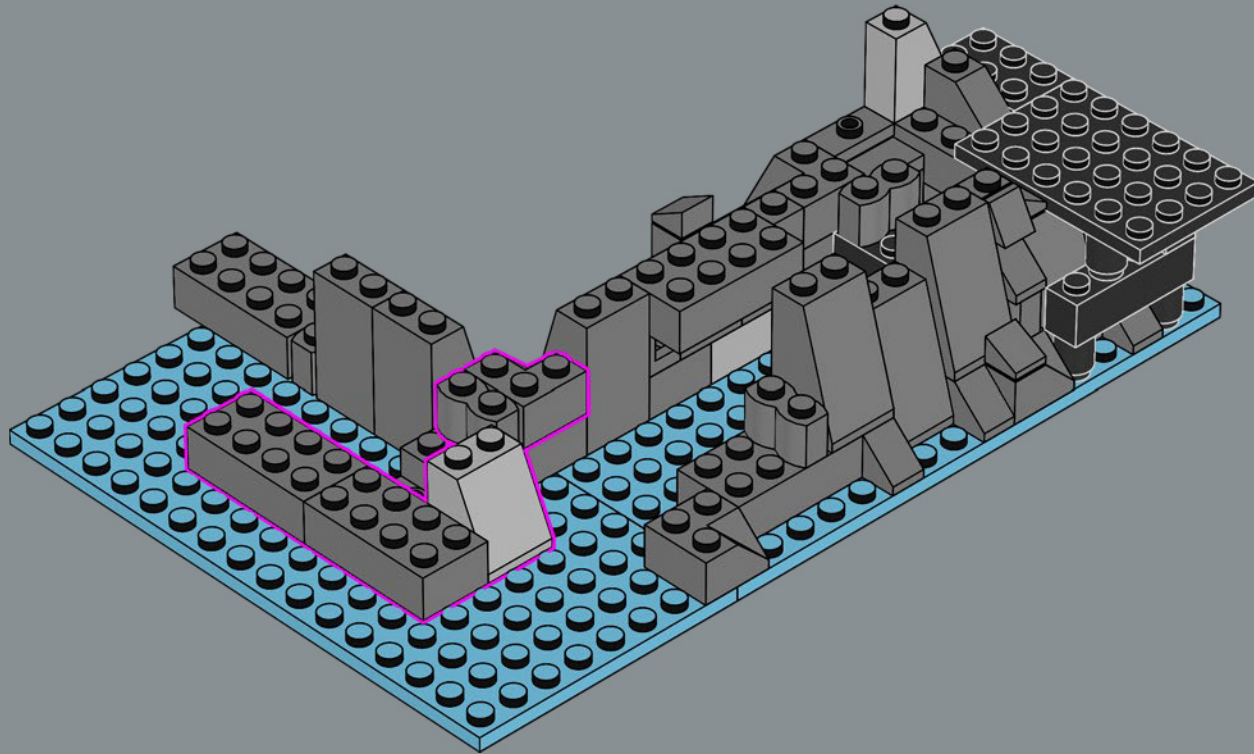



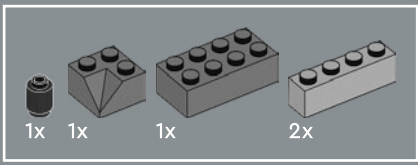

20

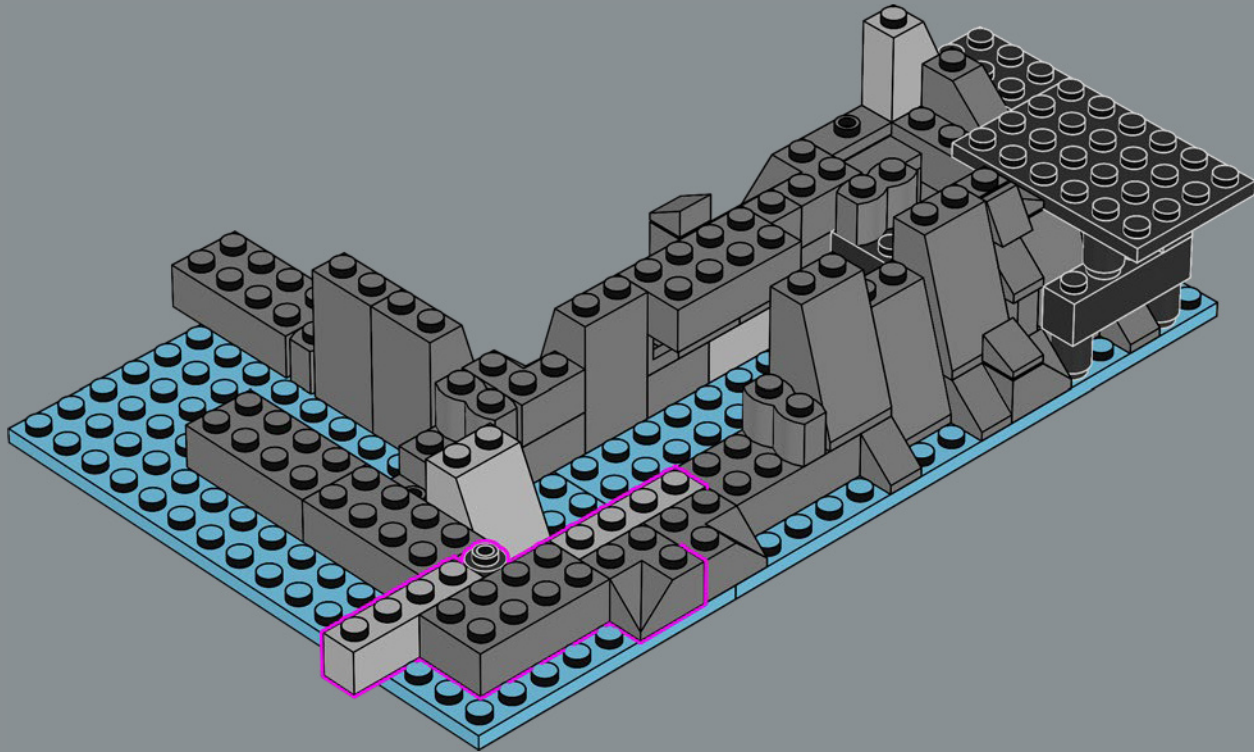

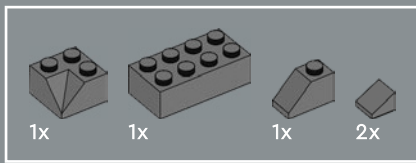

21

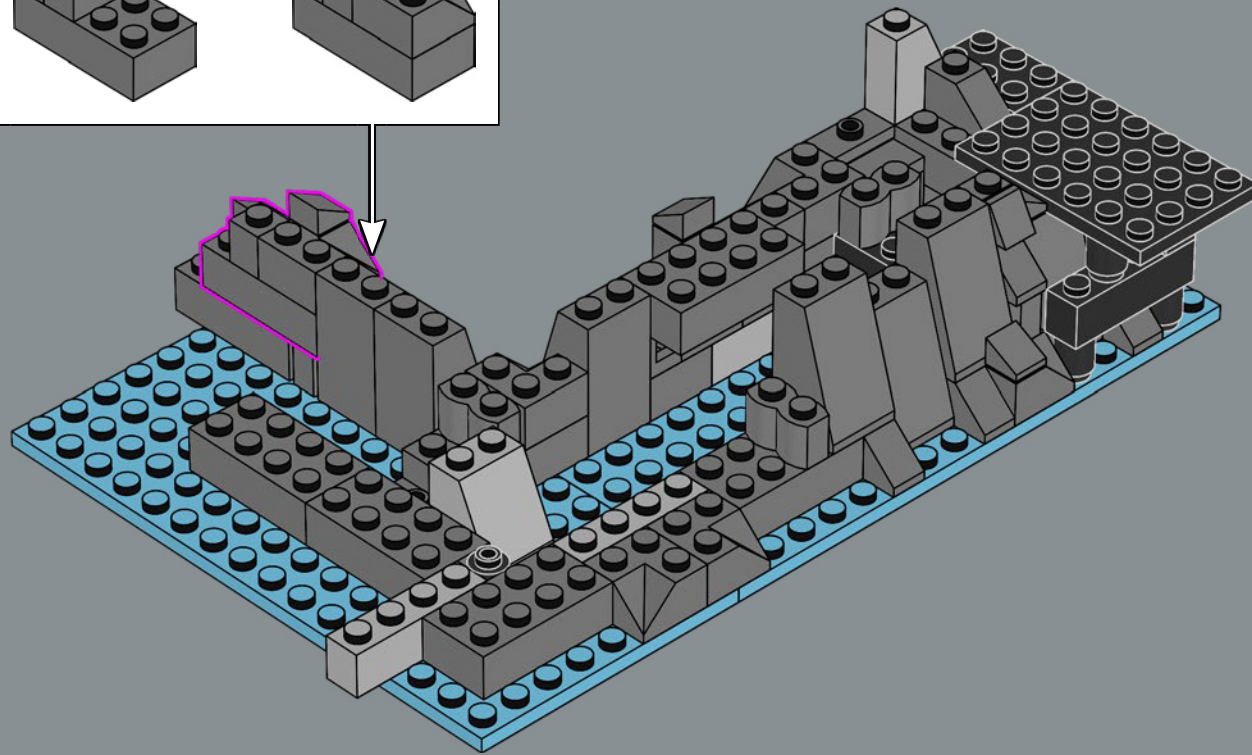
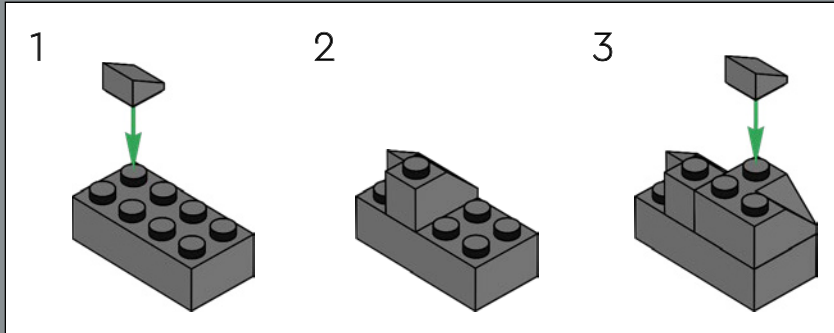

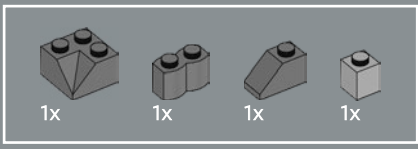

22

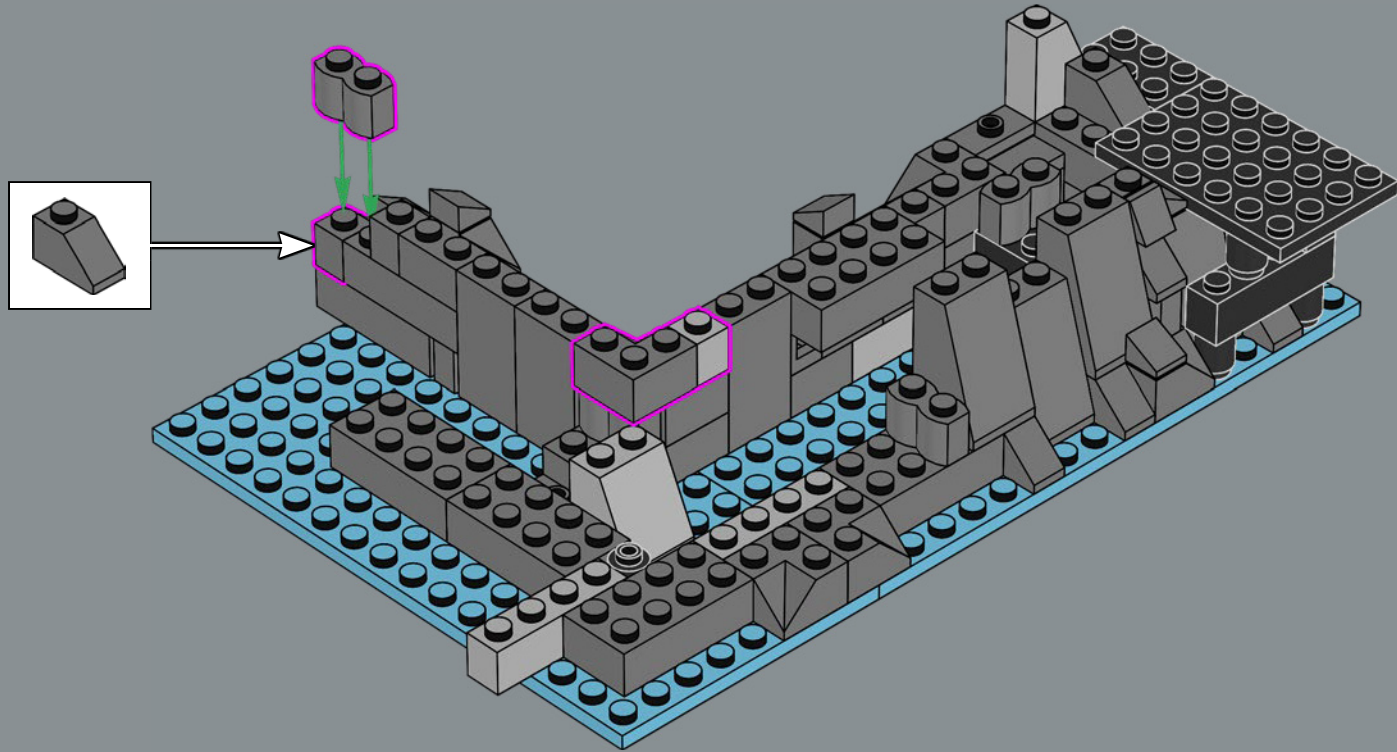



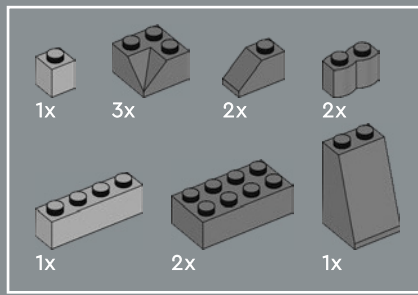

23

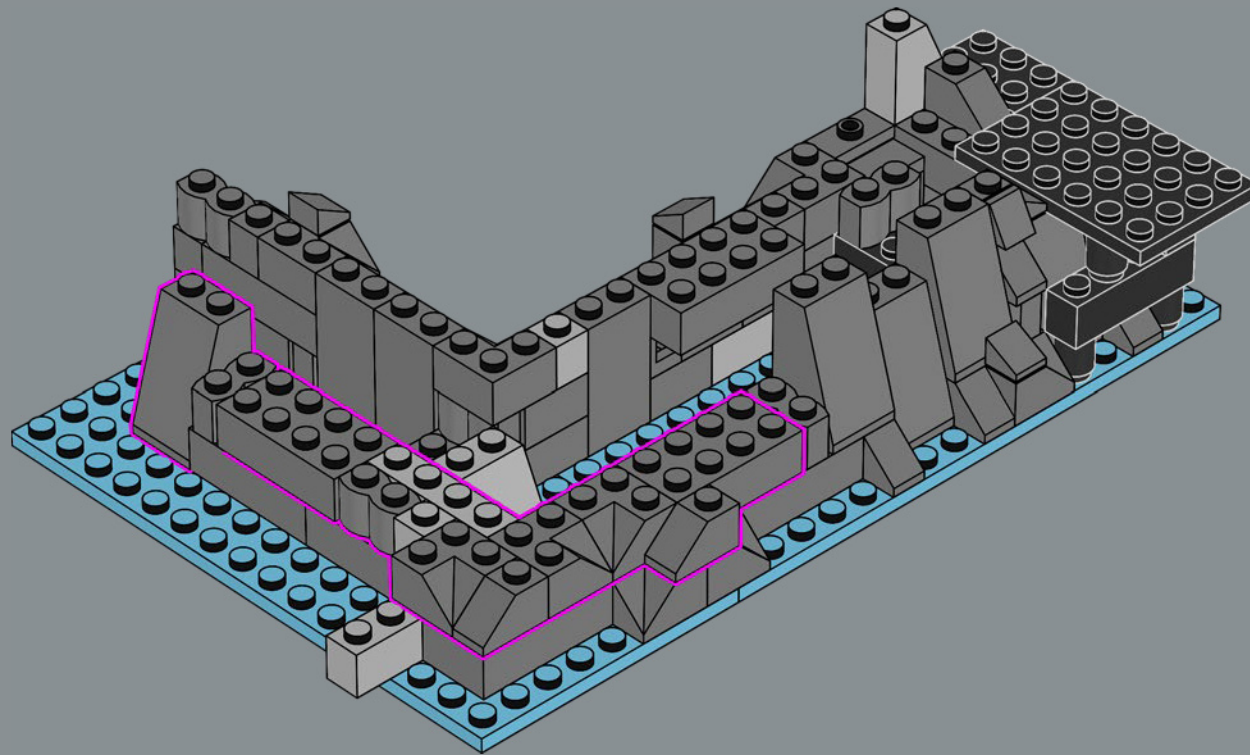

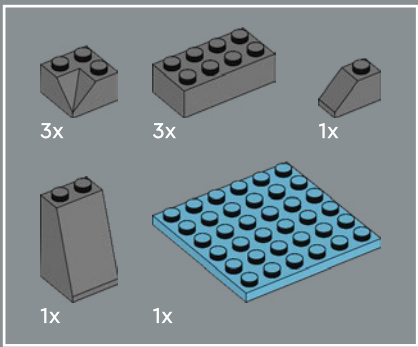

24

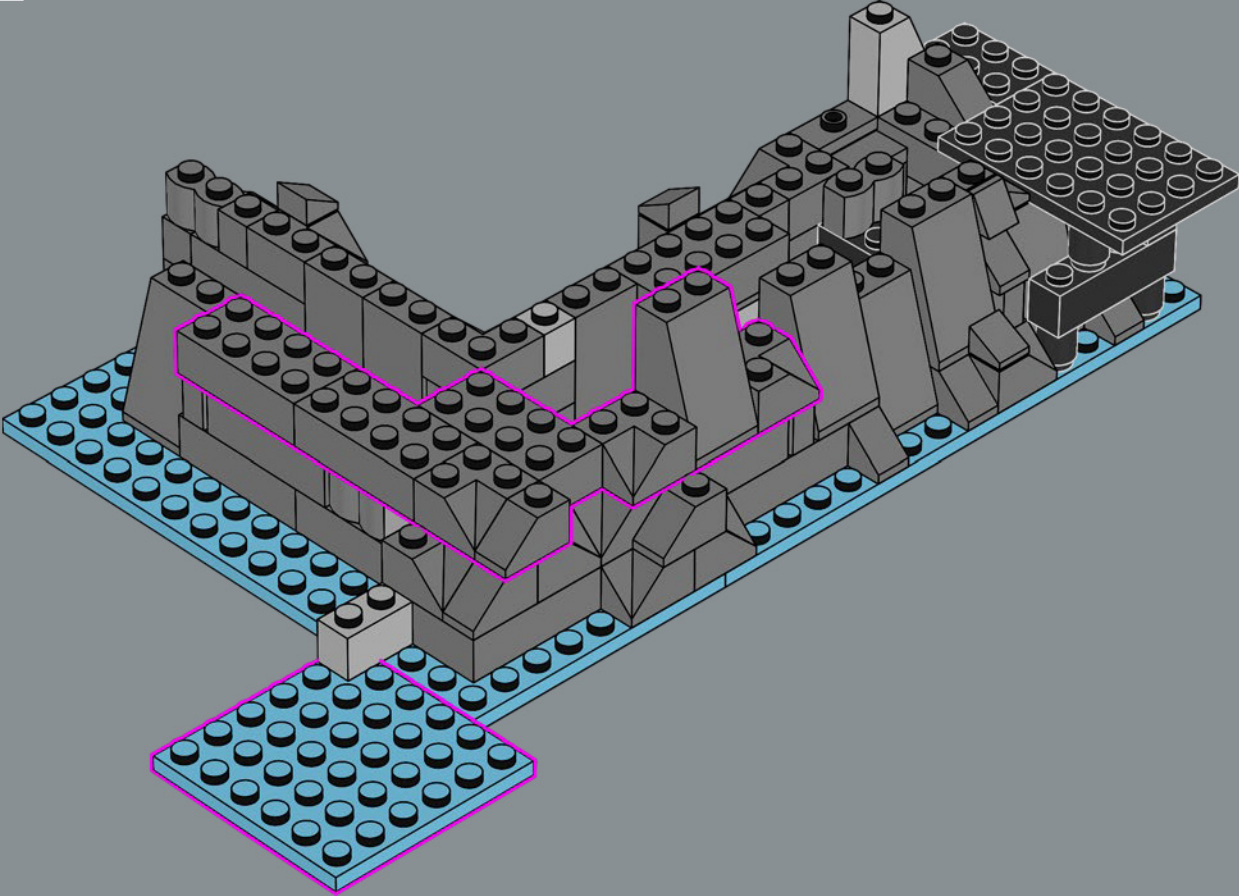

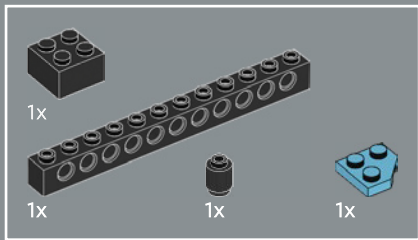

25

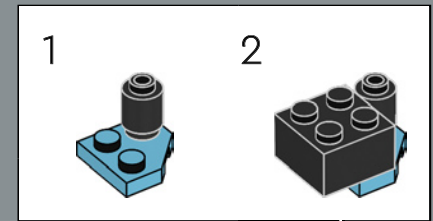
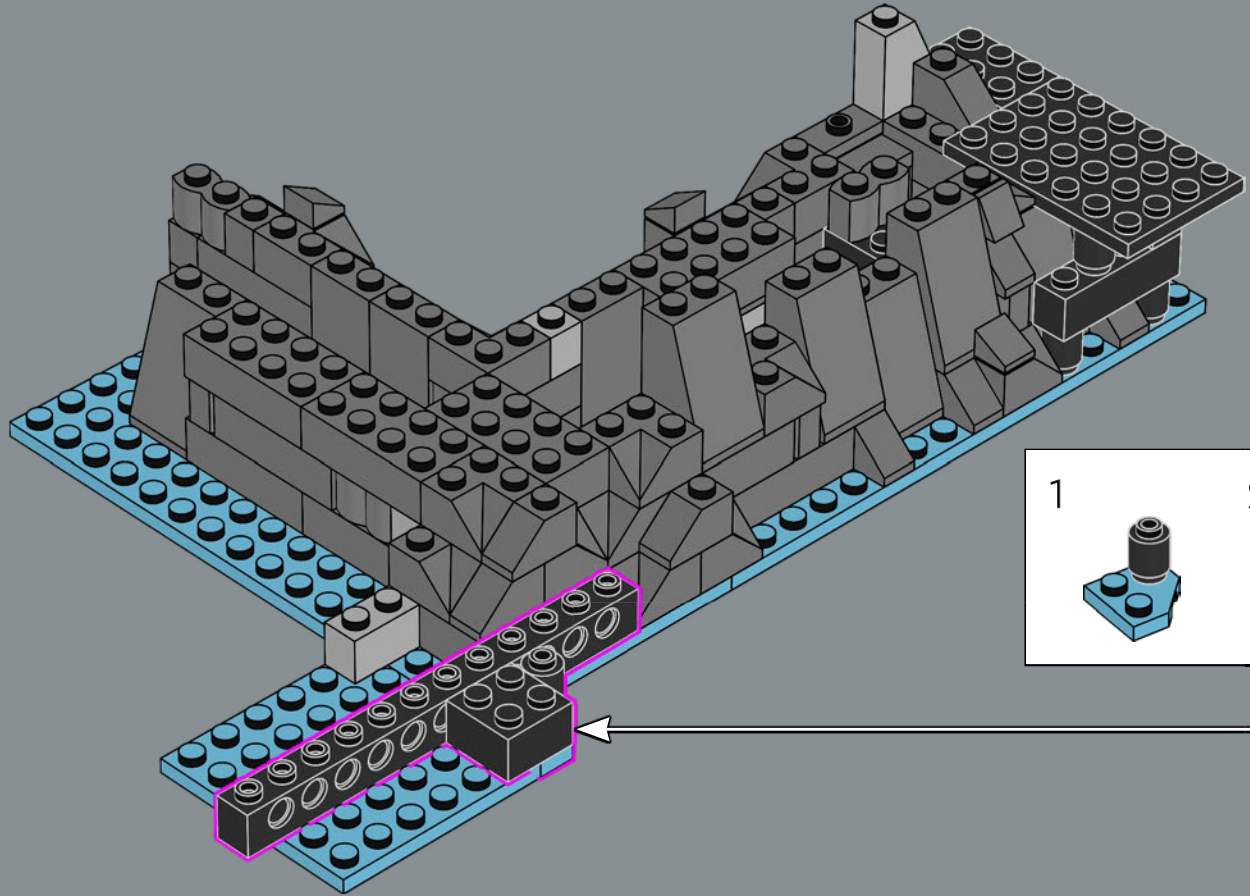



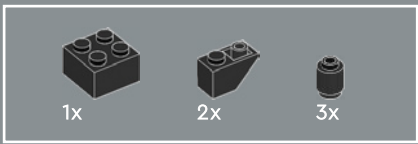

26

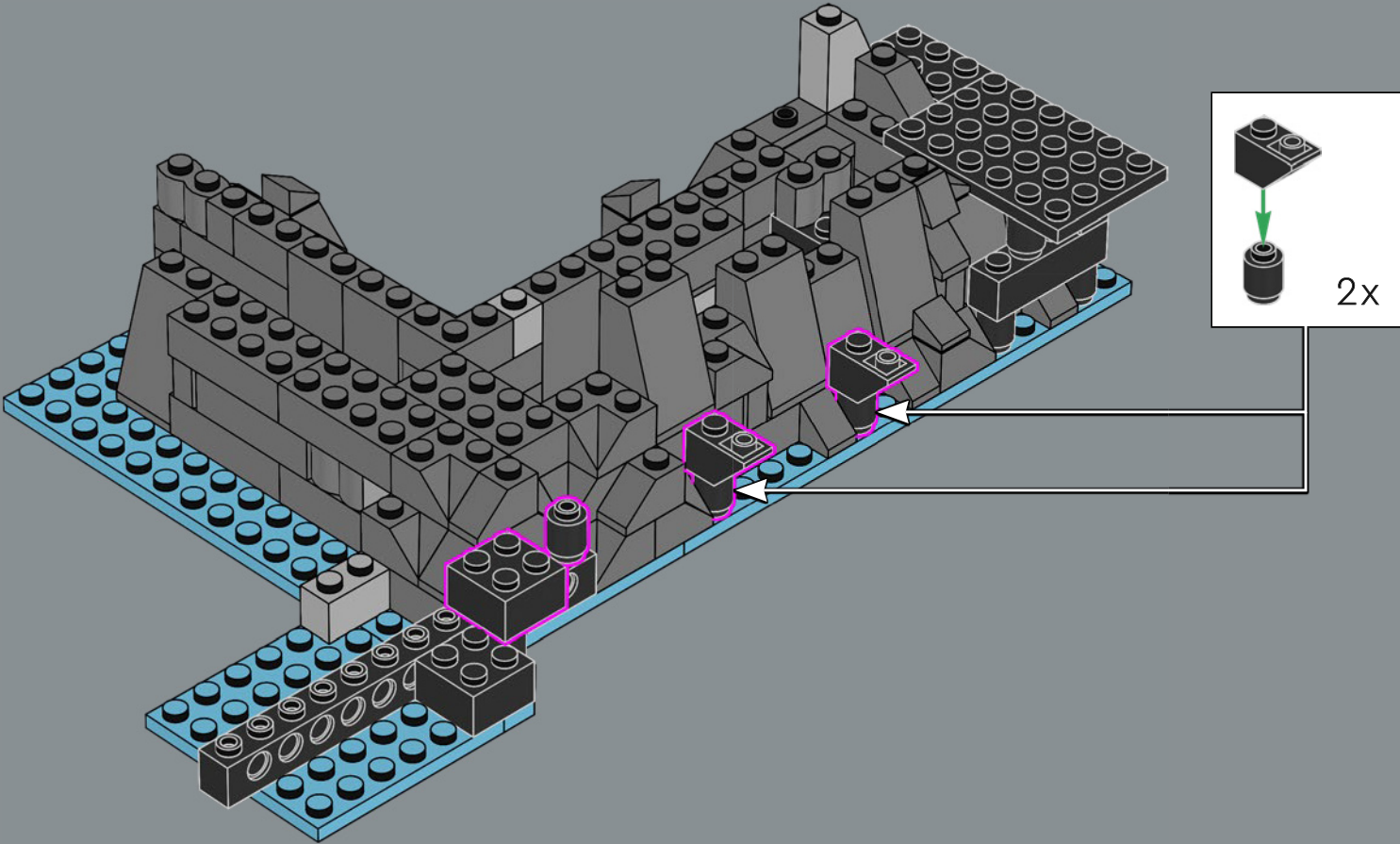

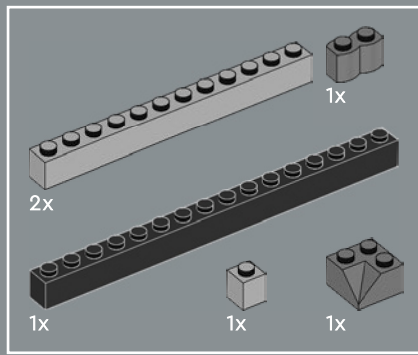

27

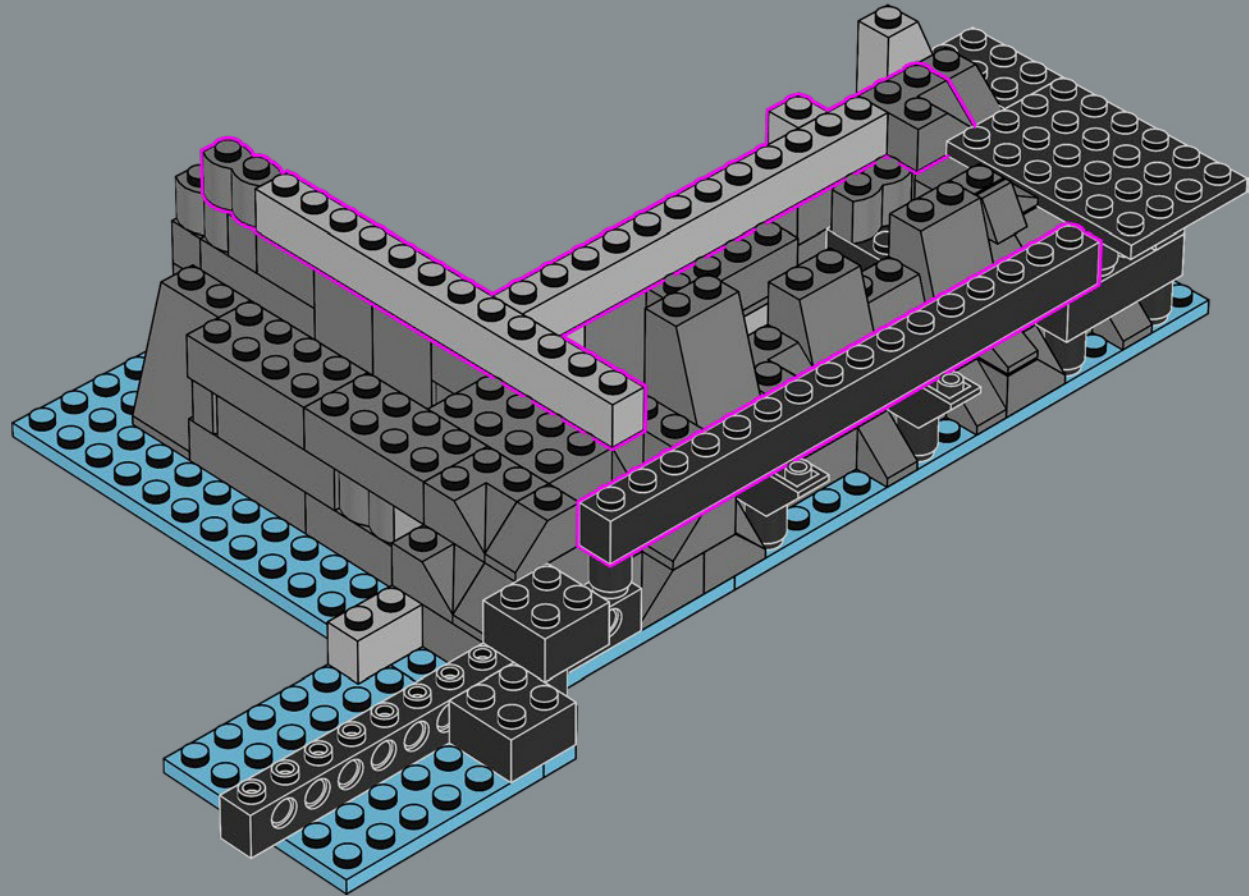

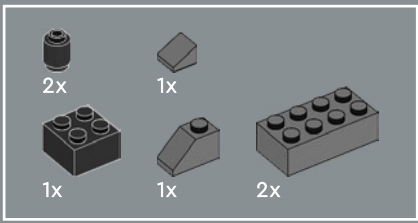

28

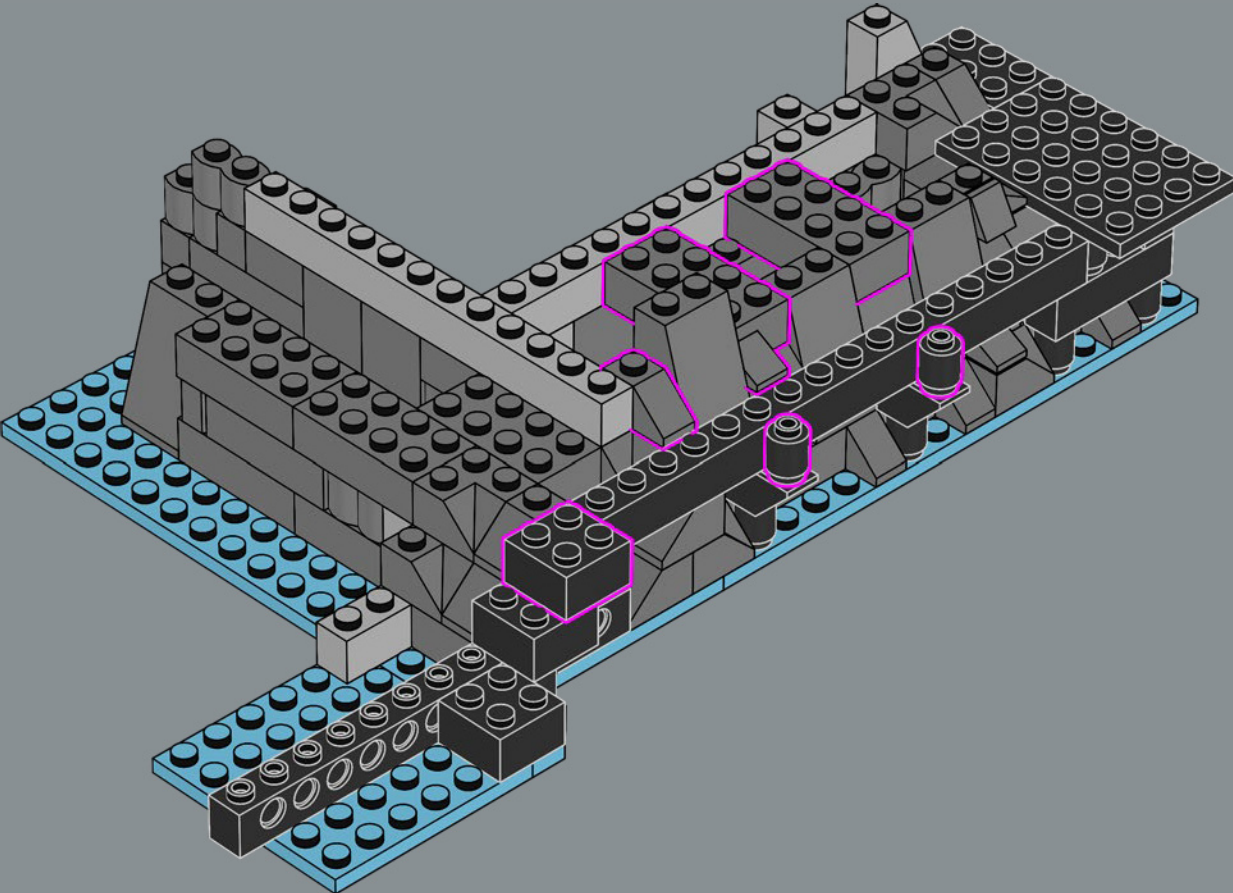



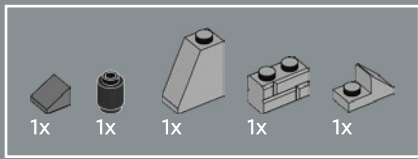

29

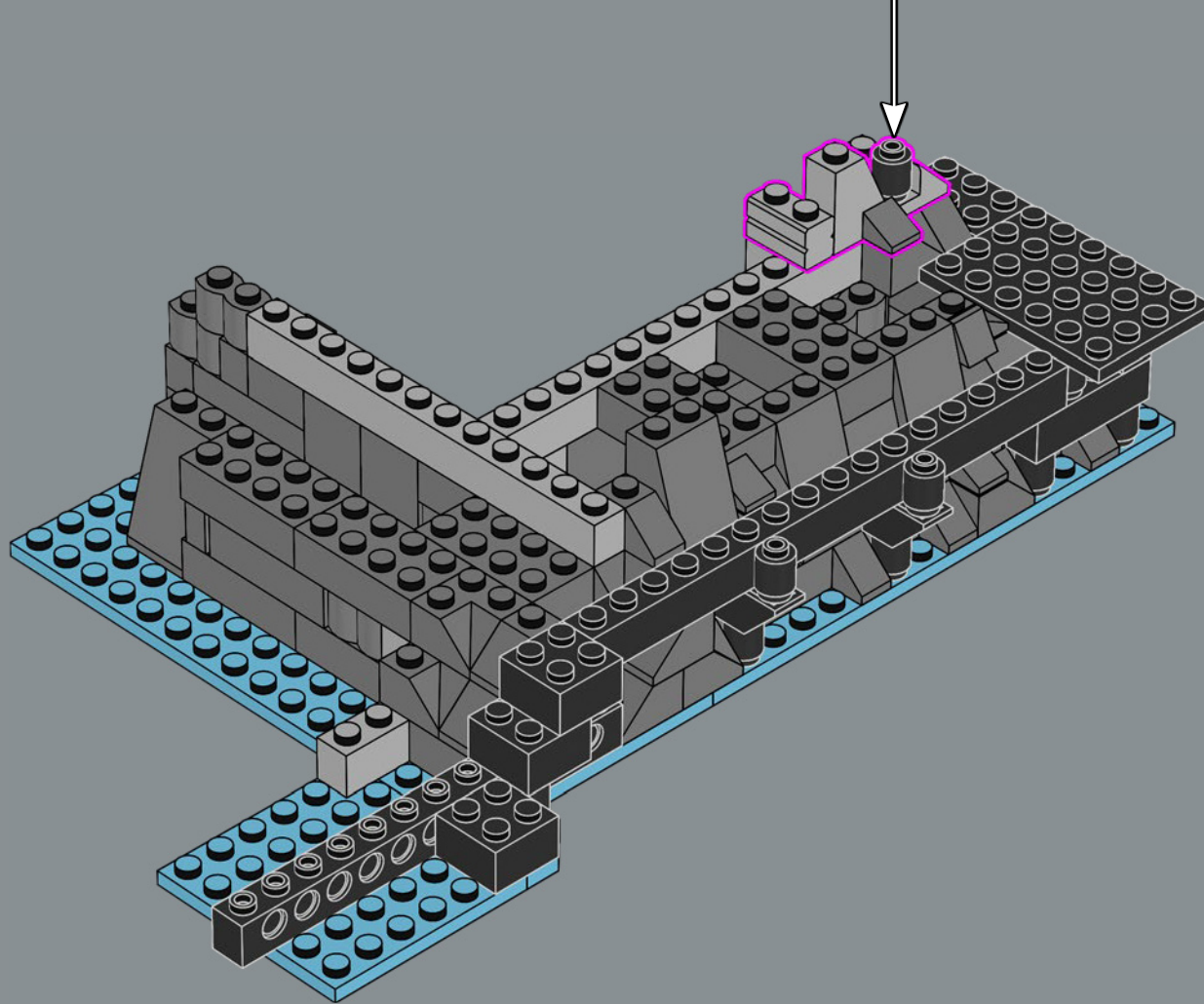
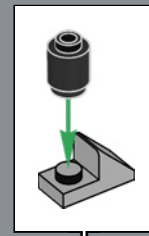

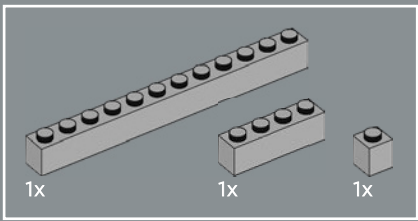

30

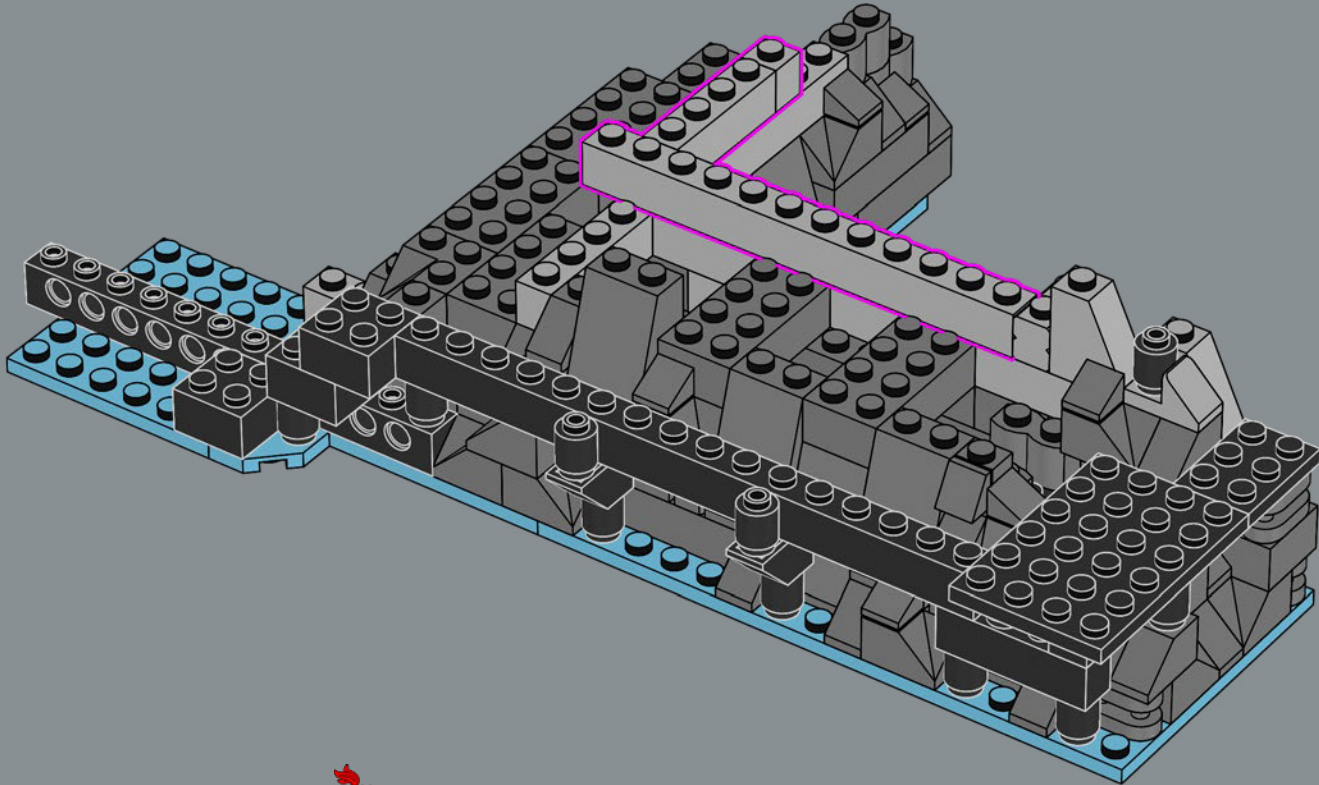

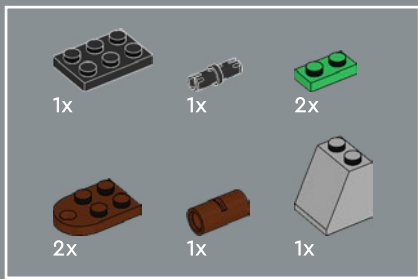

31

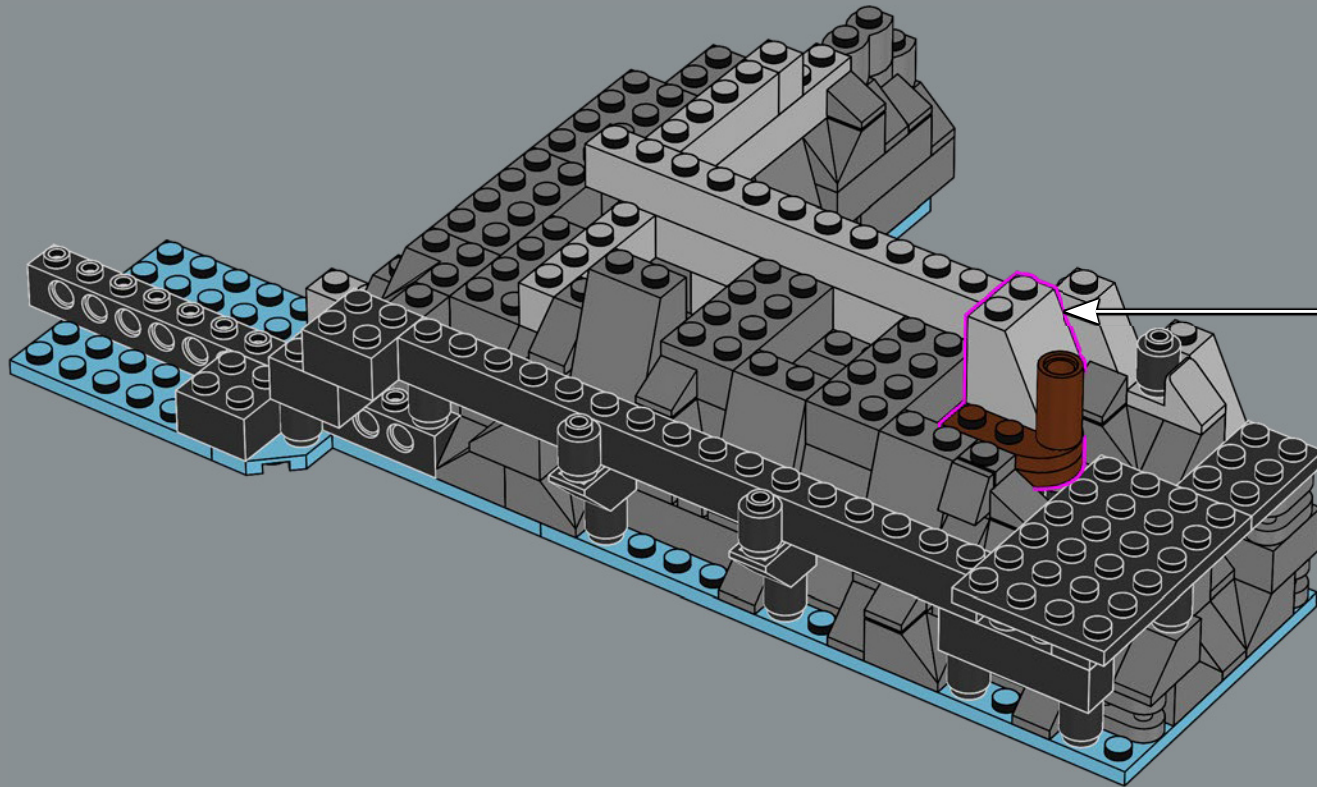
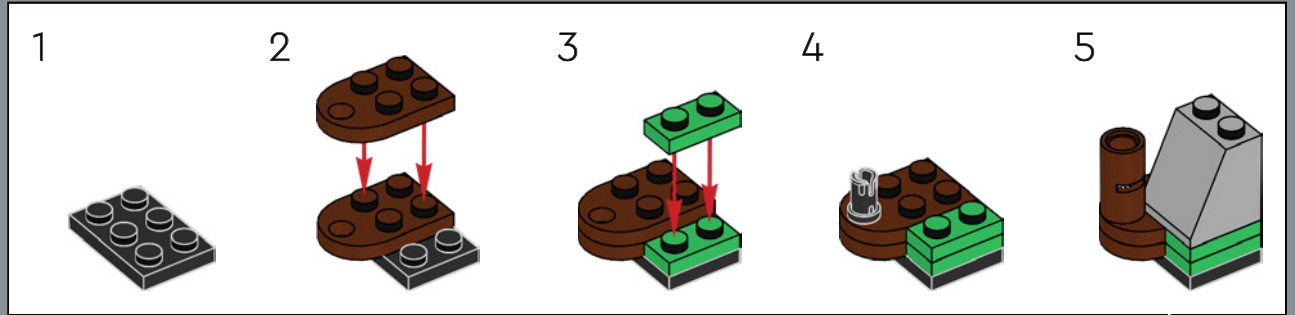

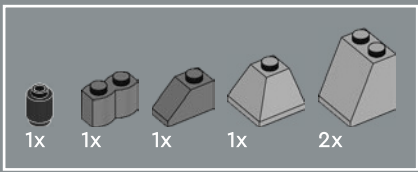

32

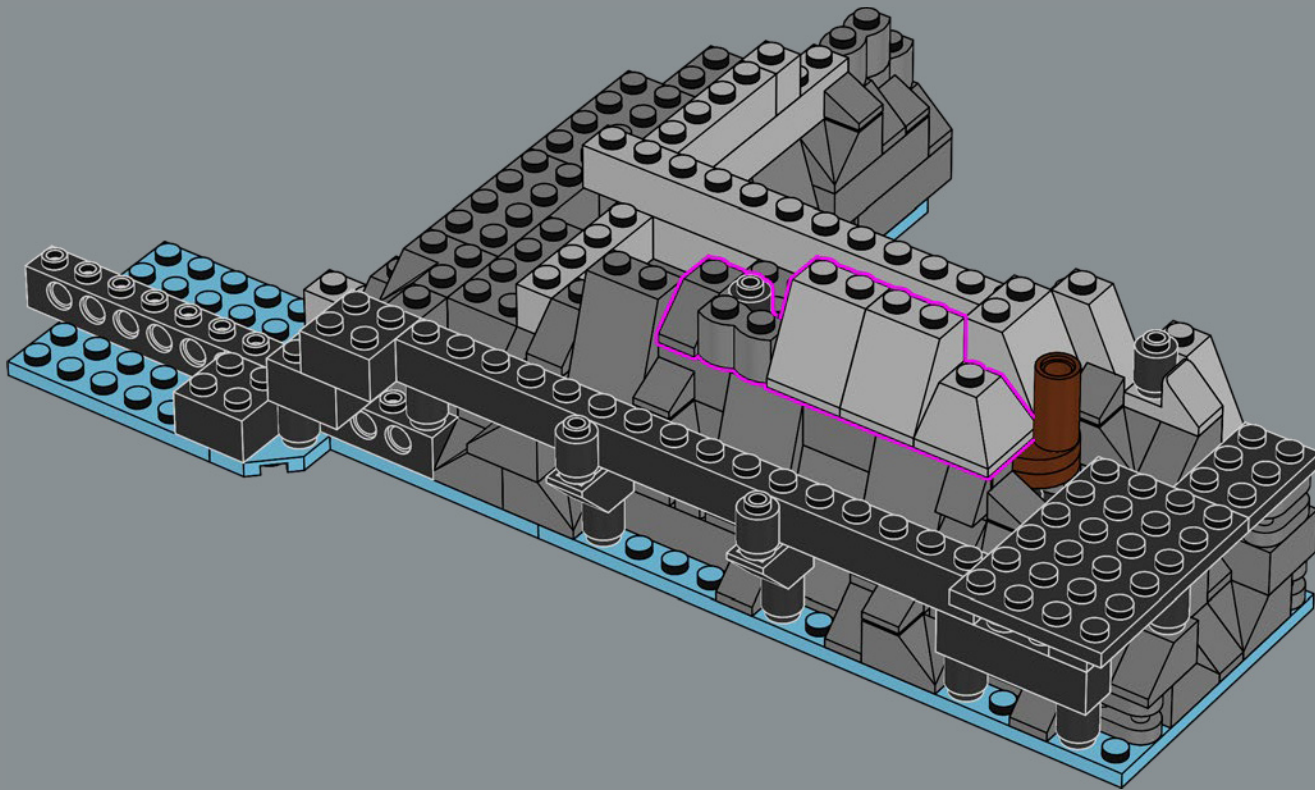



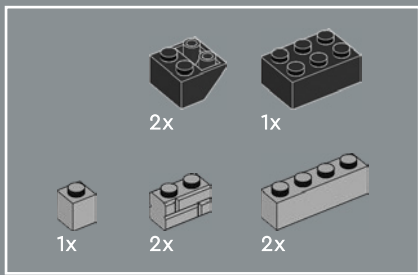

33

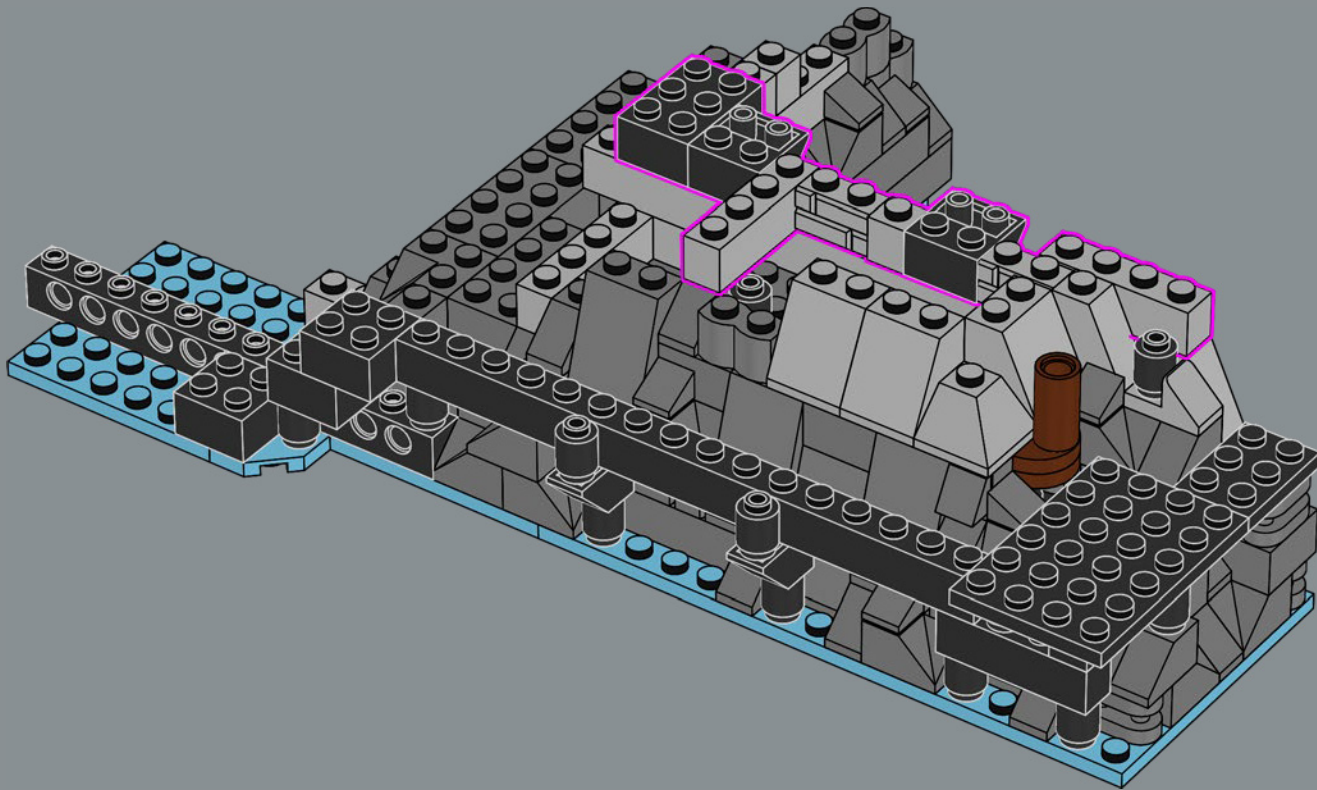

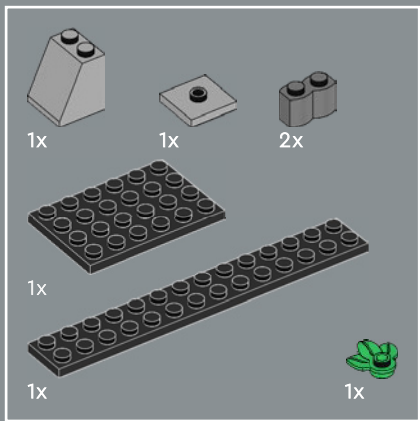

34

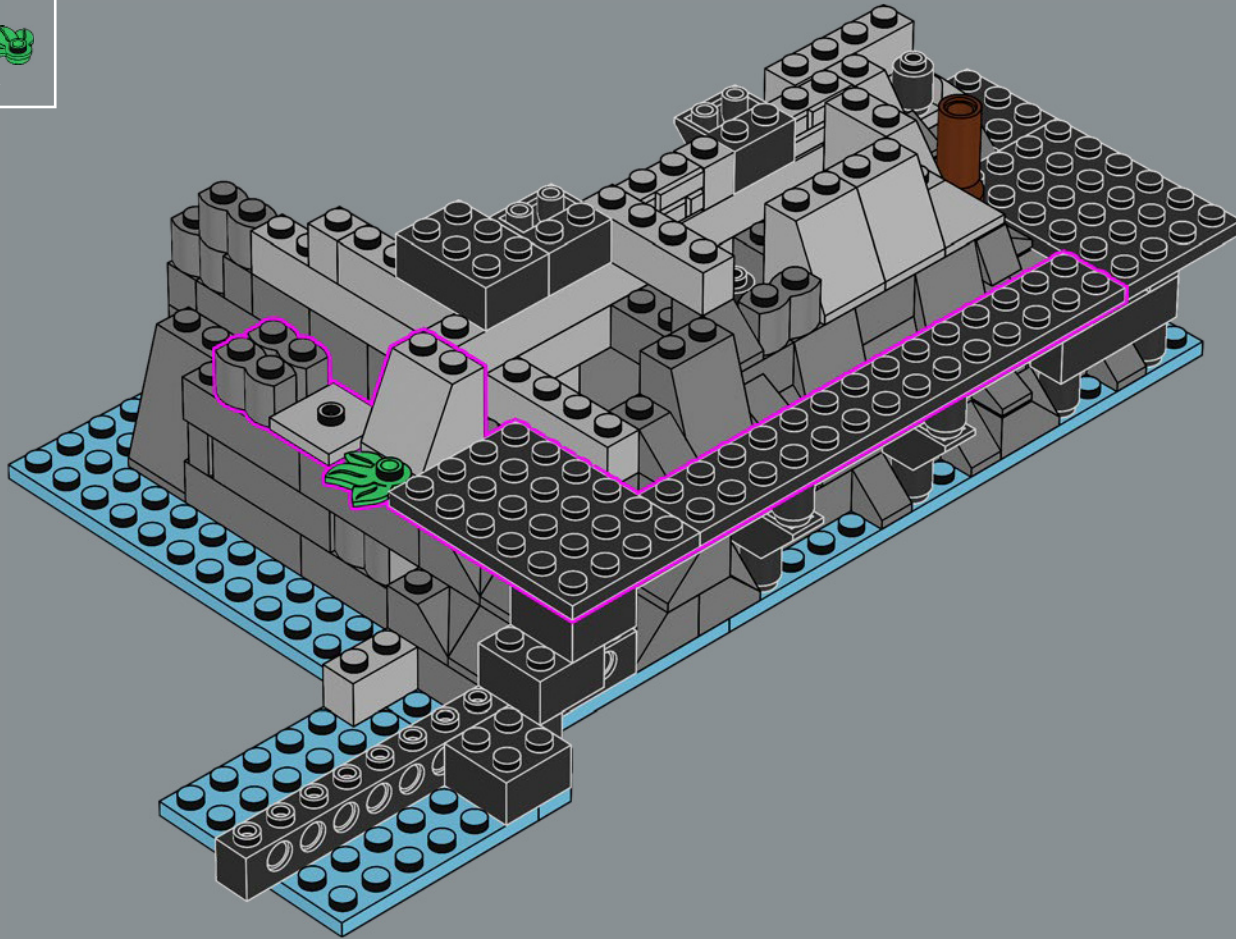

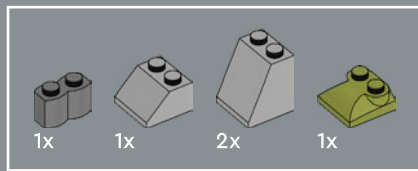

35

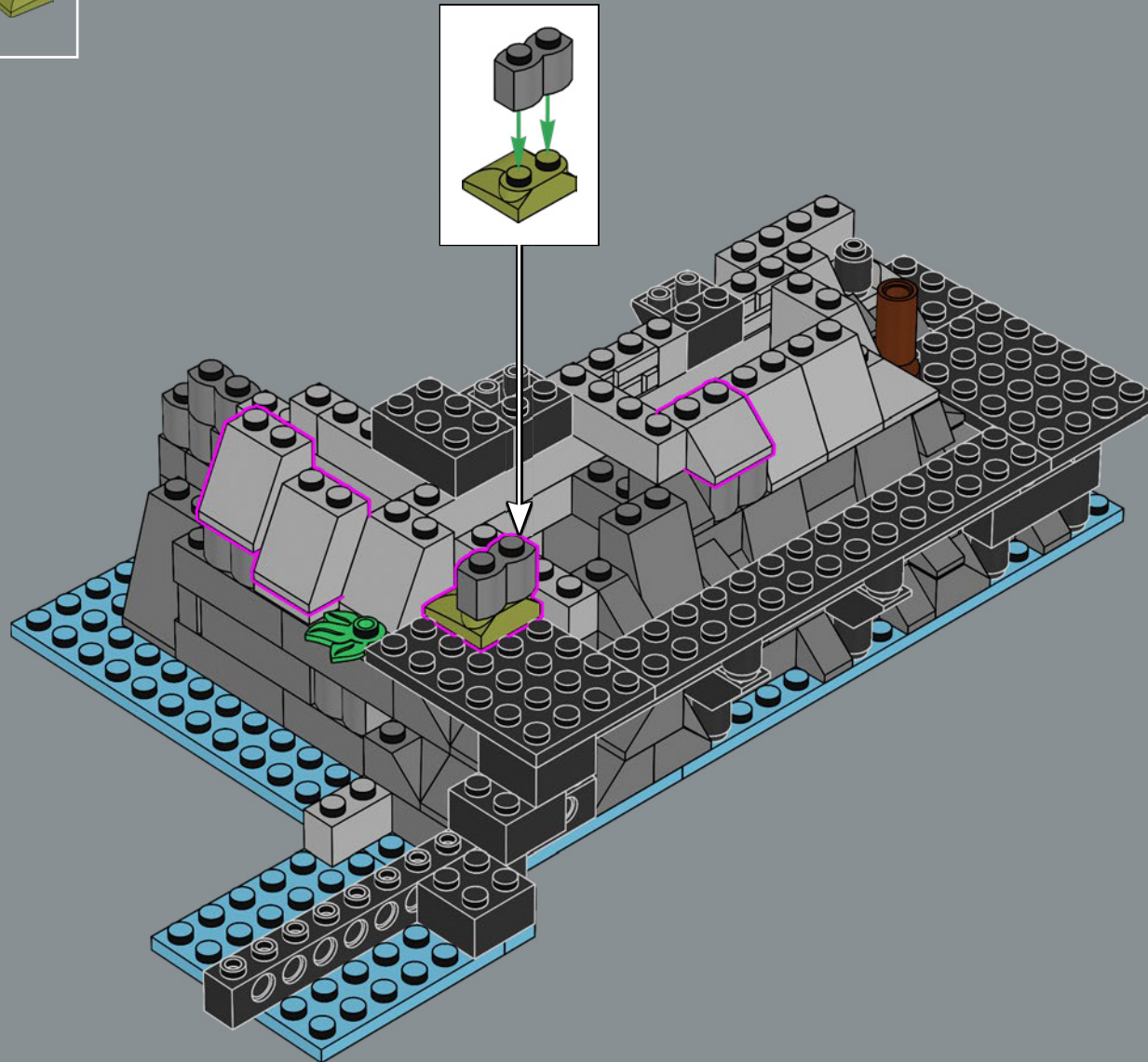

- 4x 
- 1x 
- 1x 

36

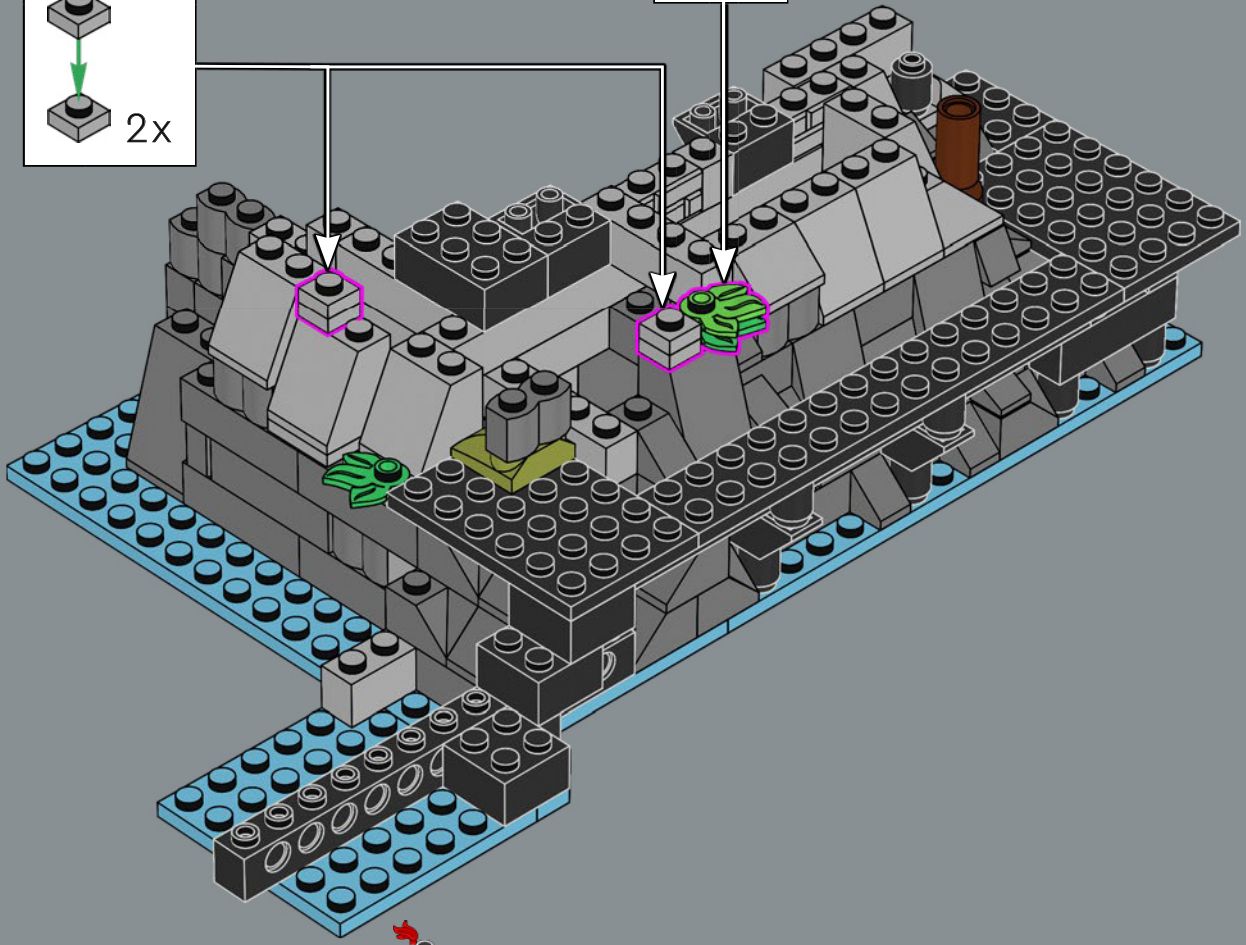
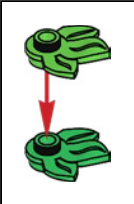
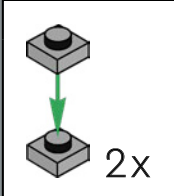



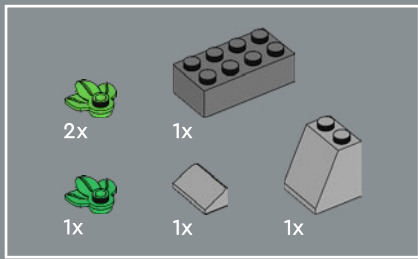

37

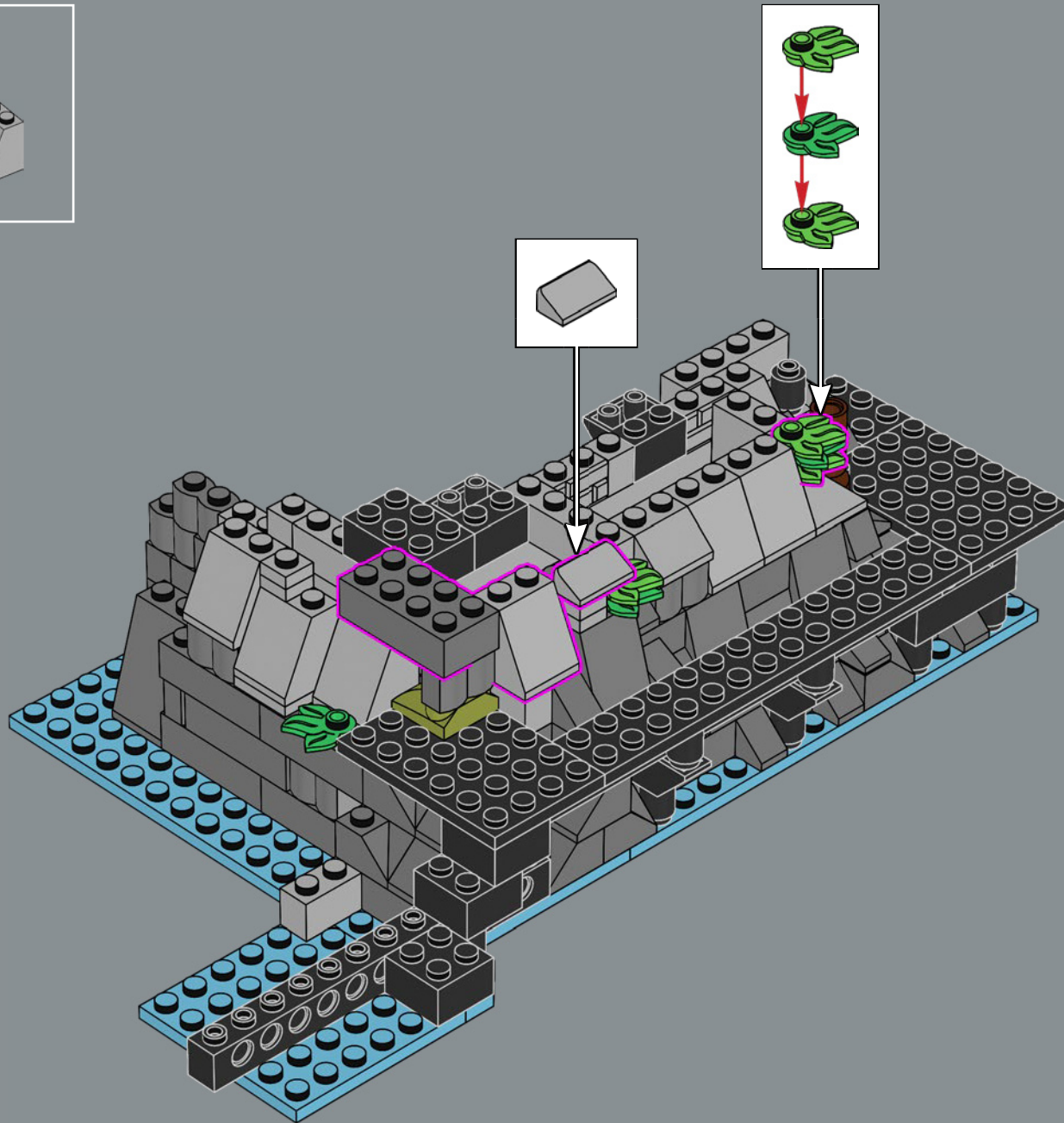

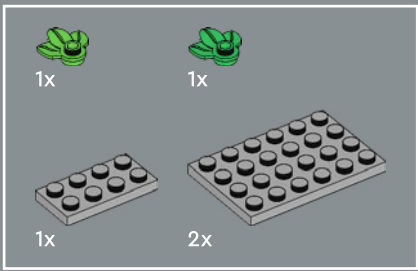

38

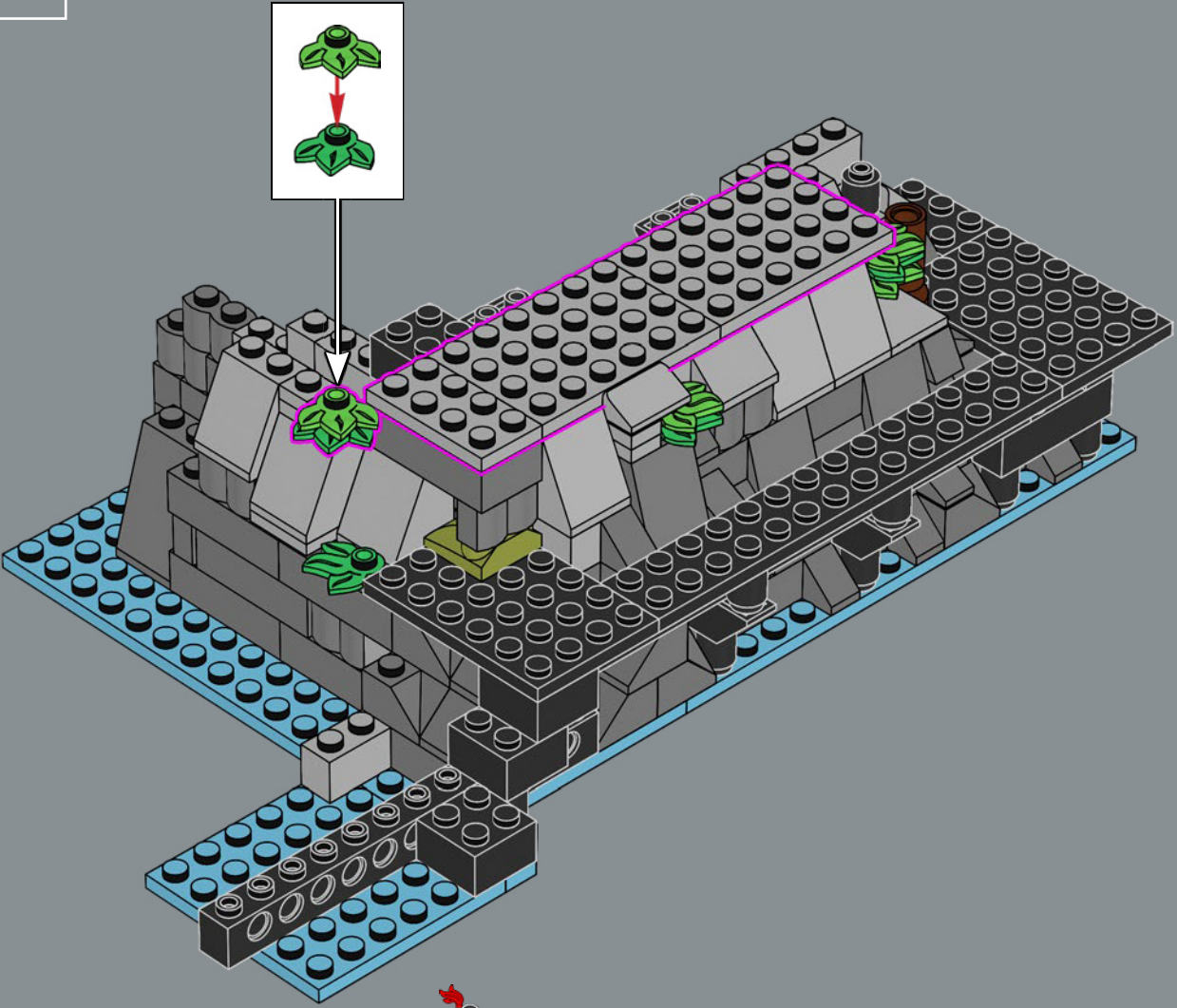

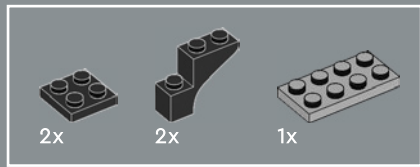

39

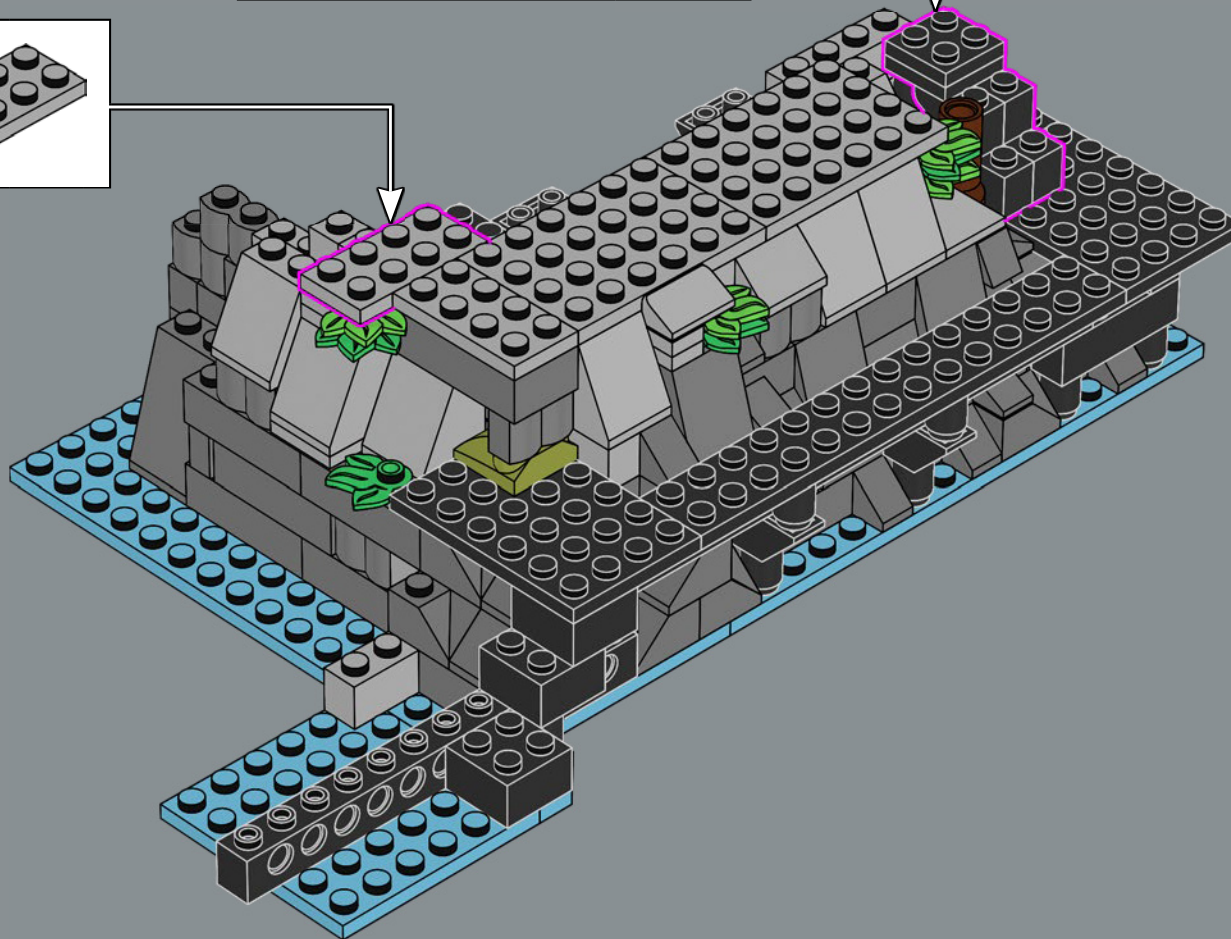
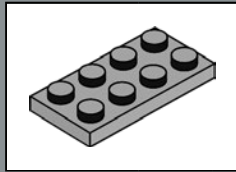
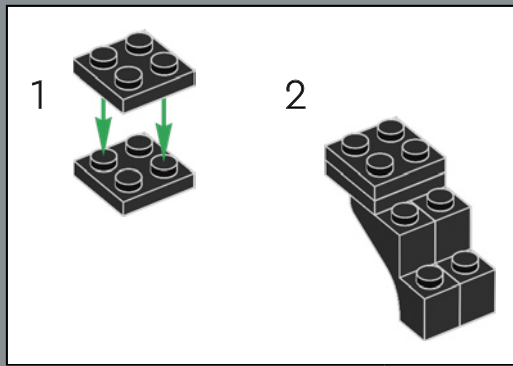



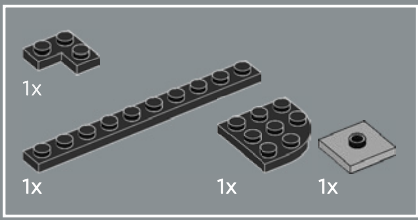

40

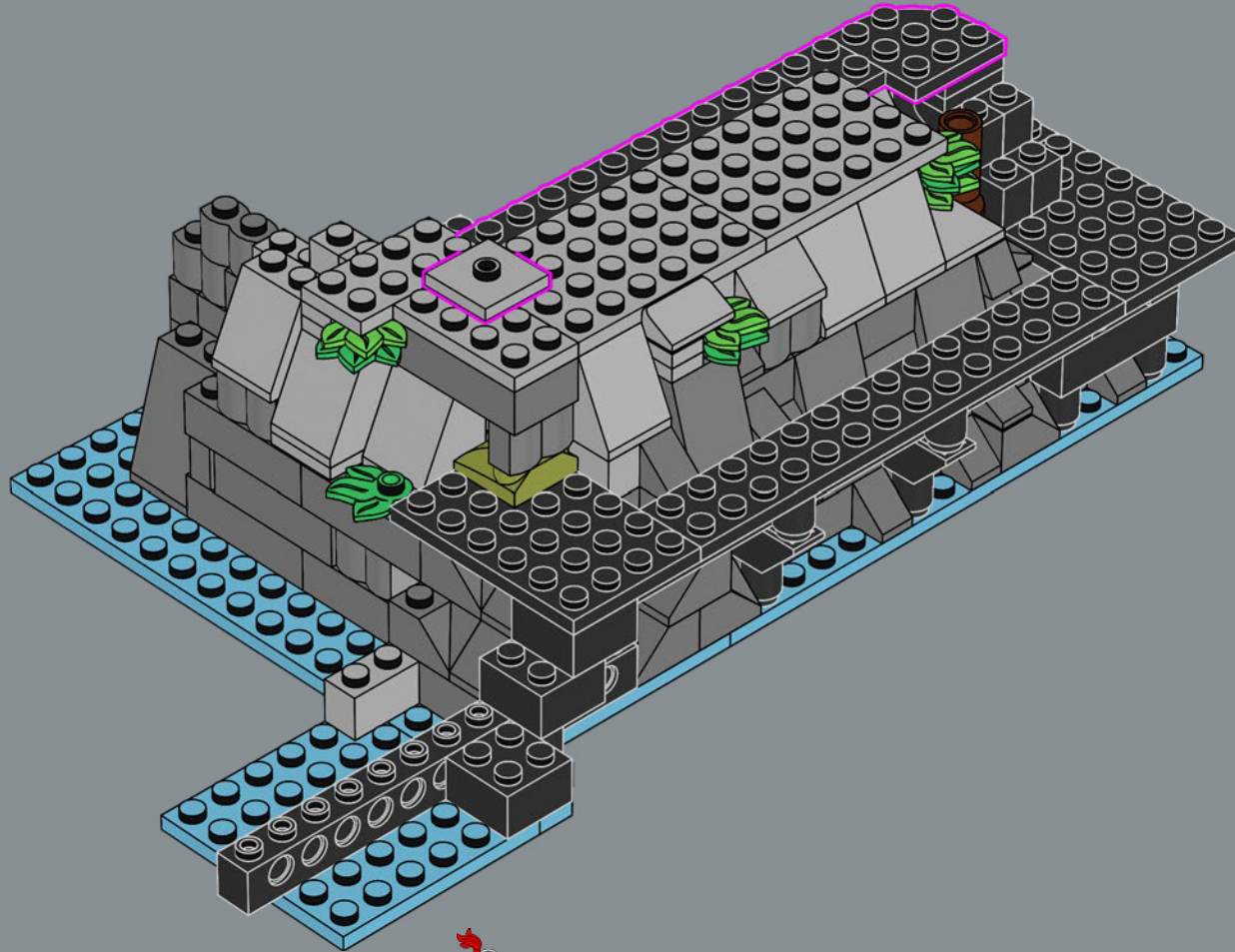



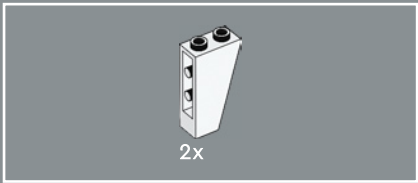

41

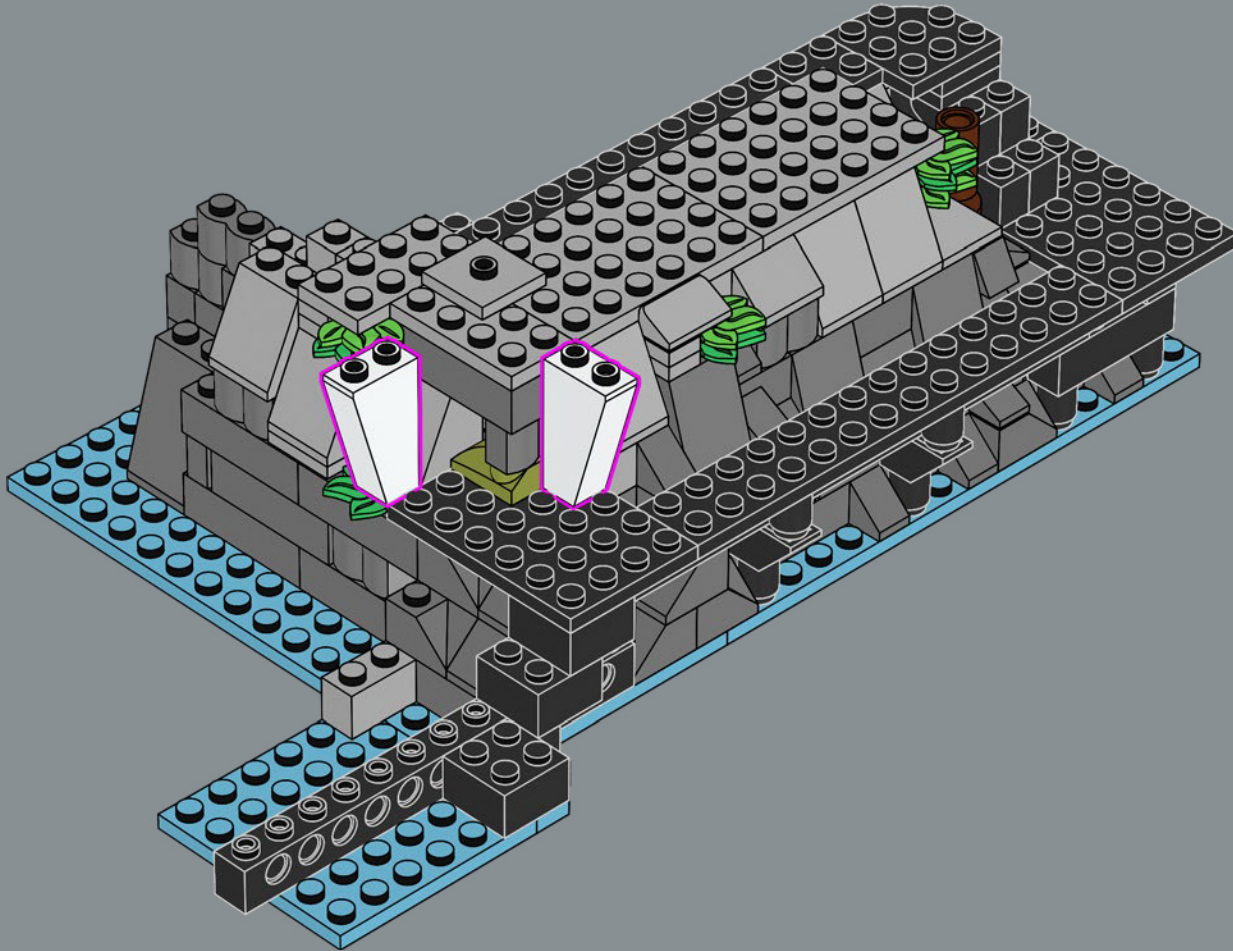

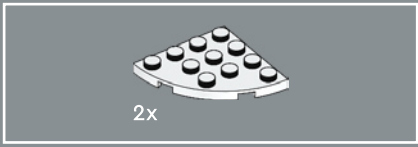

42

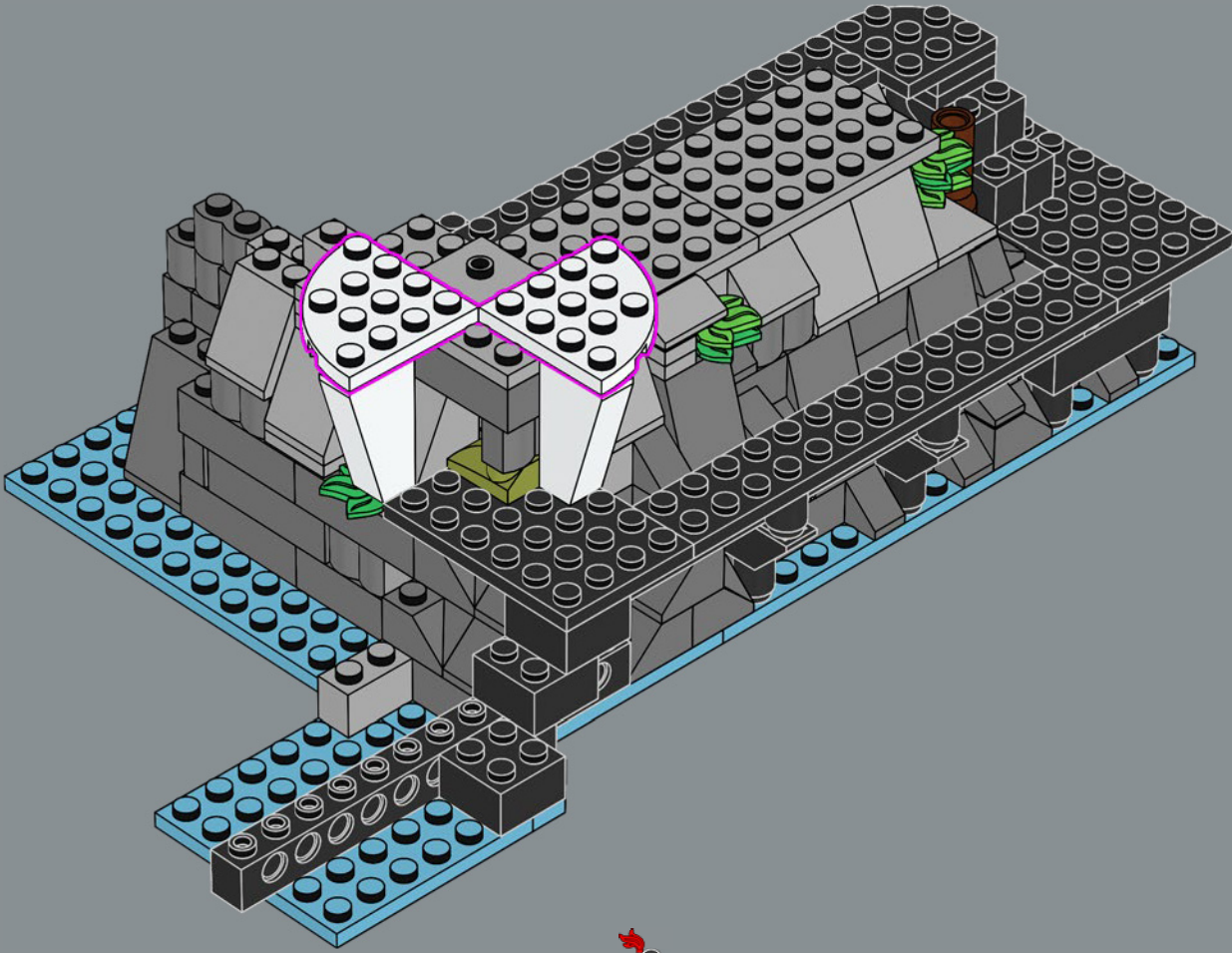

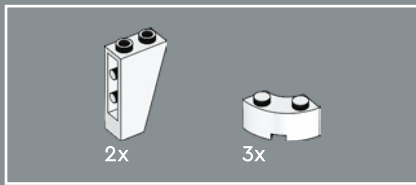

43

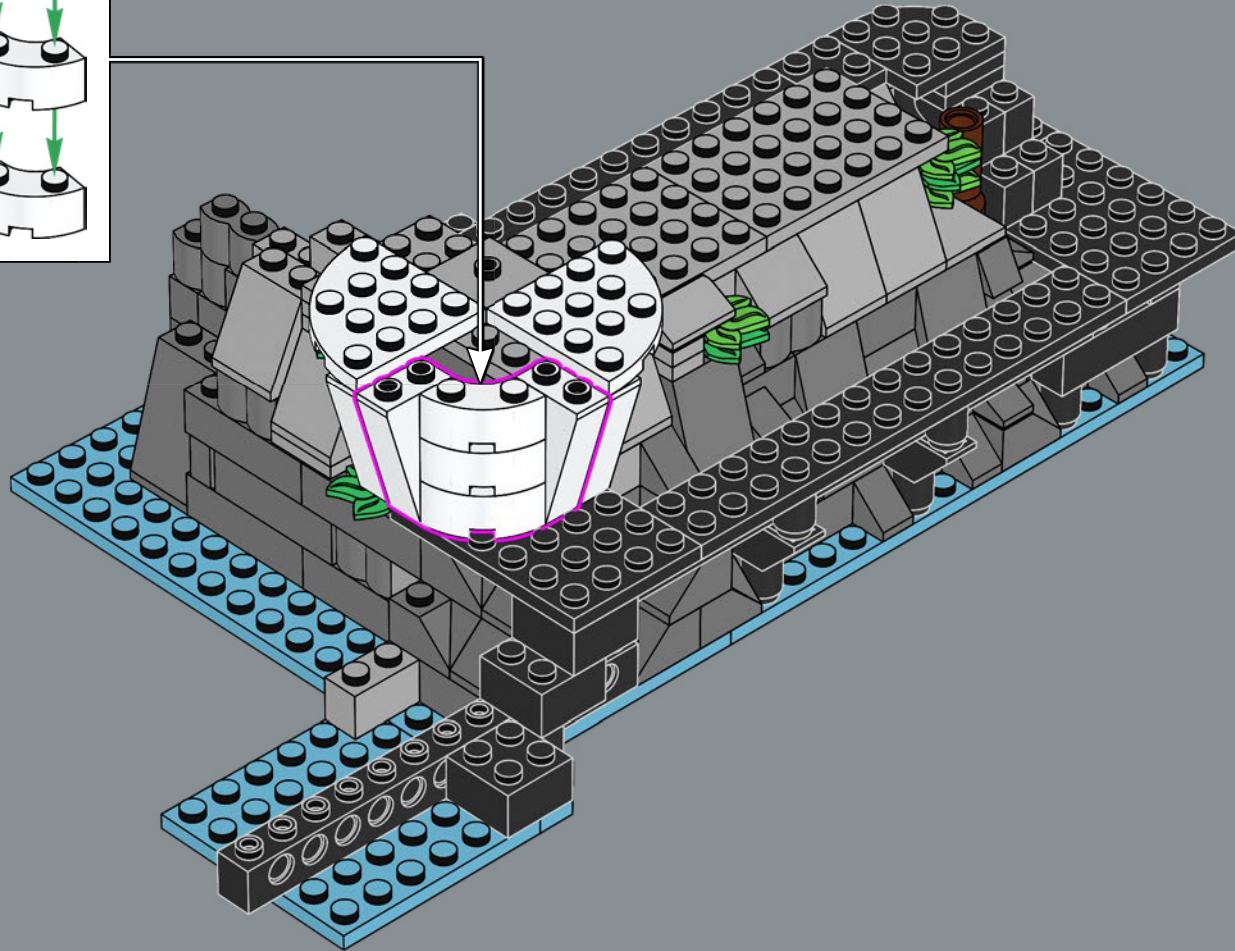
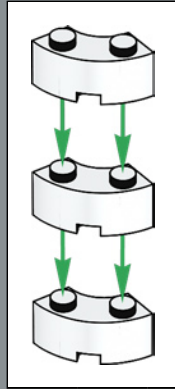





44

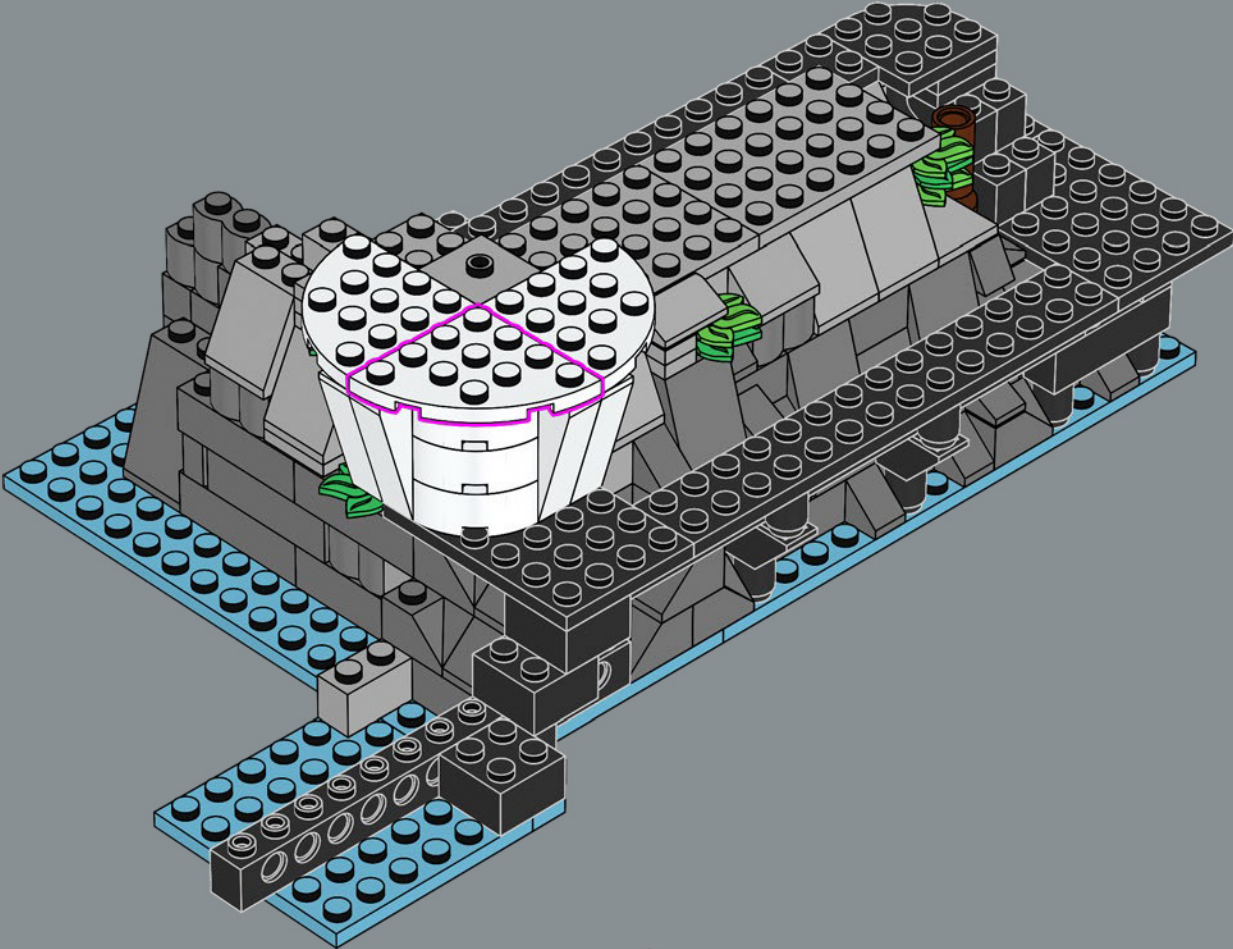



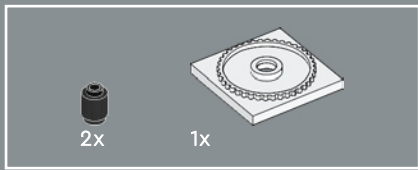

45

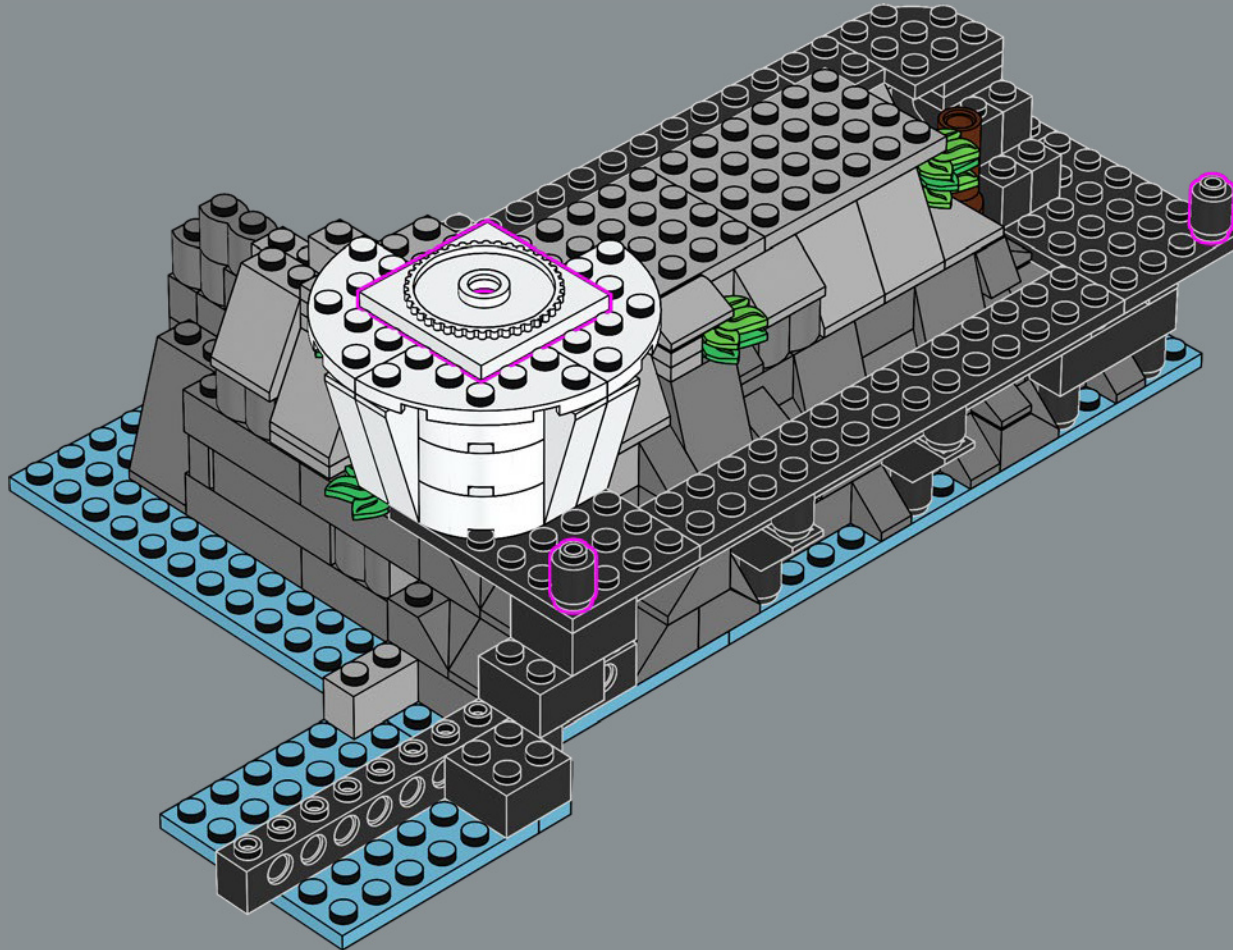

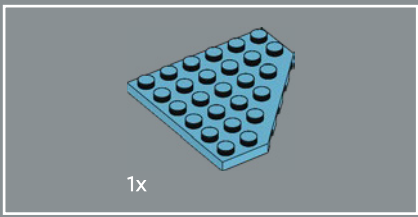

46

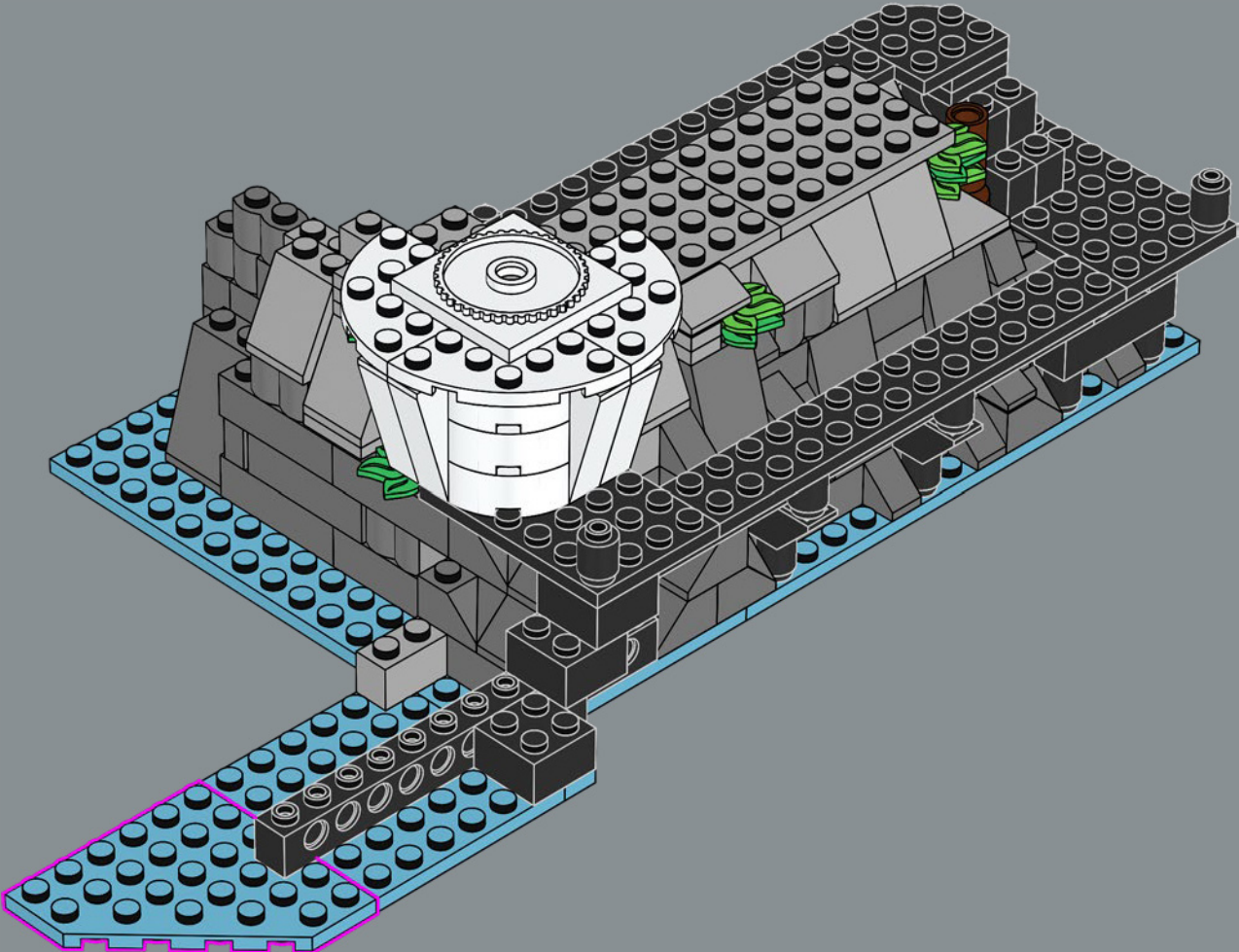

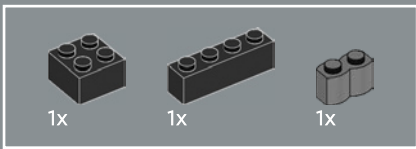

47

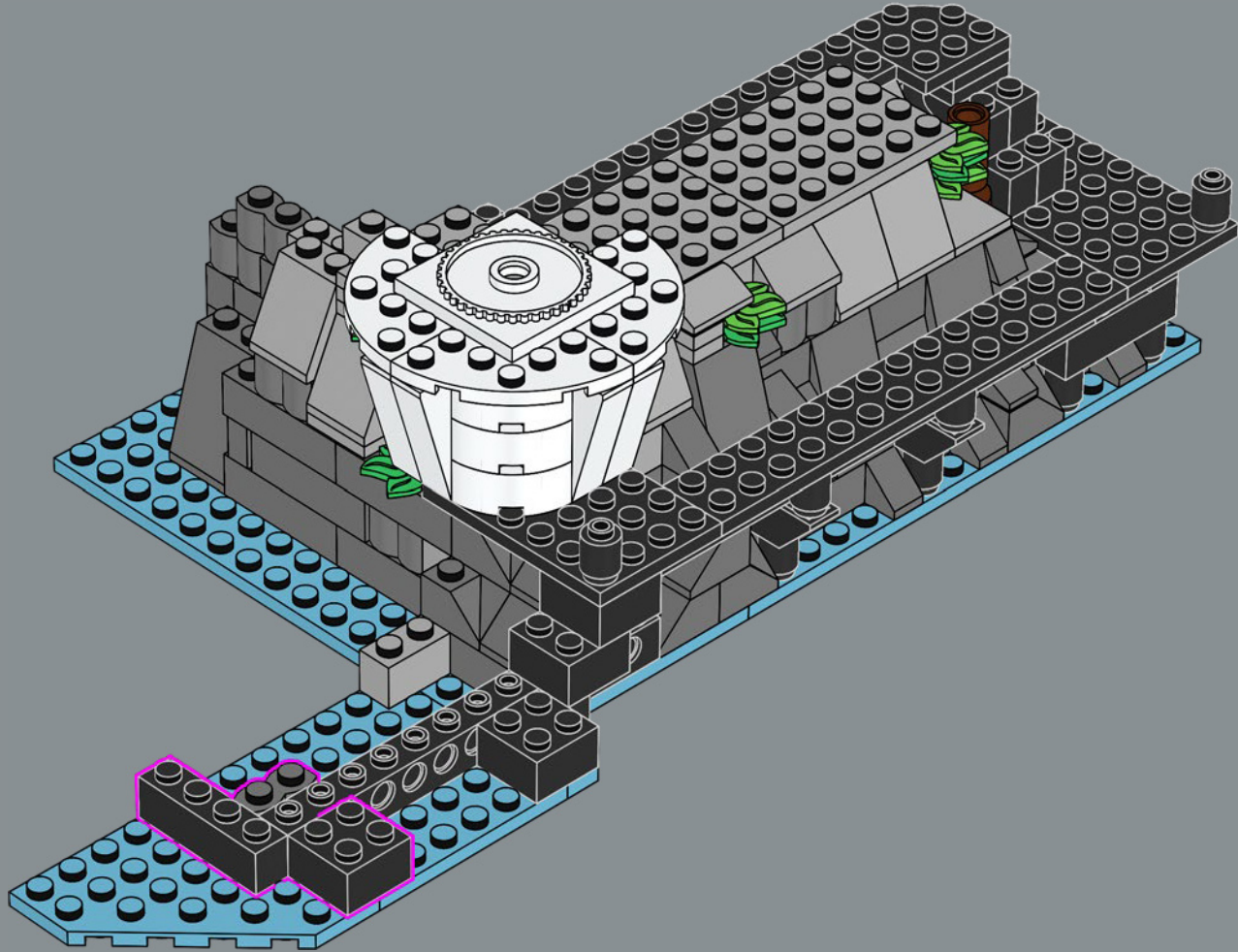



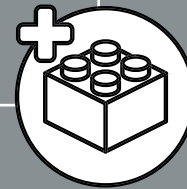
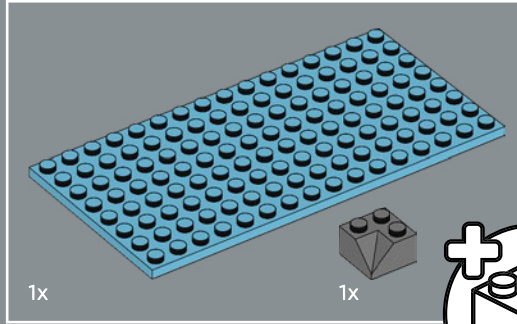
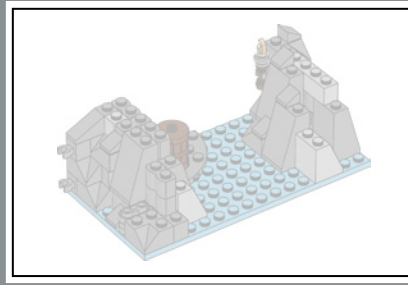
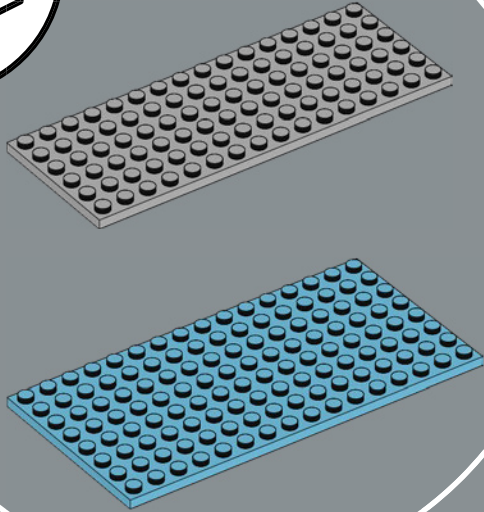
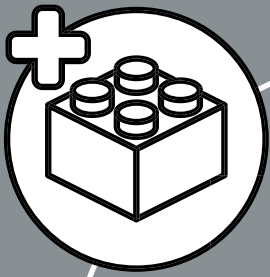

48

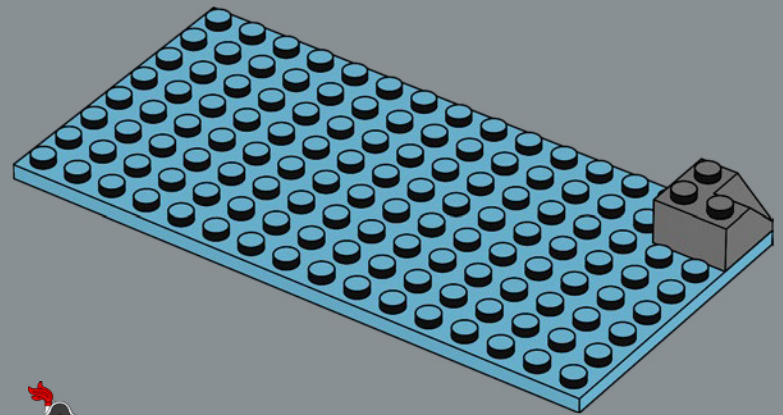





49

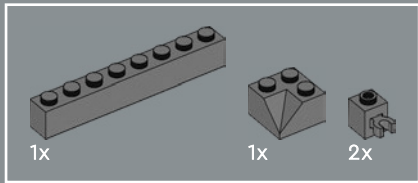
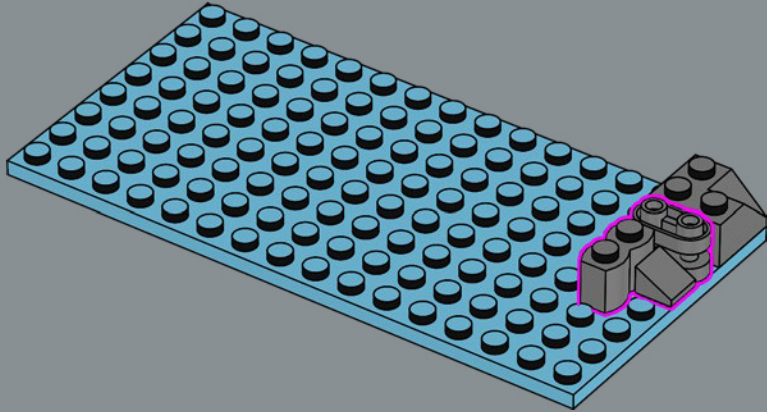

50

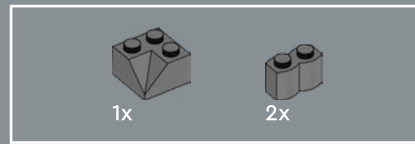
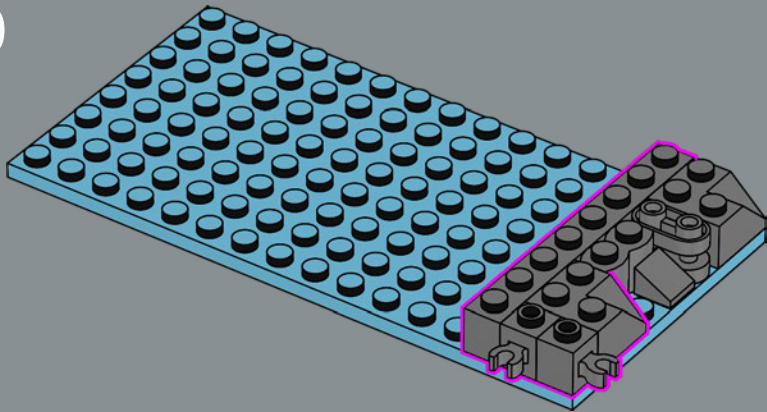

51

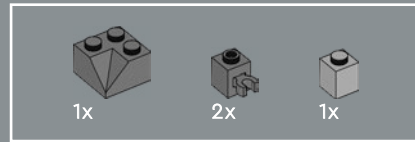
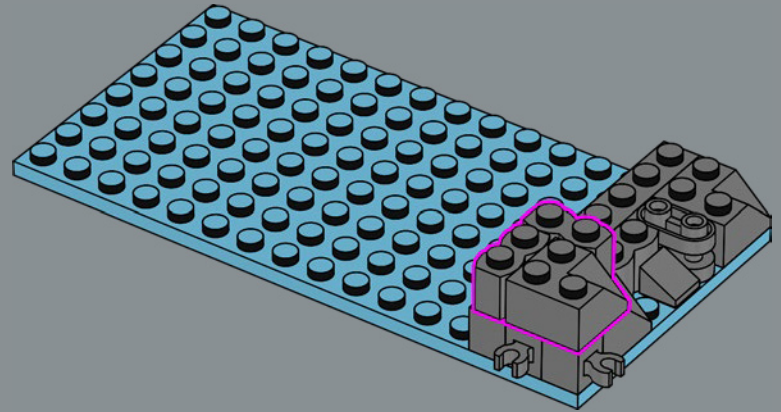

52

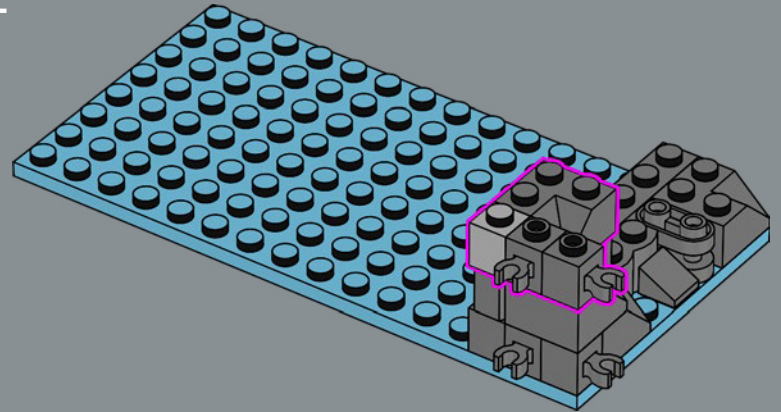

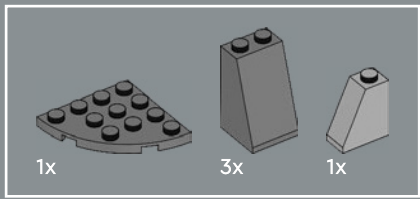

53

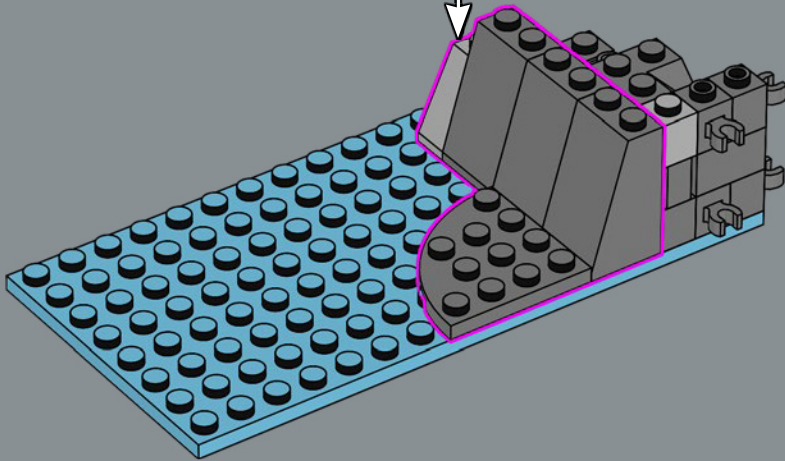
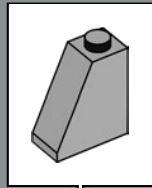

54

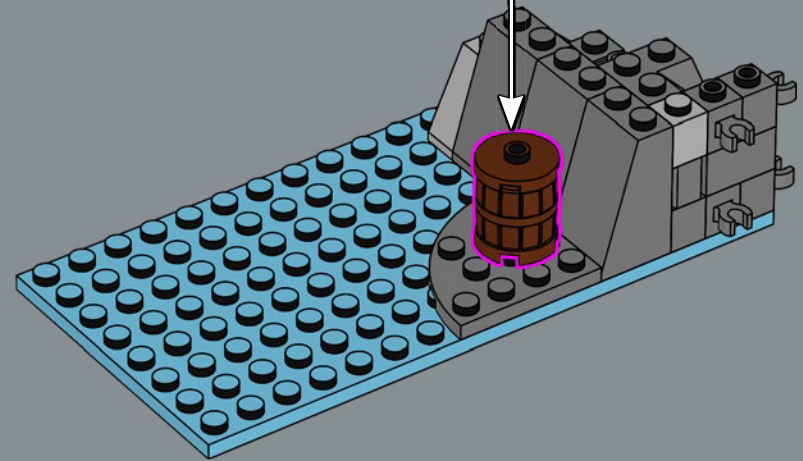
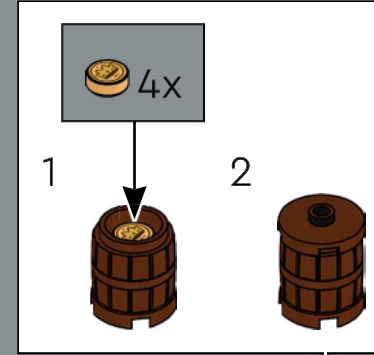

Golddublonen werden an einem sicheren Ort aufbewahrt, wo niemand sie finden kann.



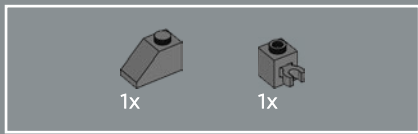

55

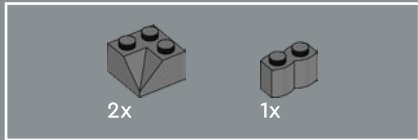
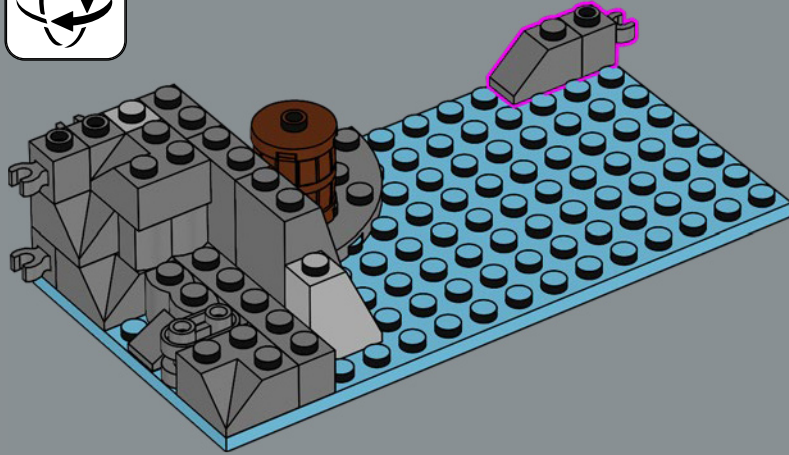

56

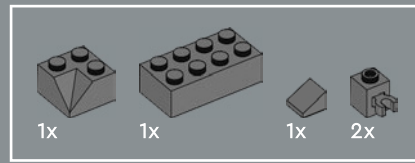
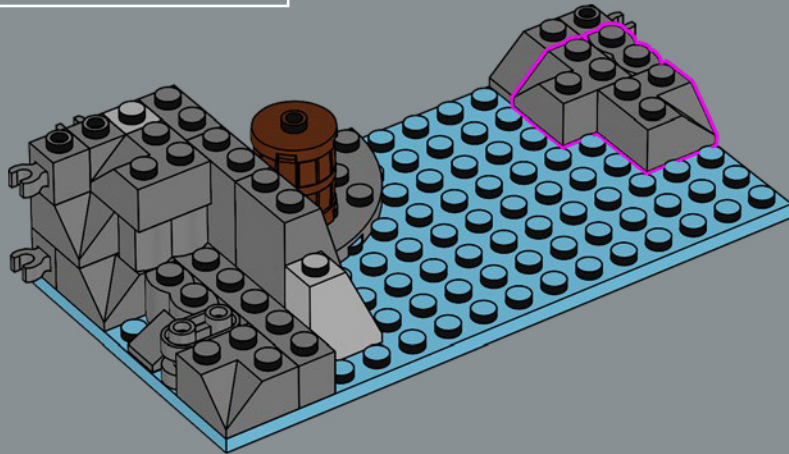

57

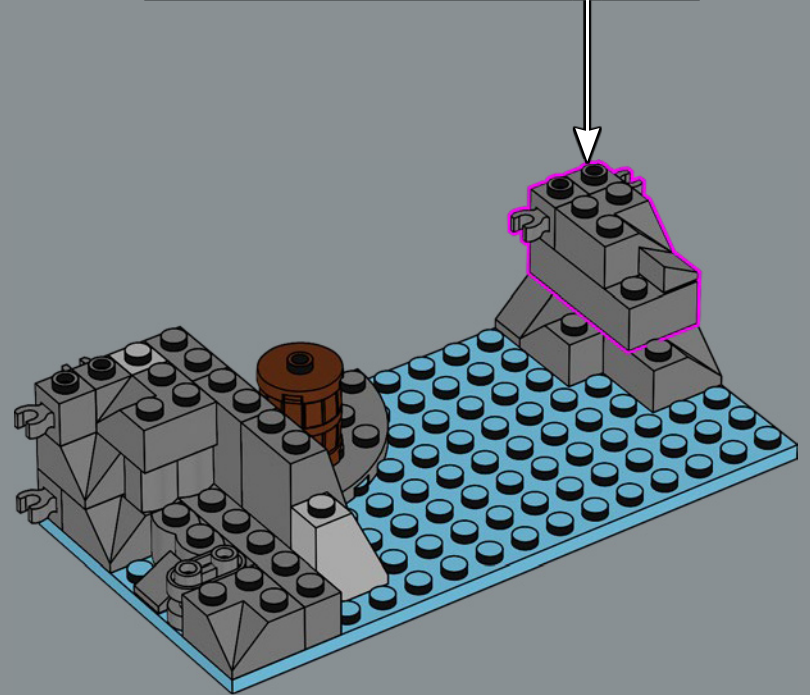
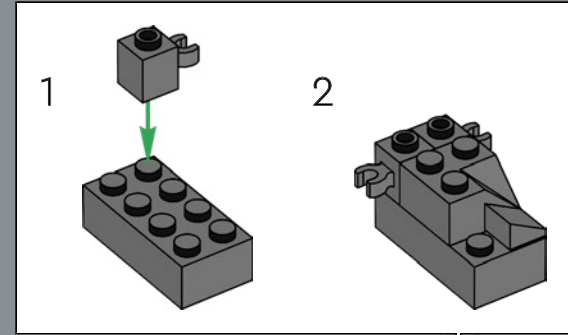



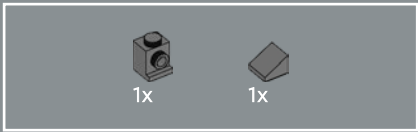

58

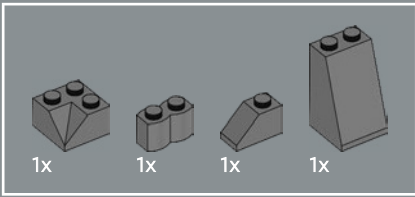
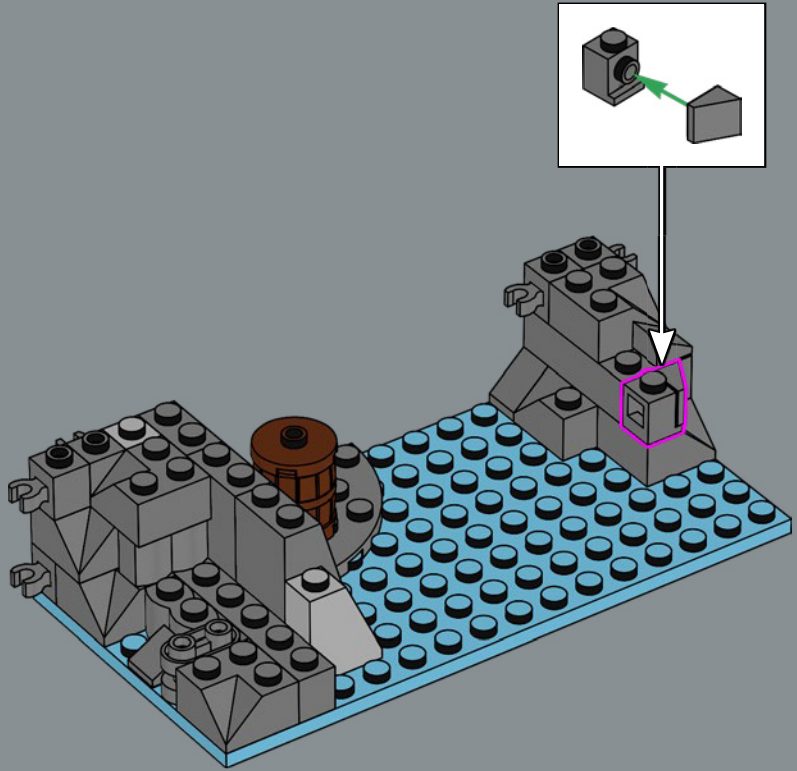
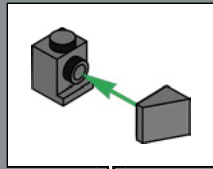

59

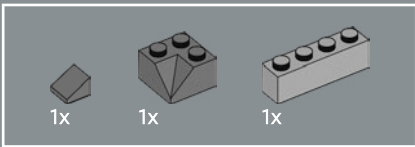
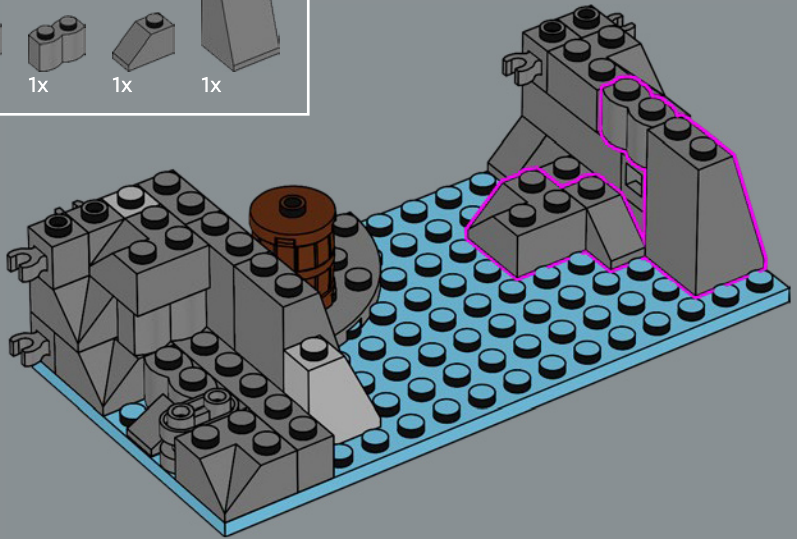

60

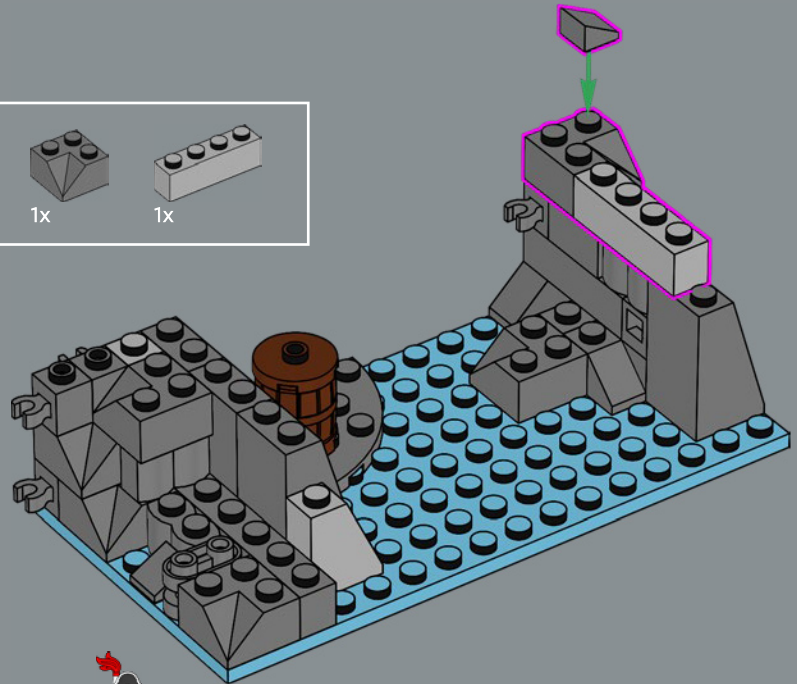



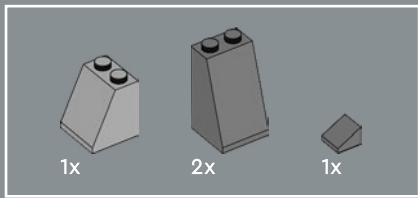

61

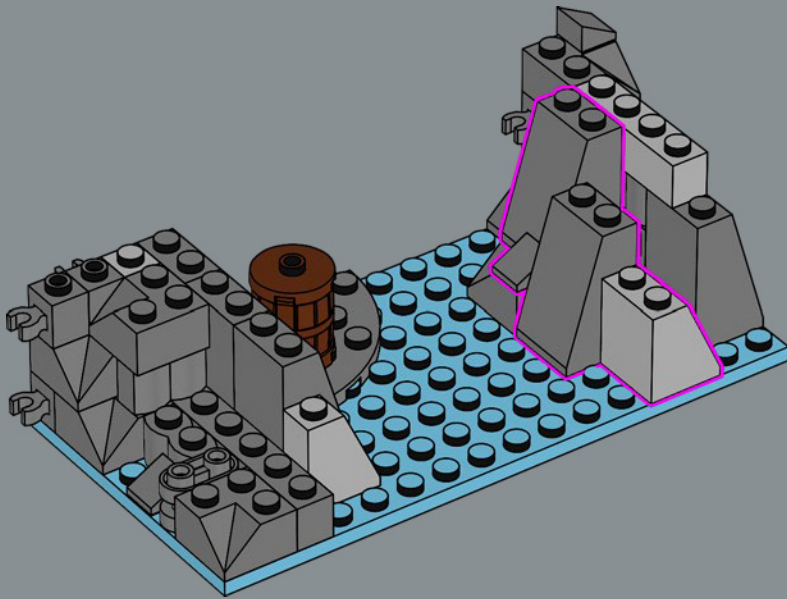

62

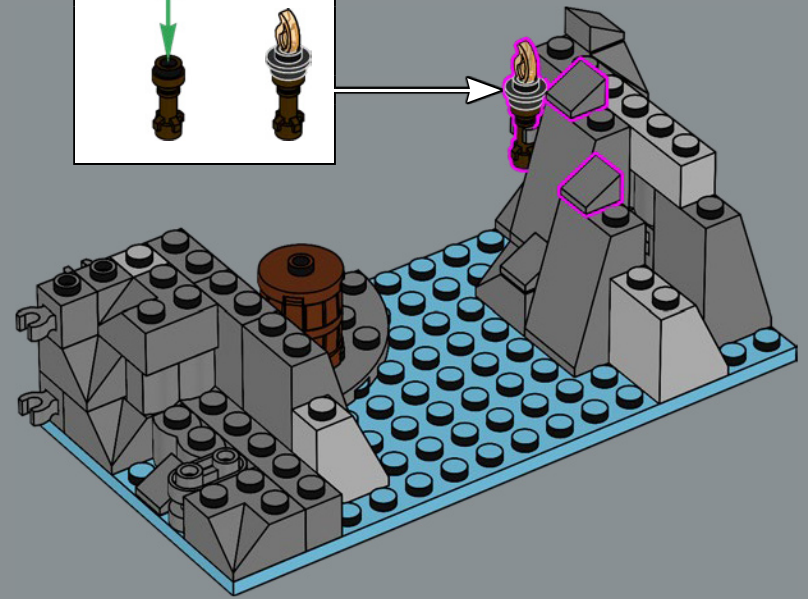
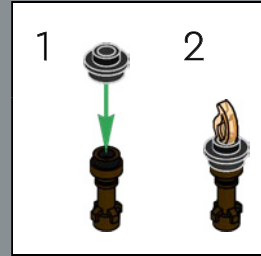

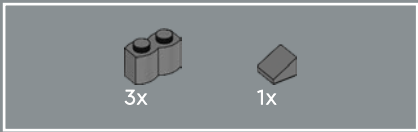

63

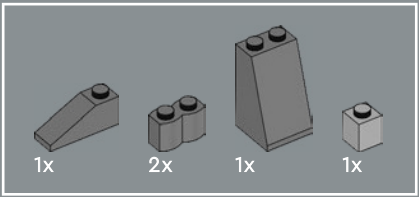
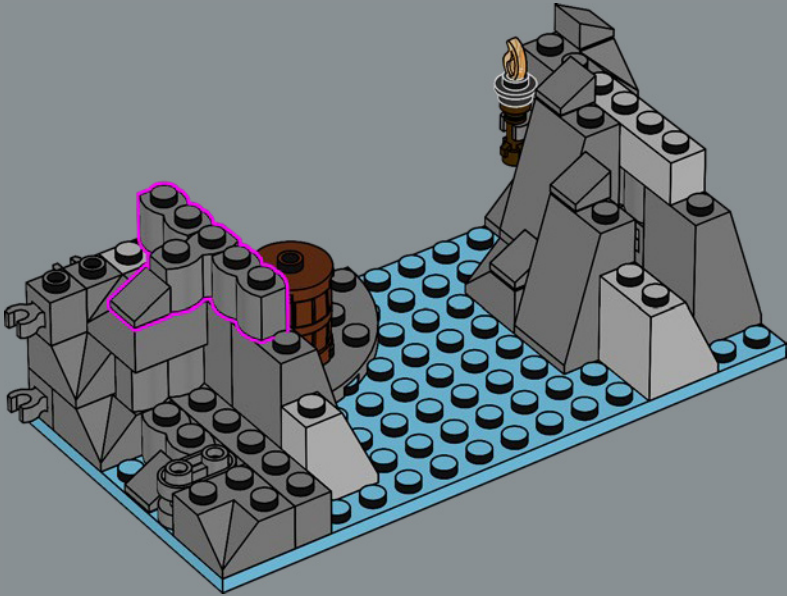

64

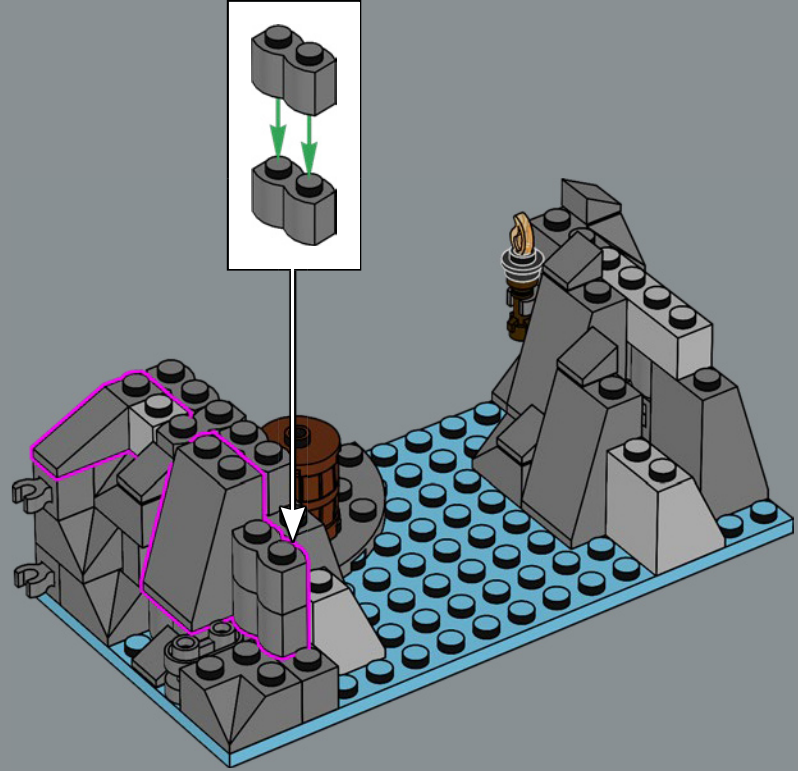

65

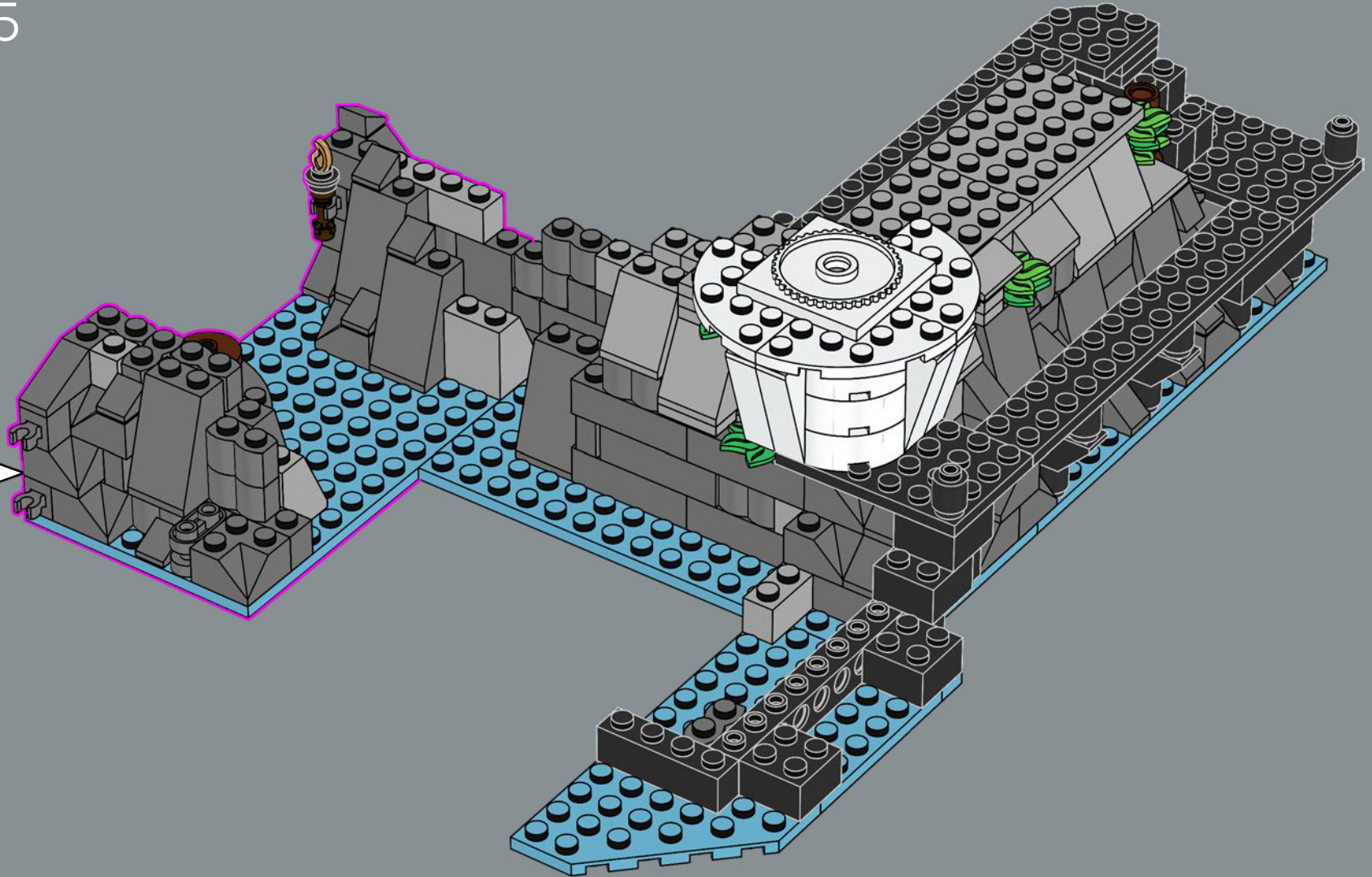



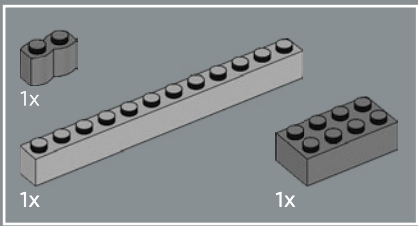

66

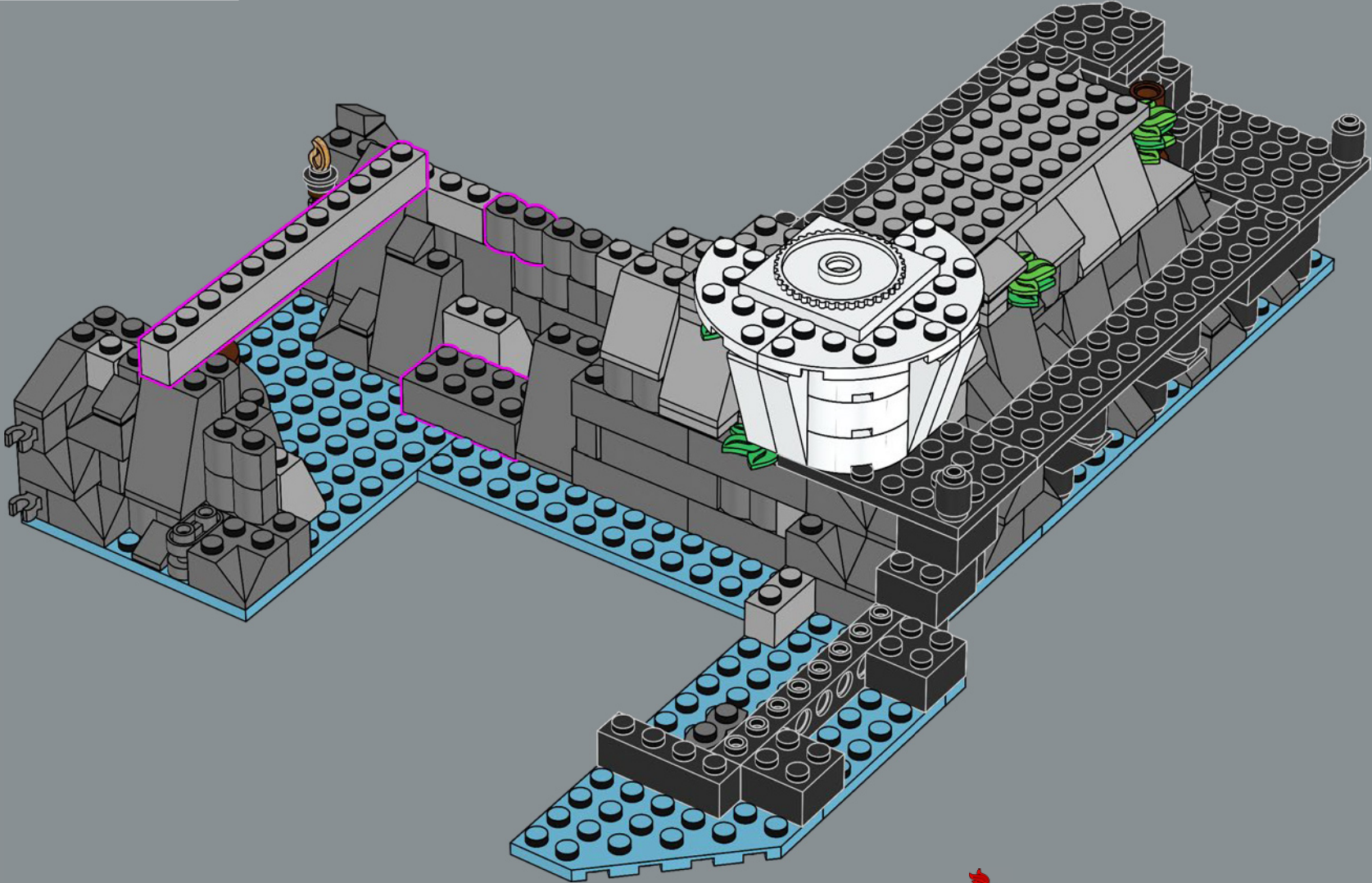



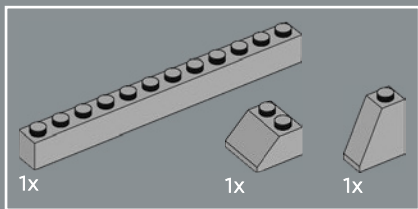

67

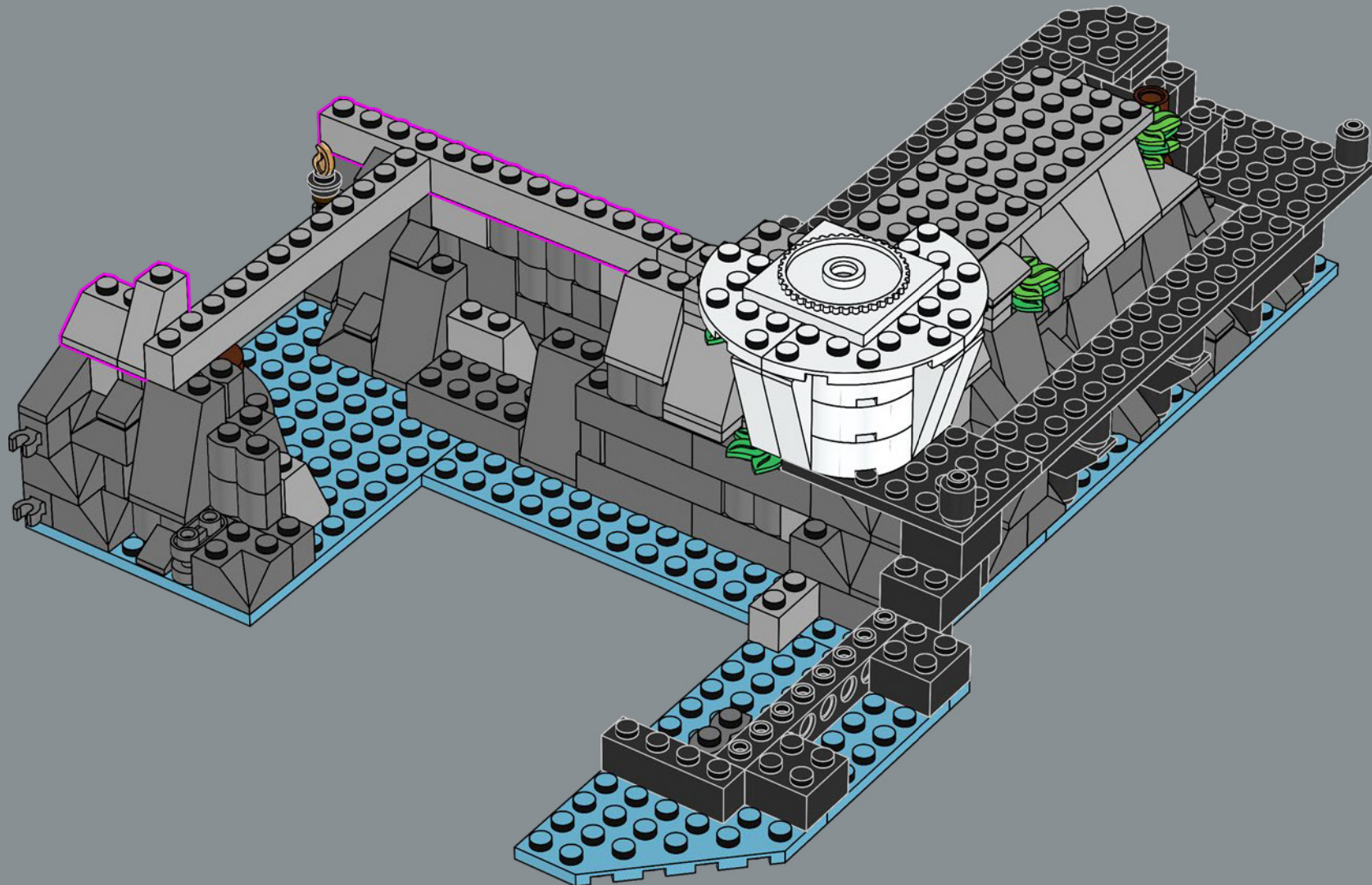

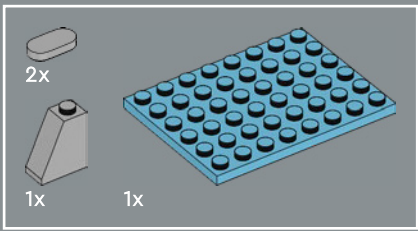

68

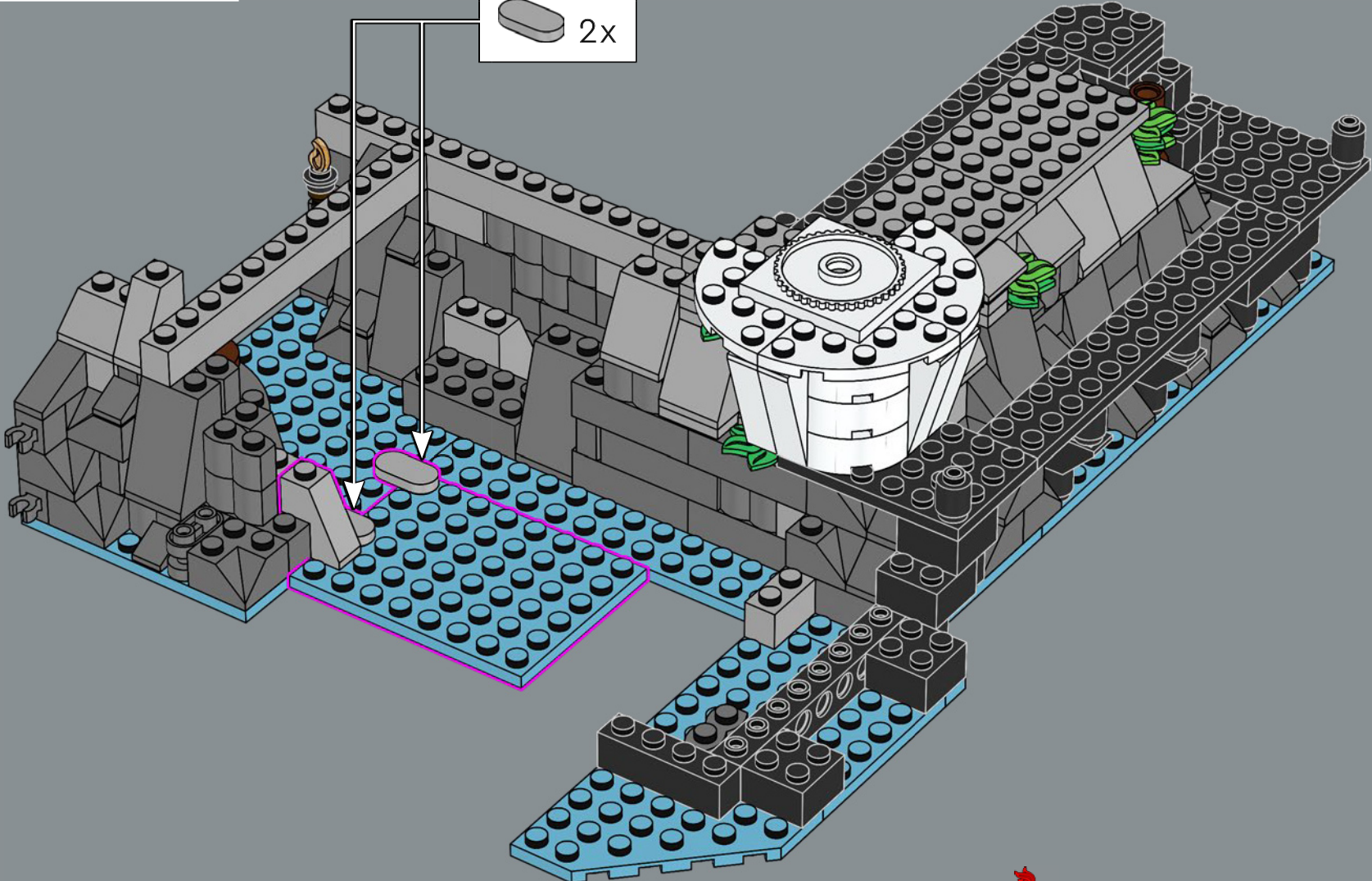



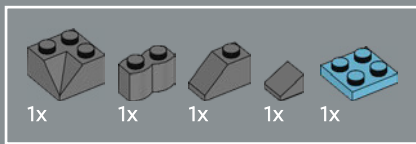

69

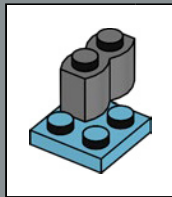
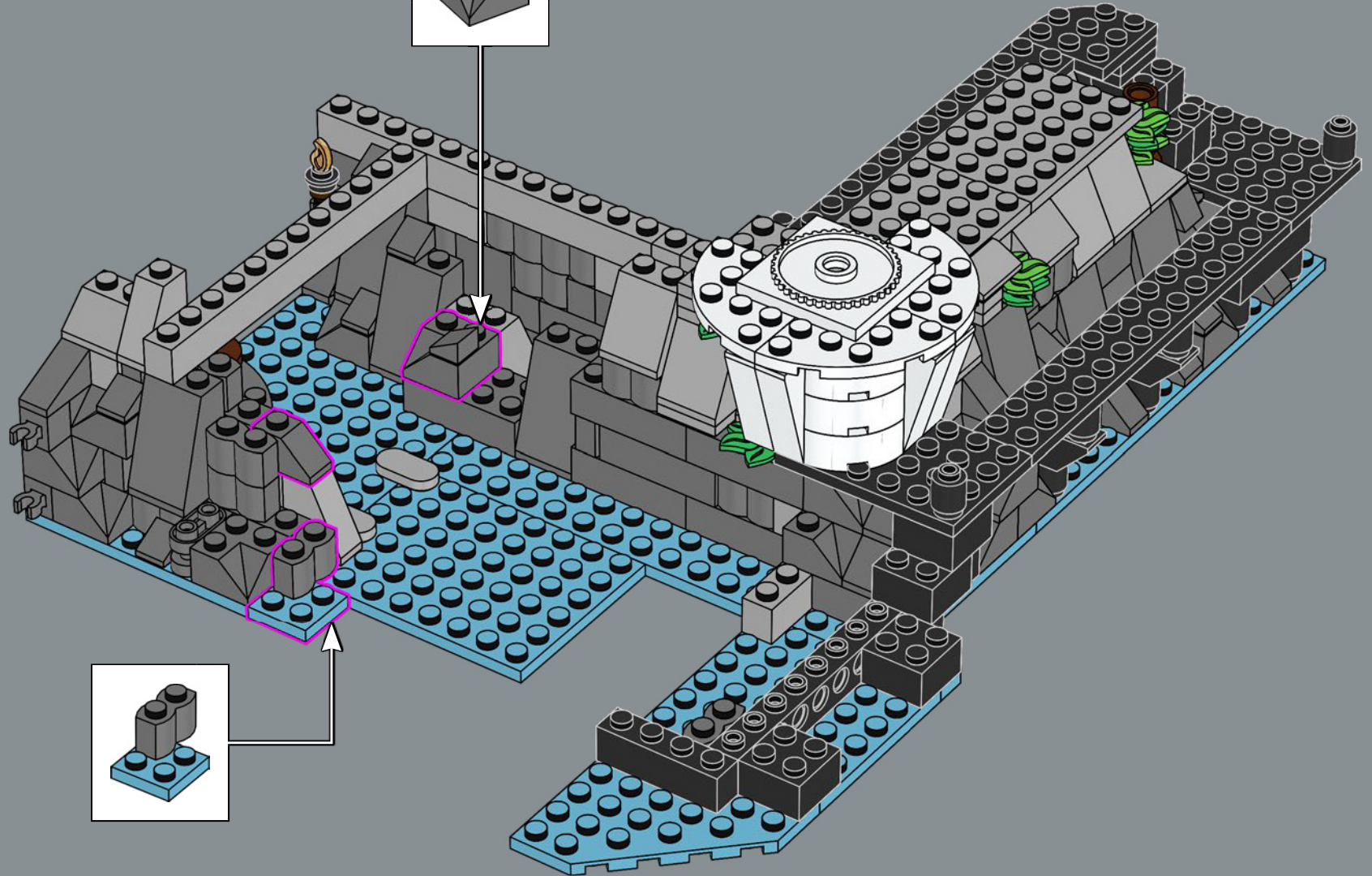
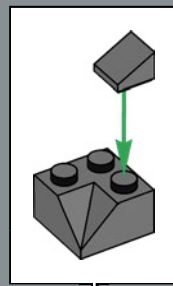

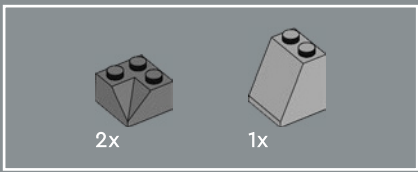

70

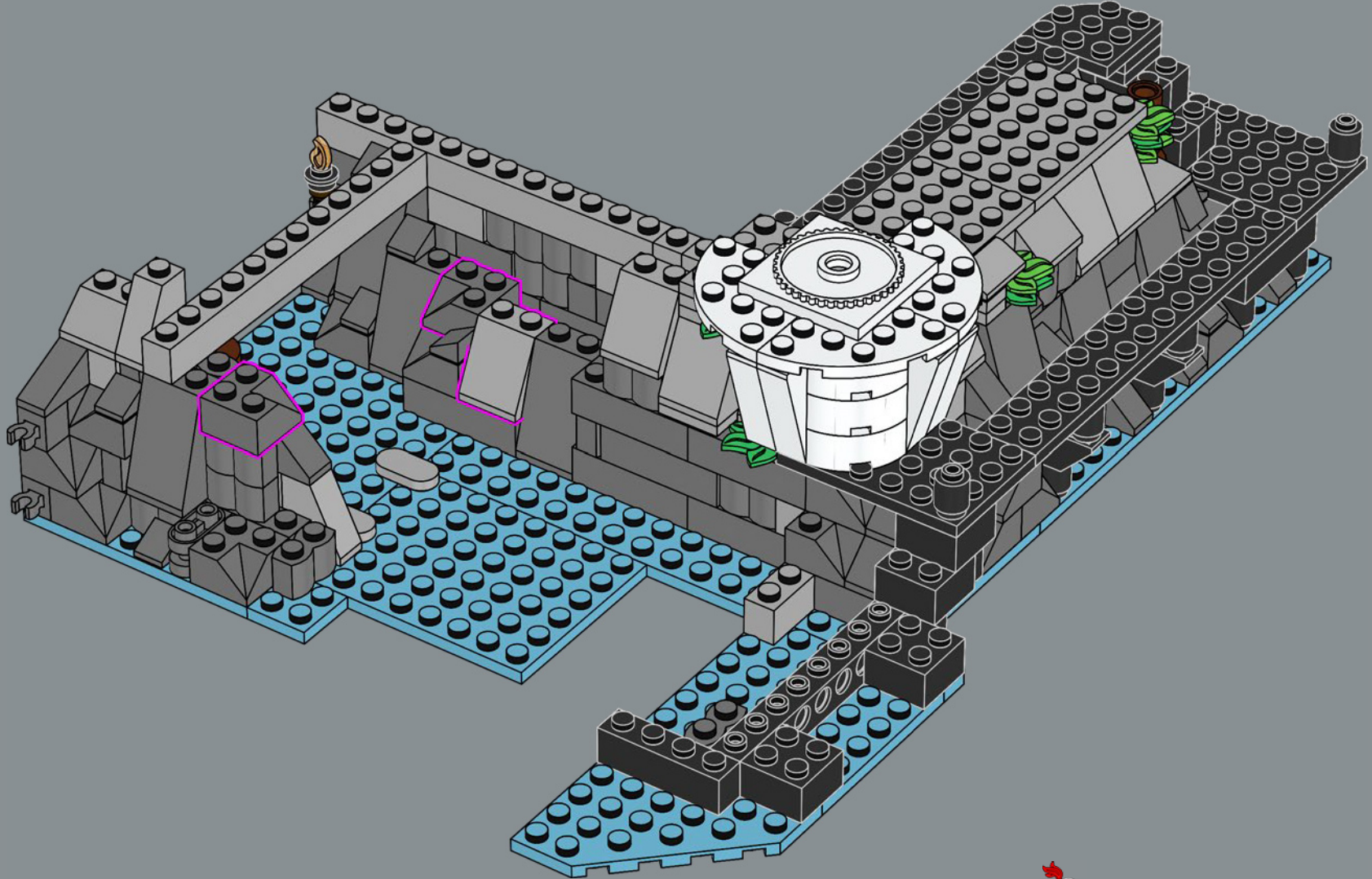





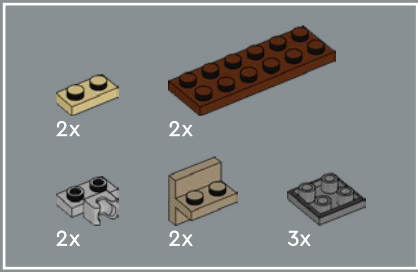

72

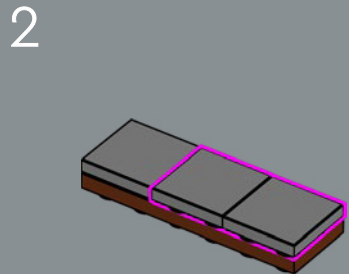
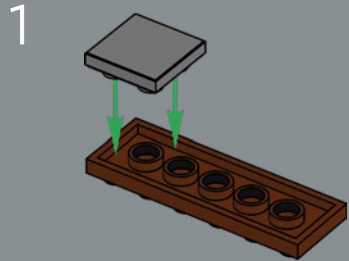

3

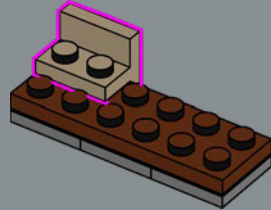

4

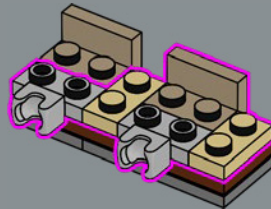

5

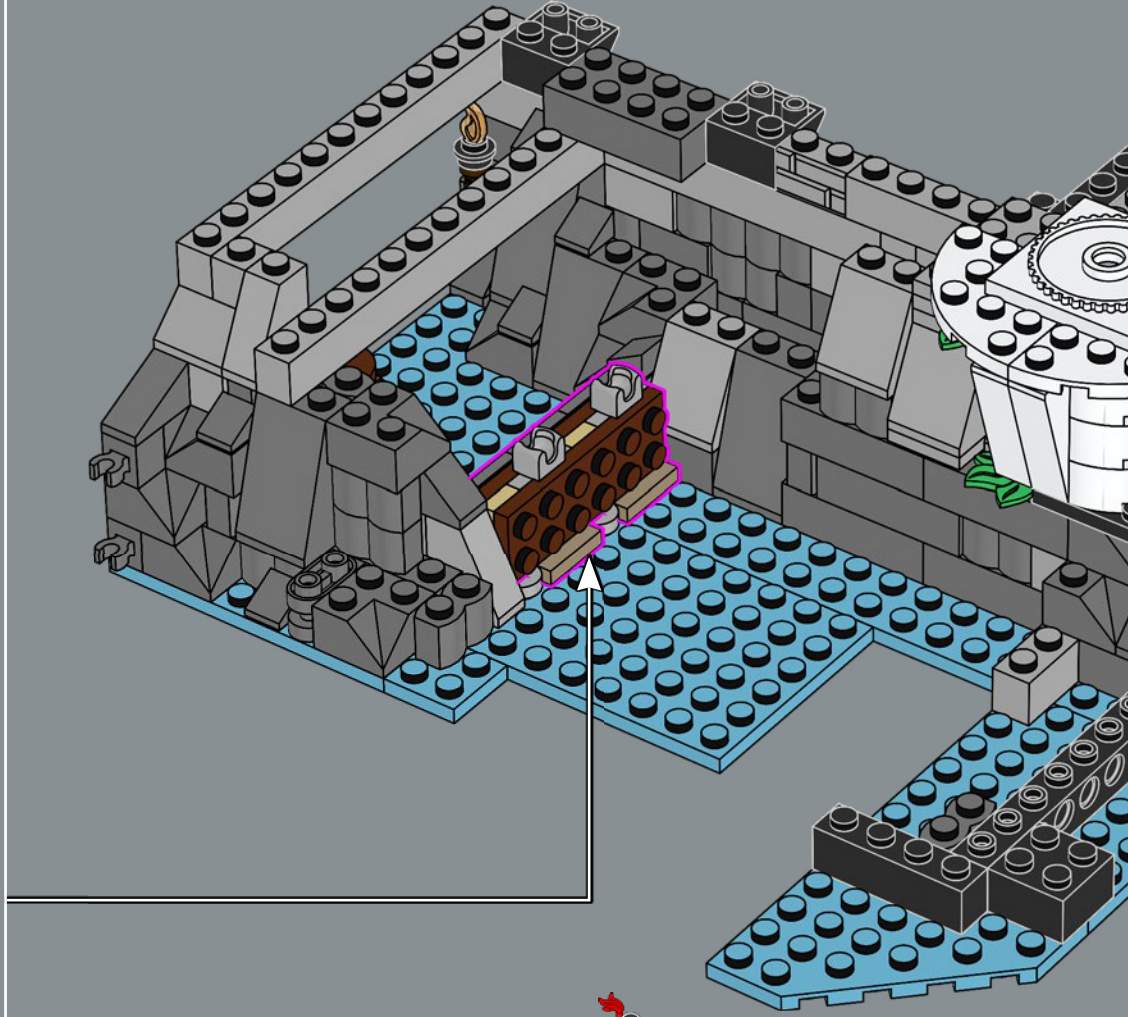
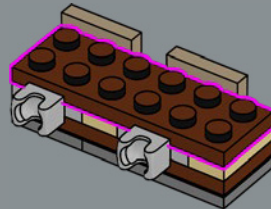



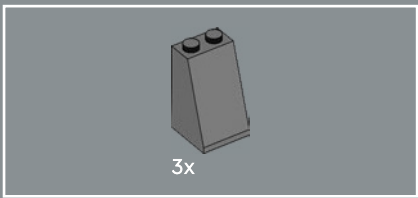

73

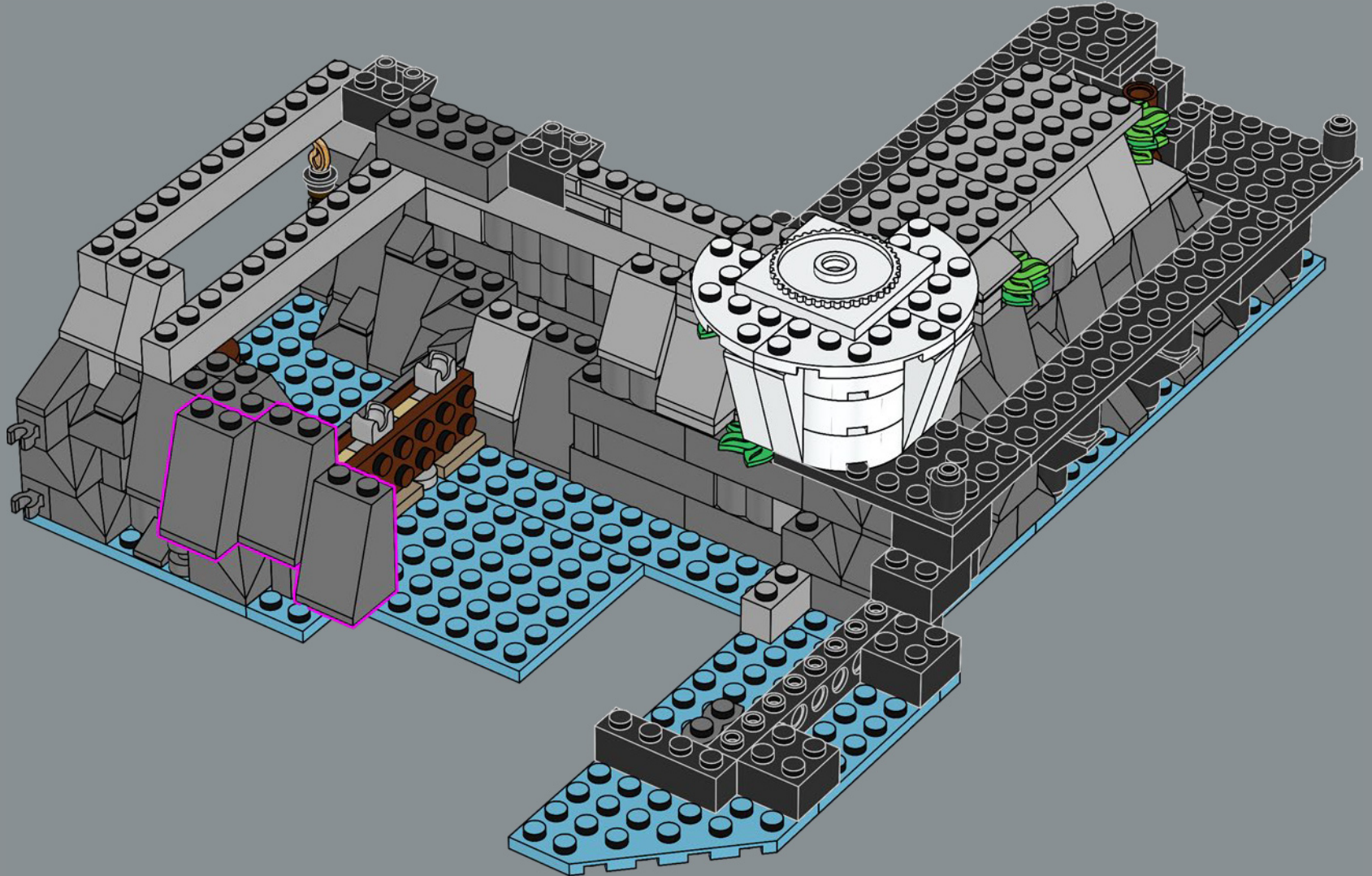

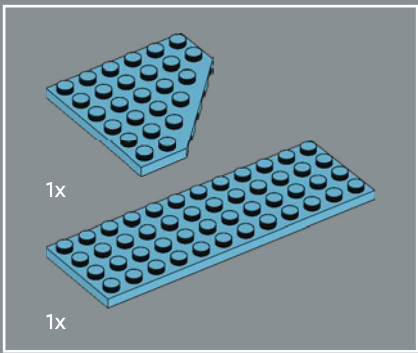

74

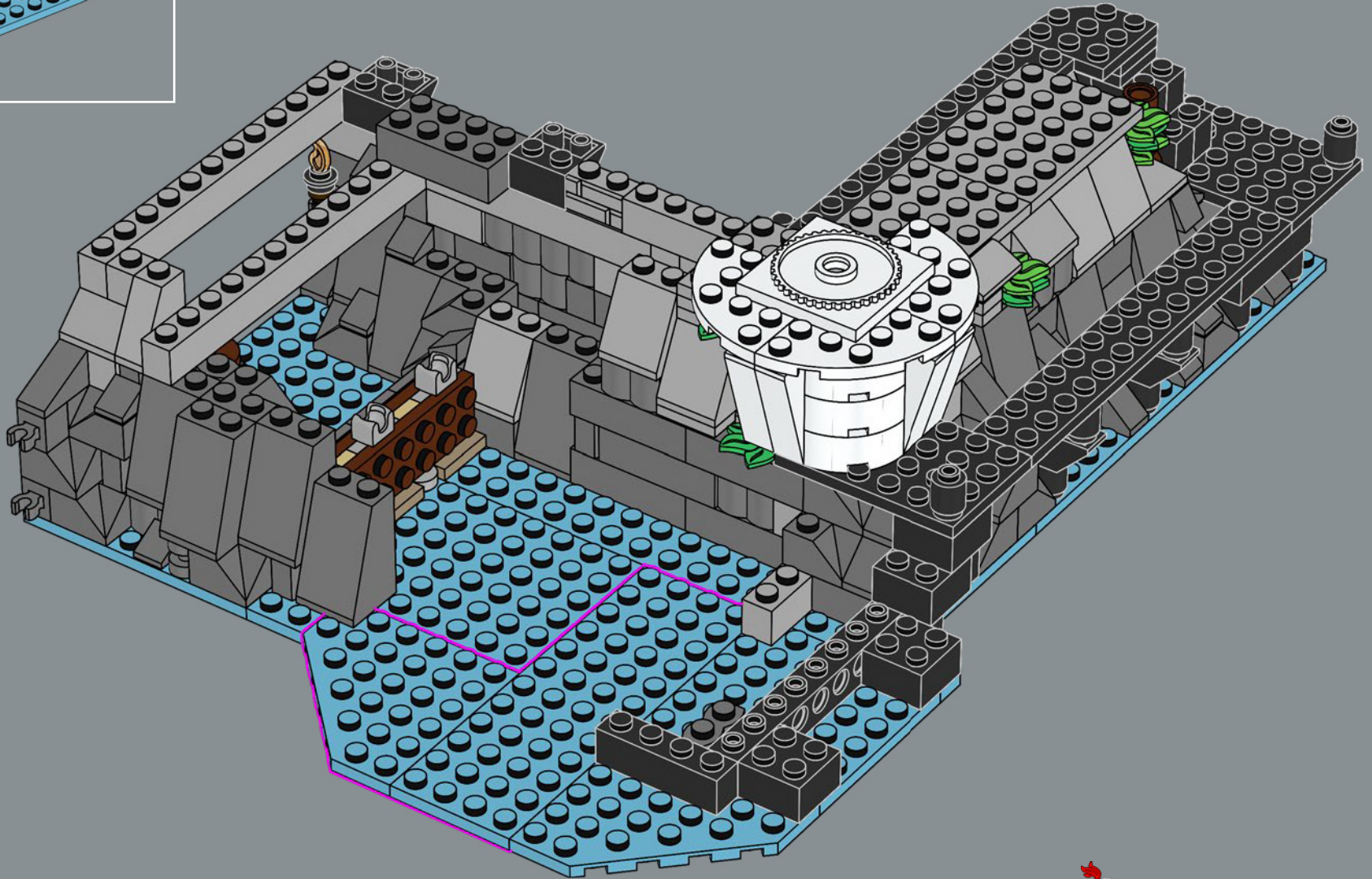



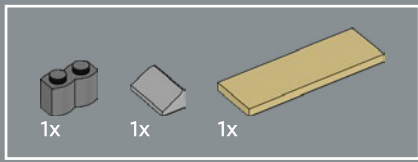

75

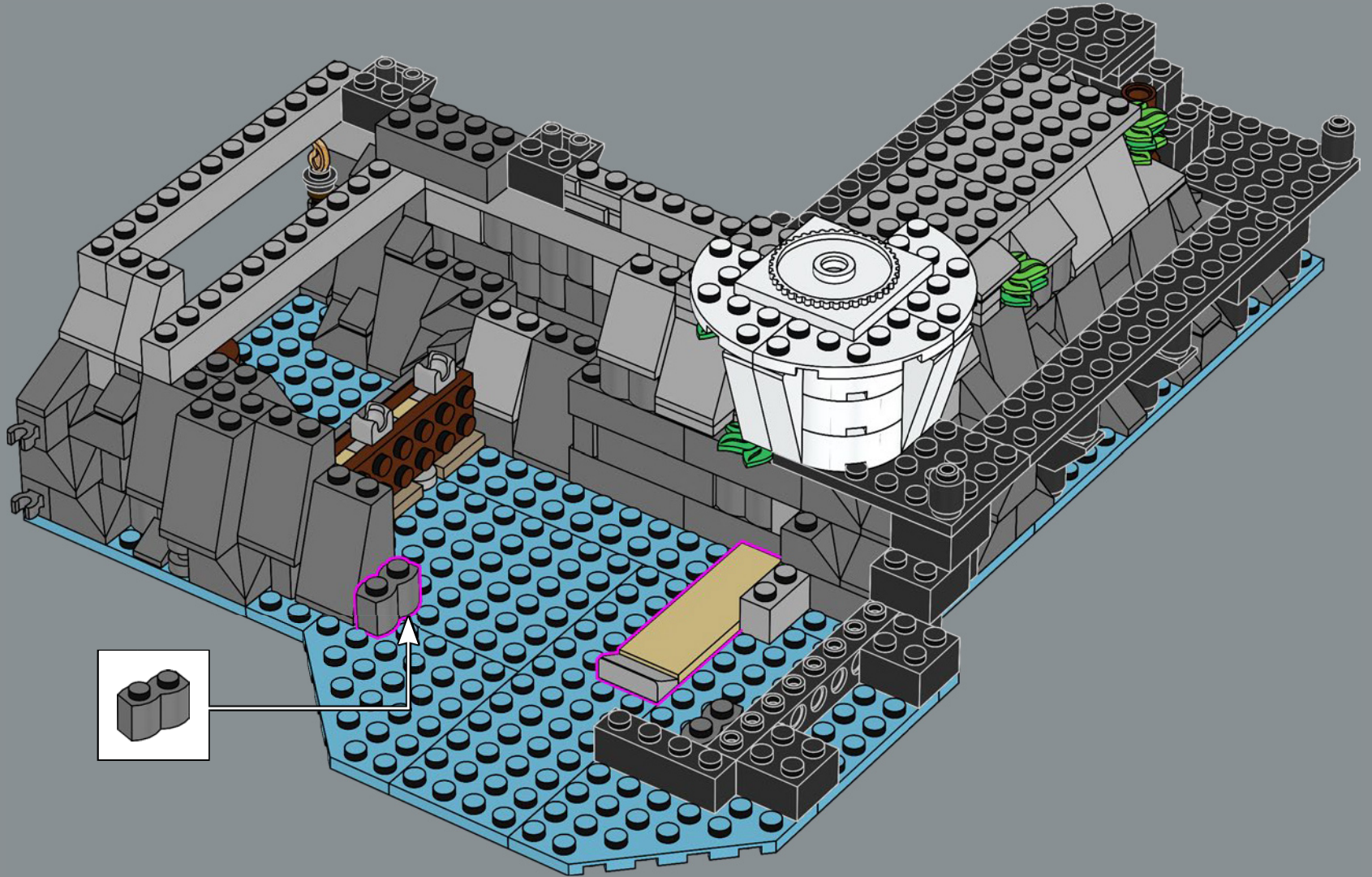

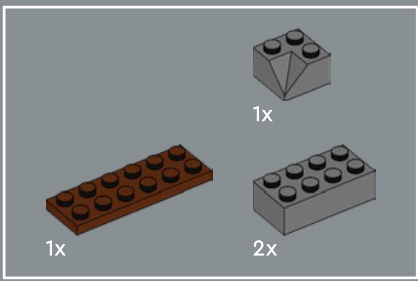

76

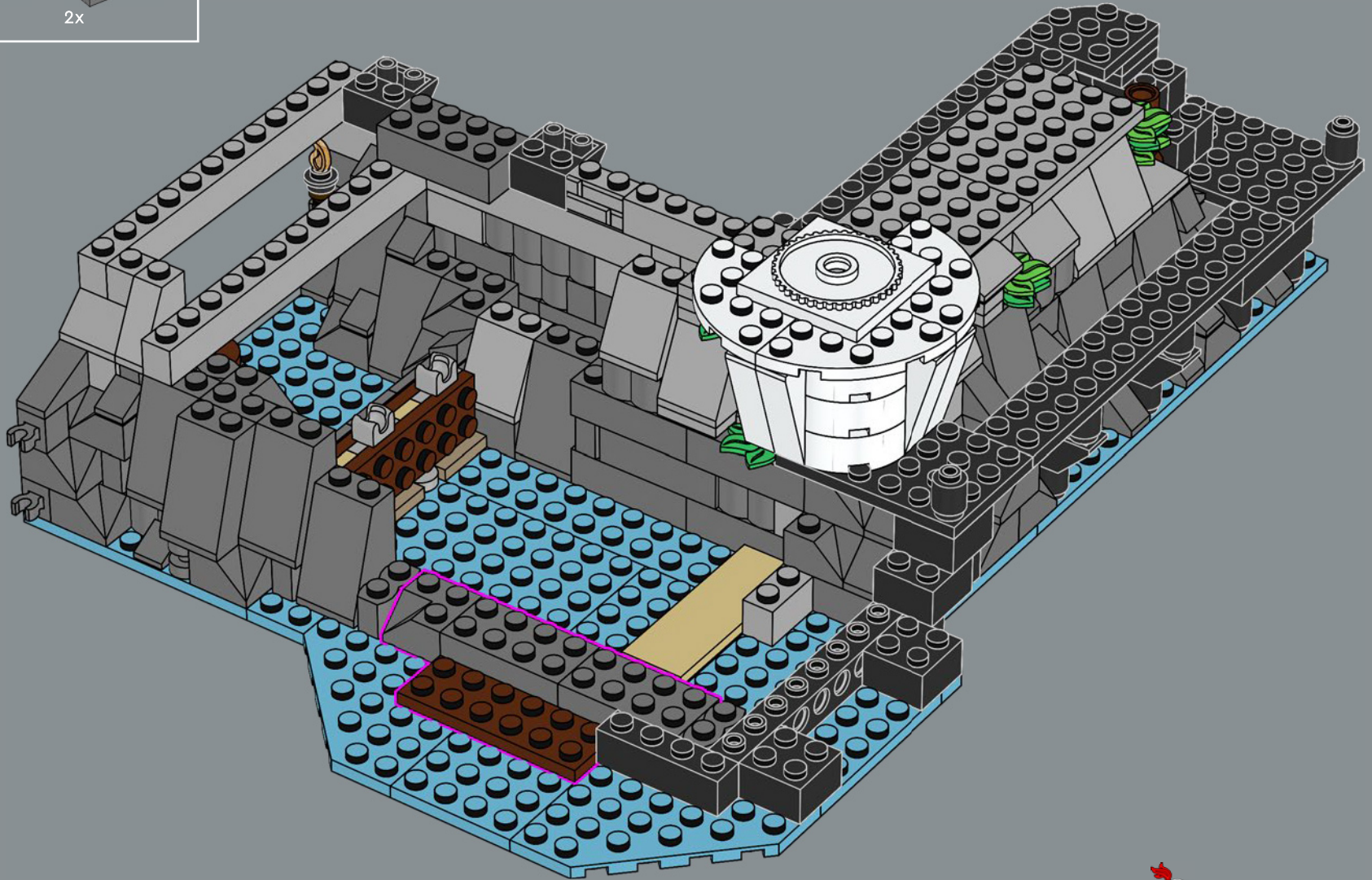



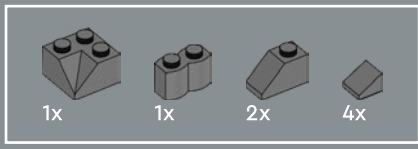

77

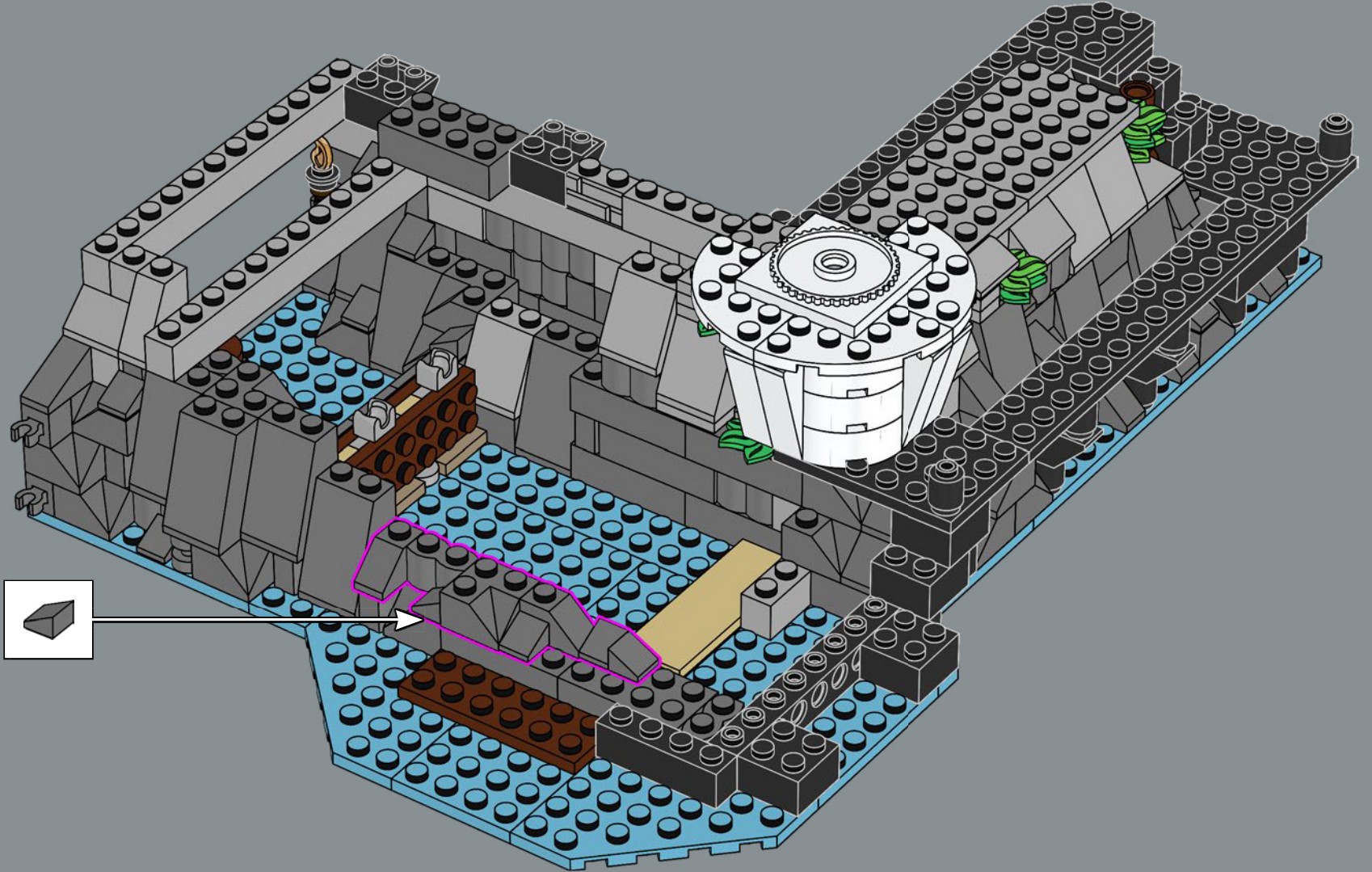



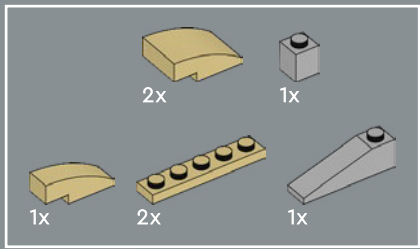

78

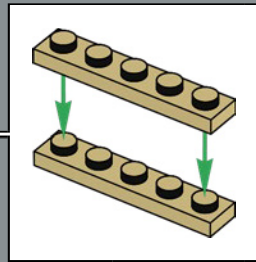
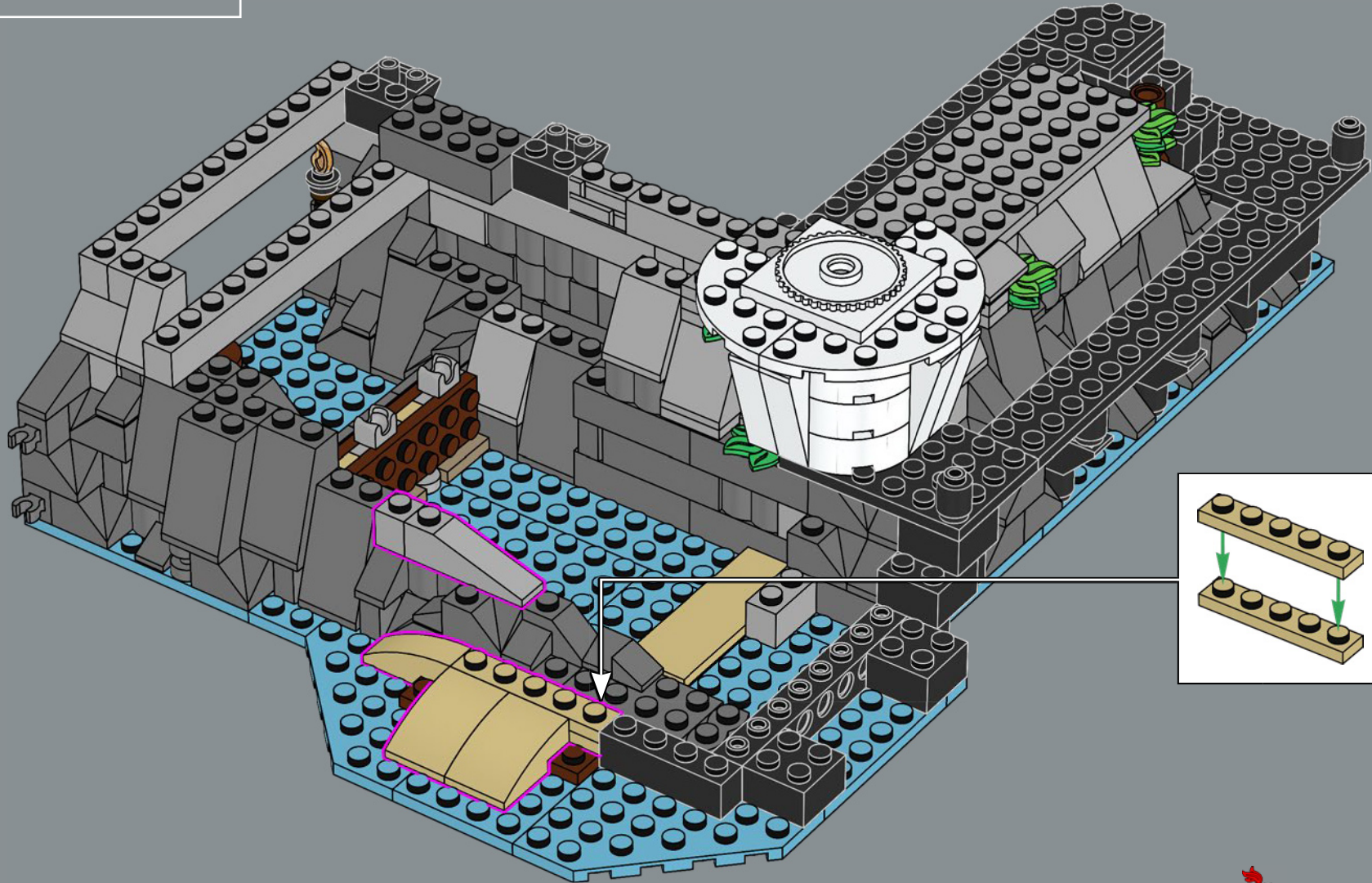

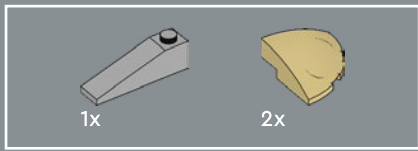

79

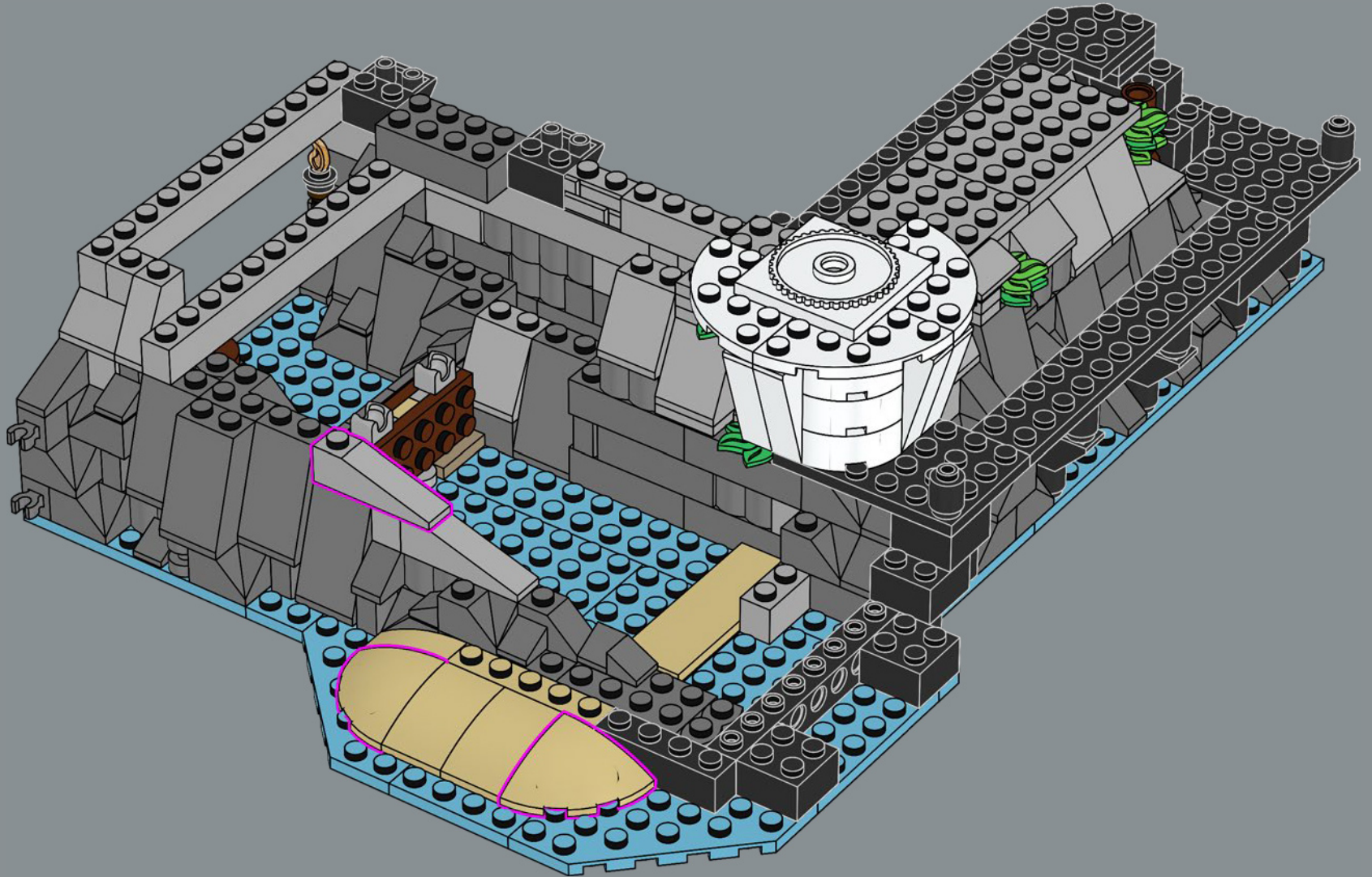



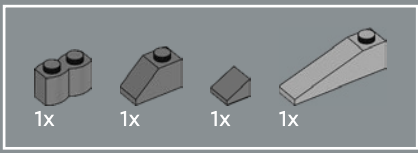

80

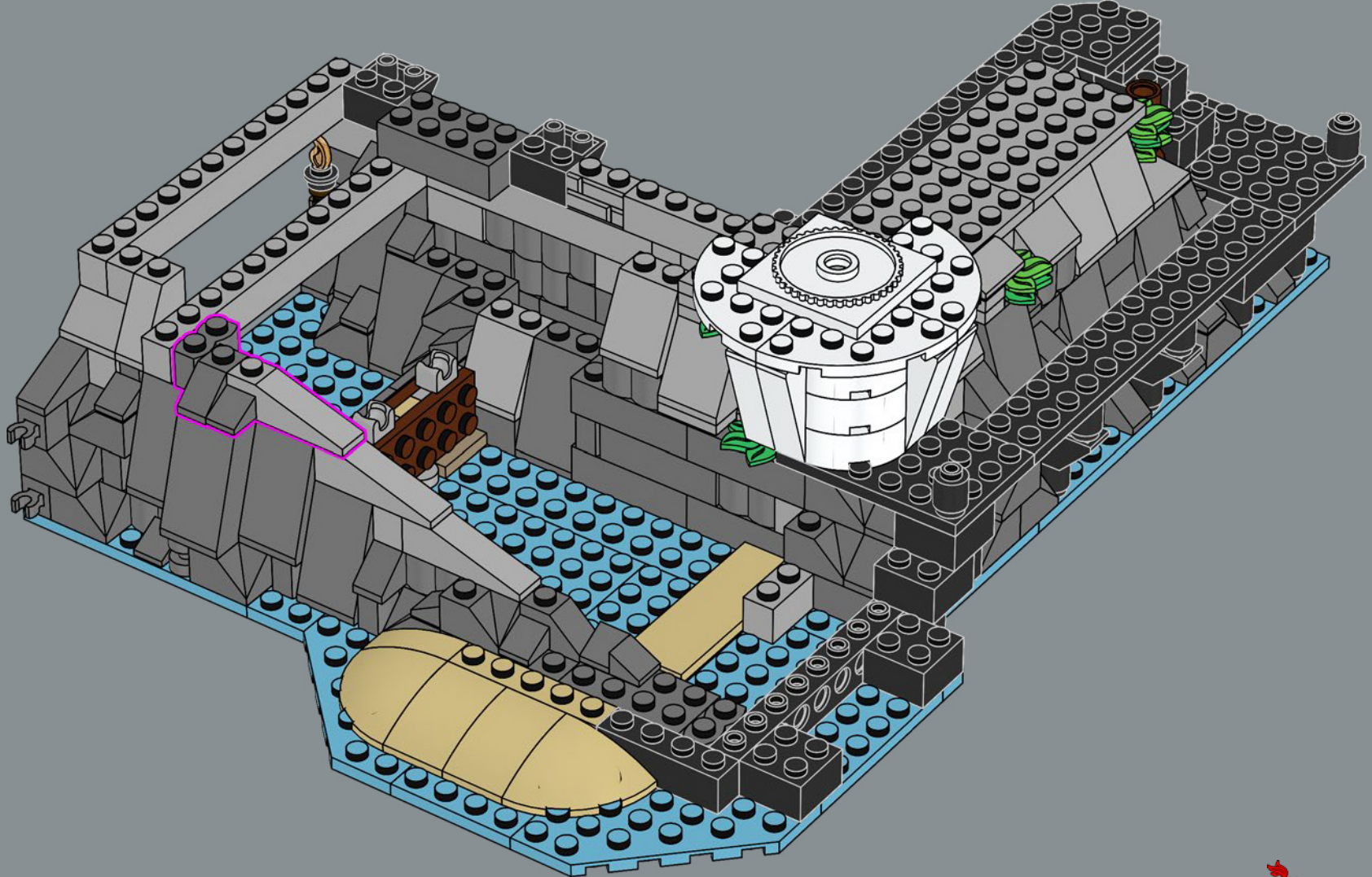



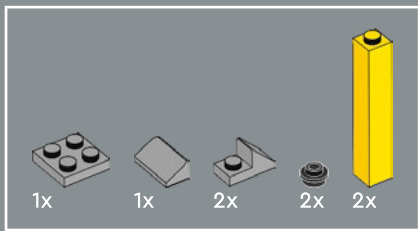

81

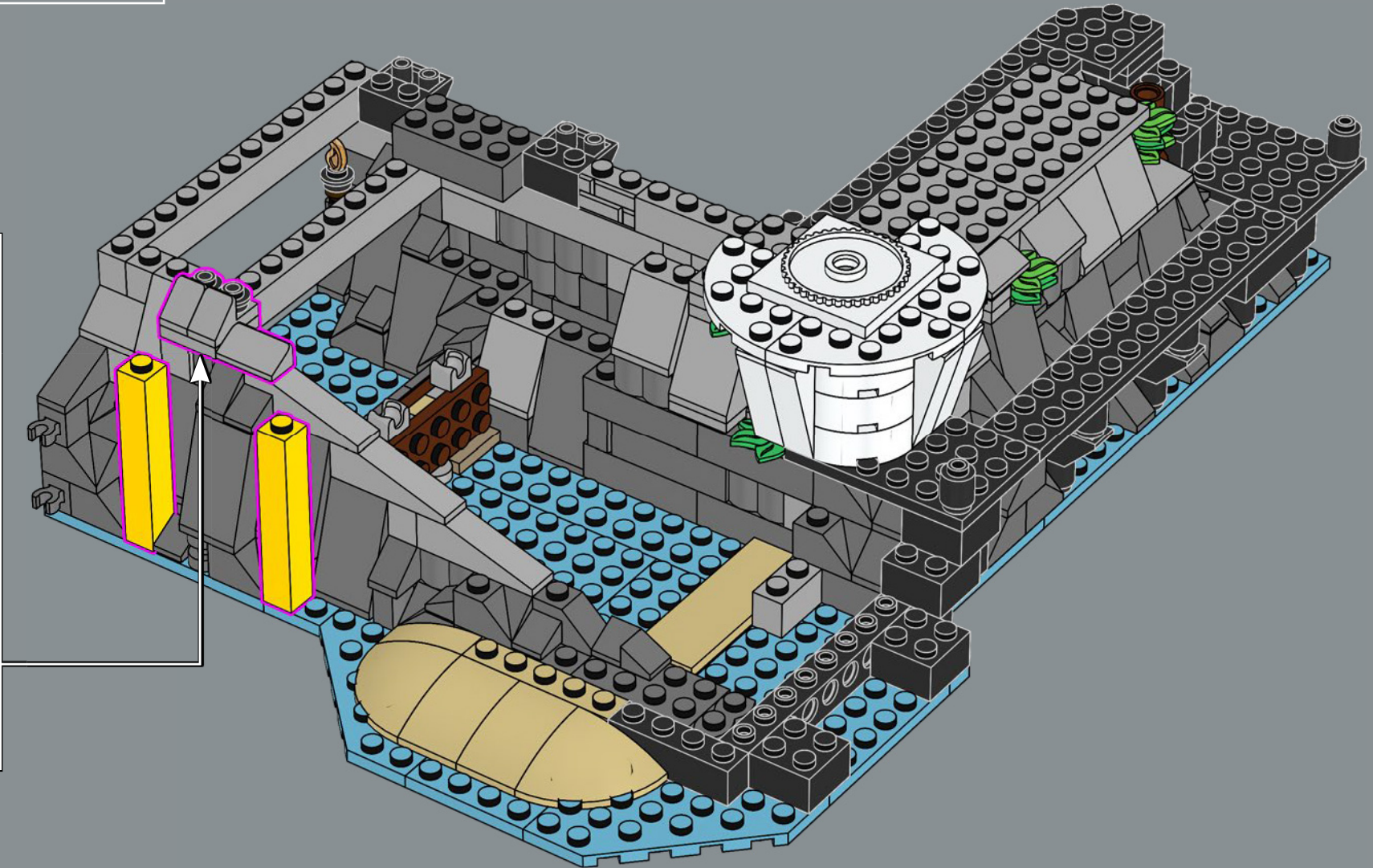
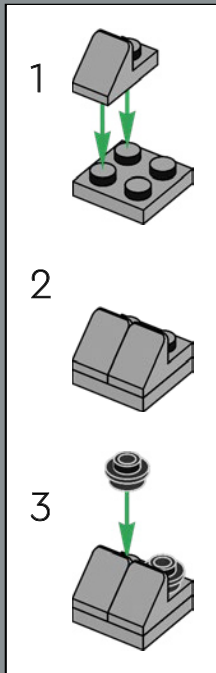

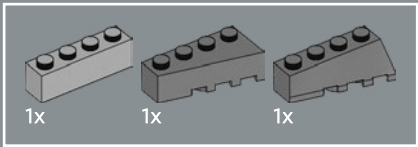

82

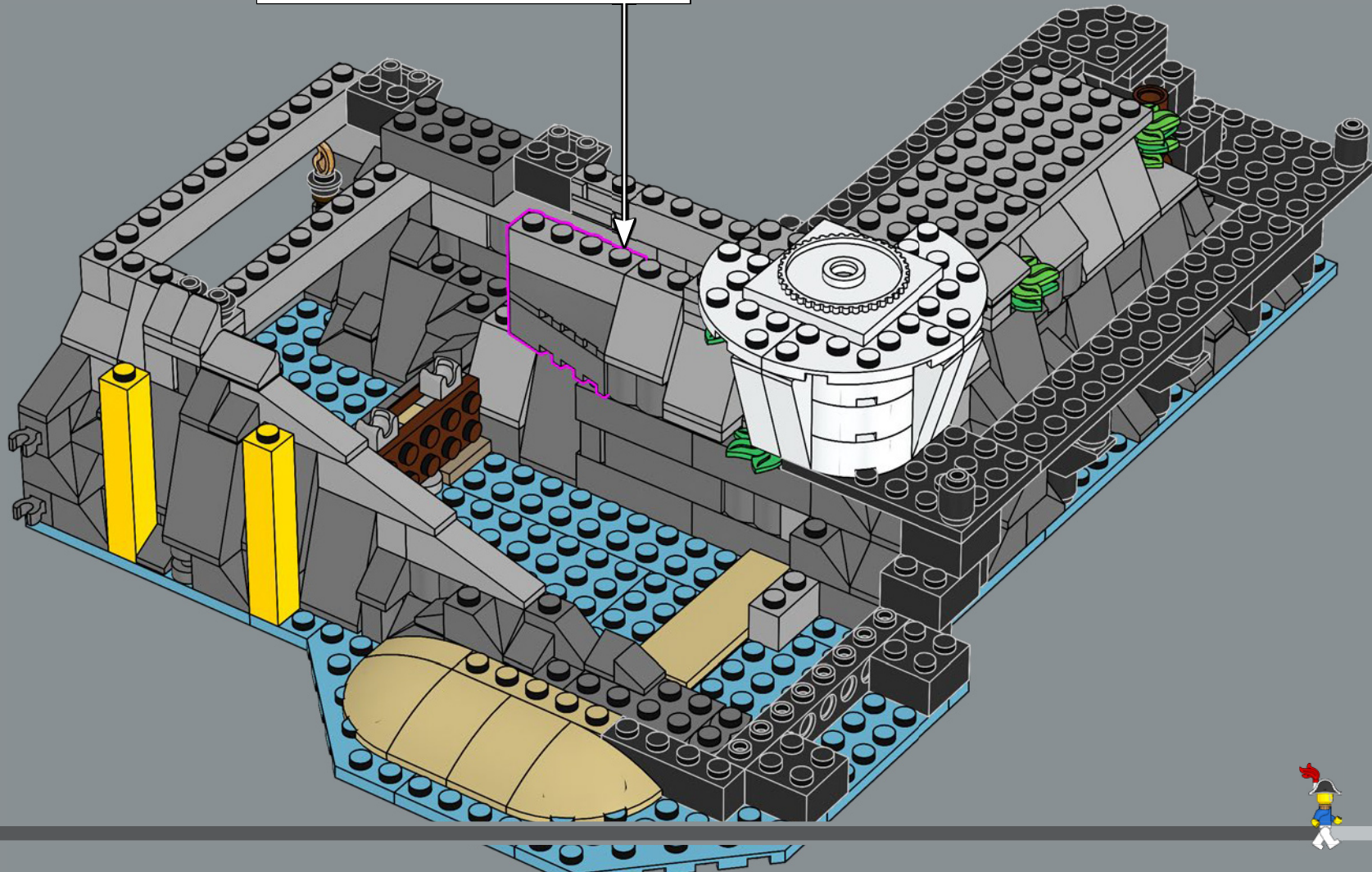
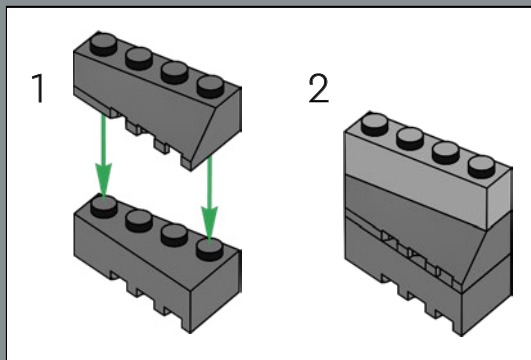



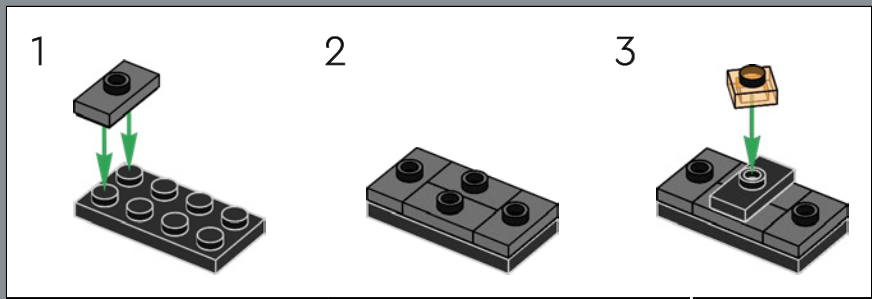
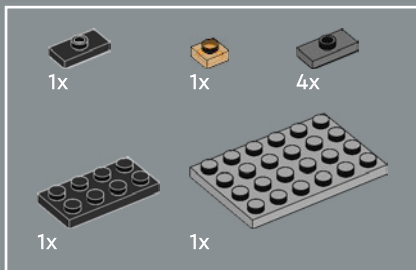

83

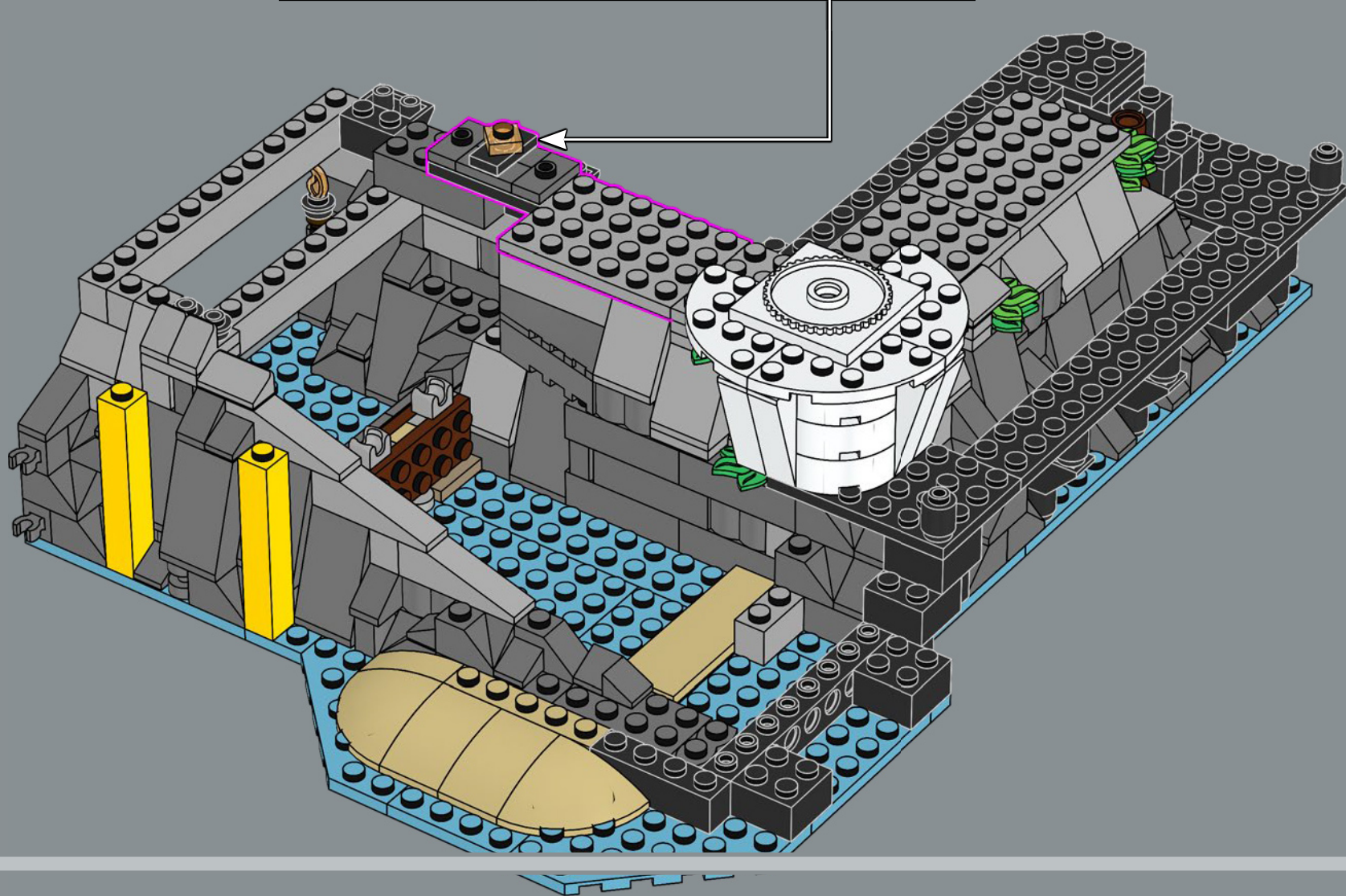



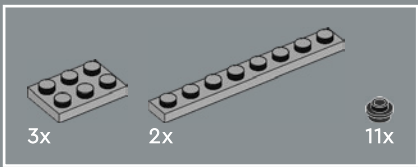

84

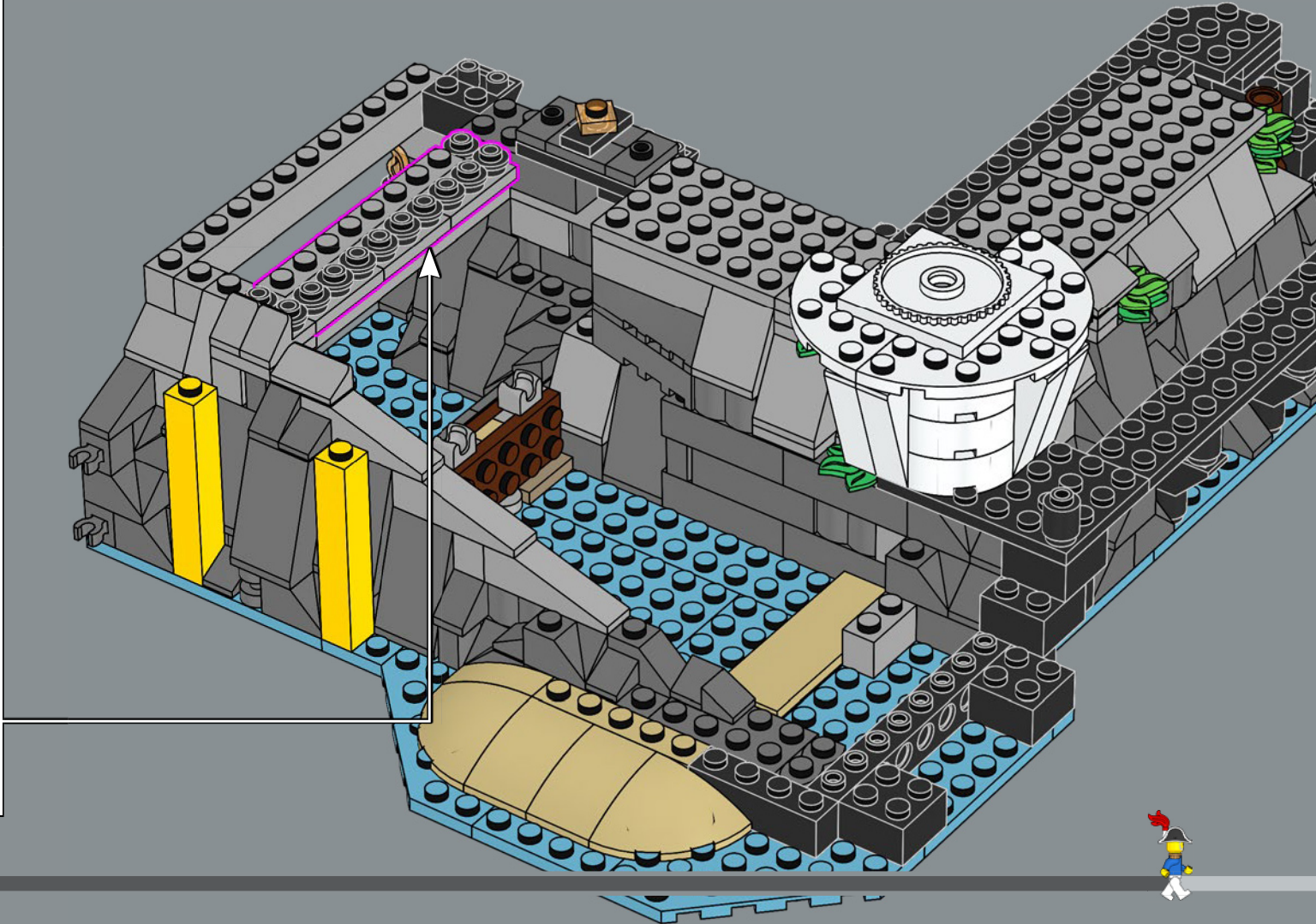
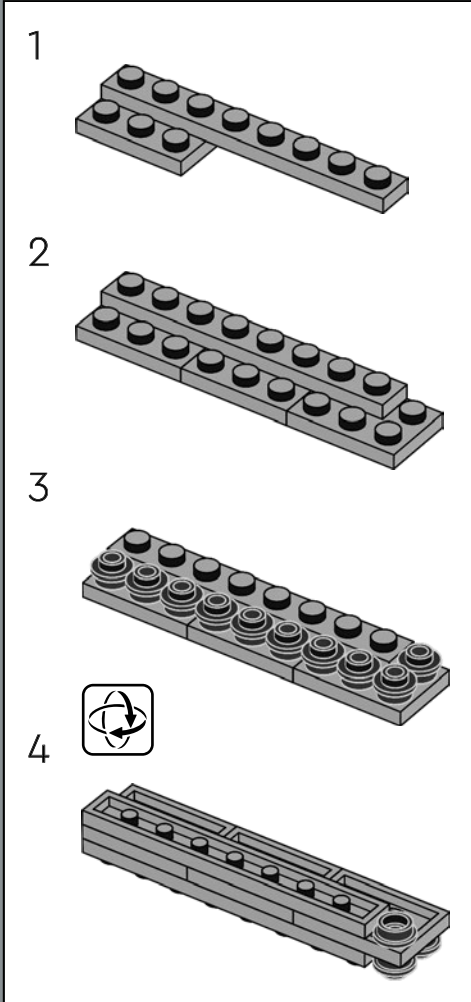

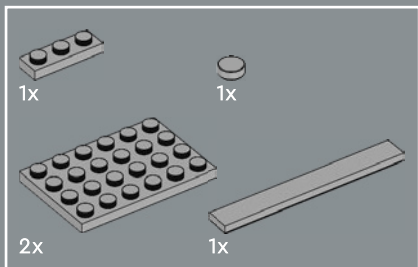

85

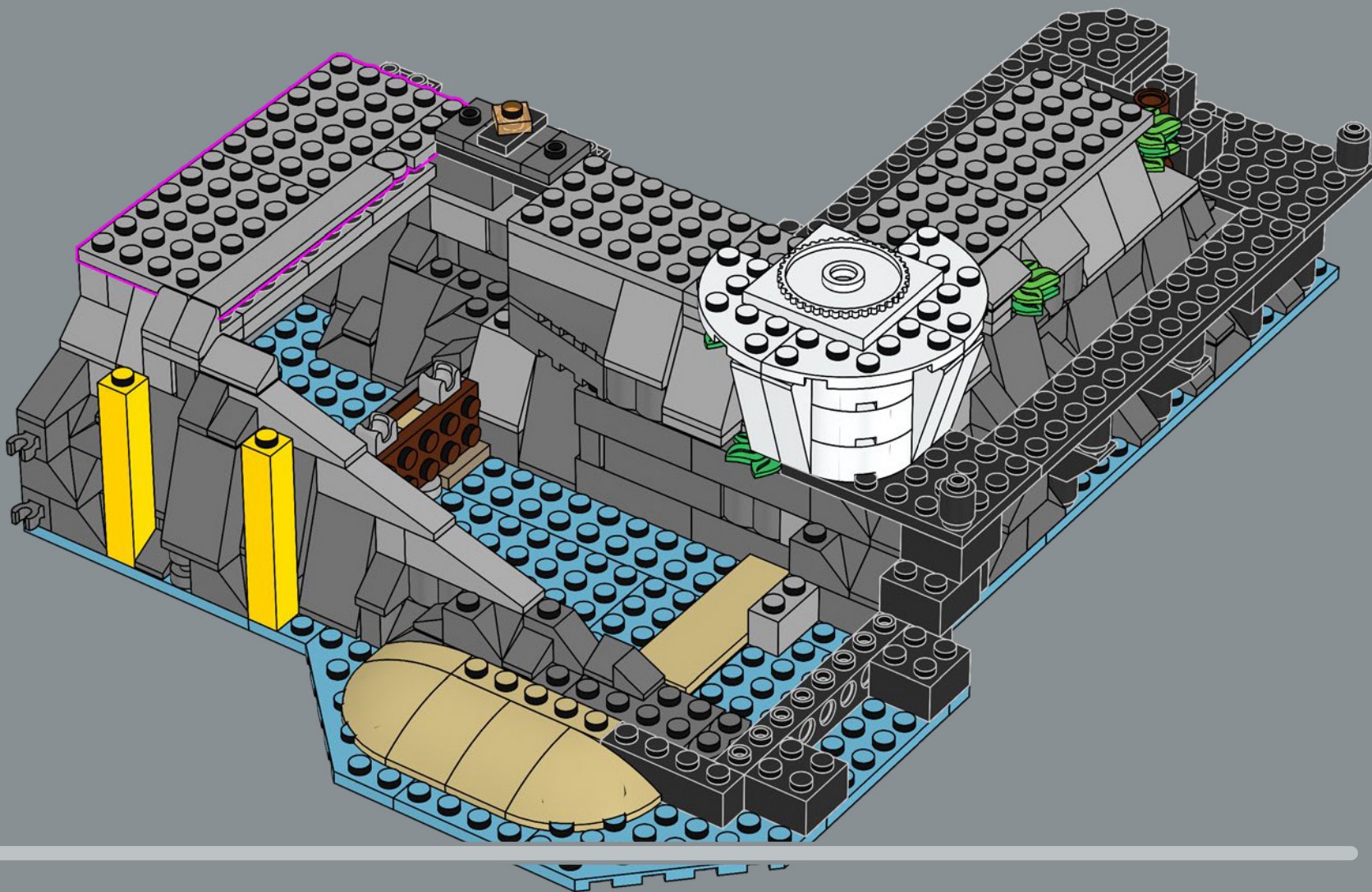



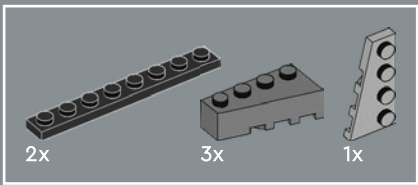

86

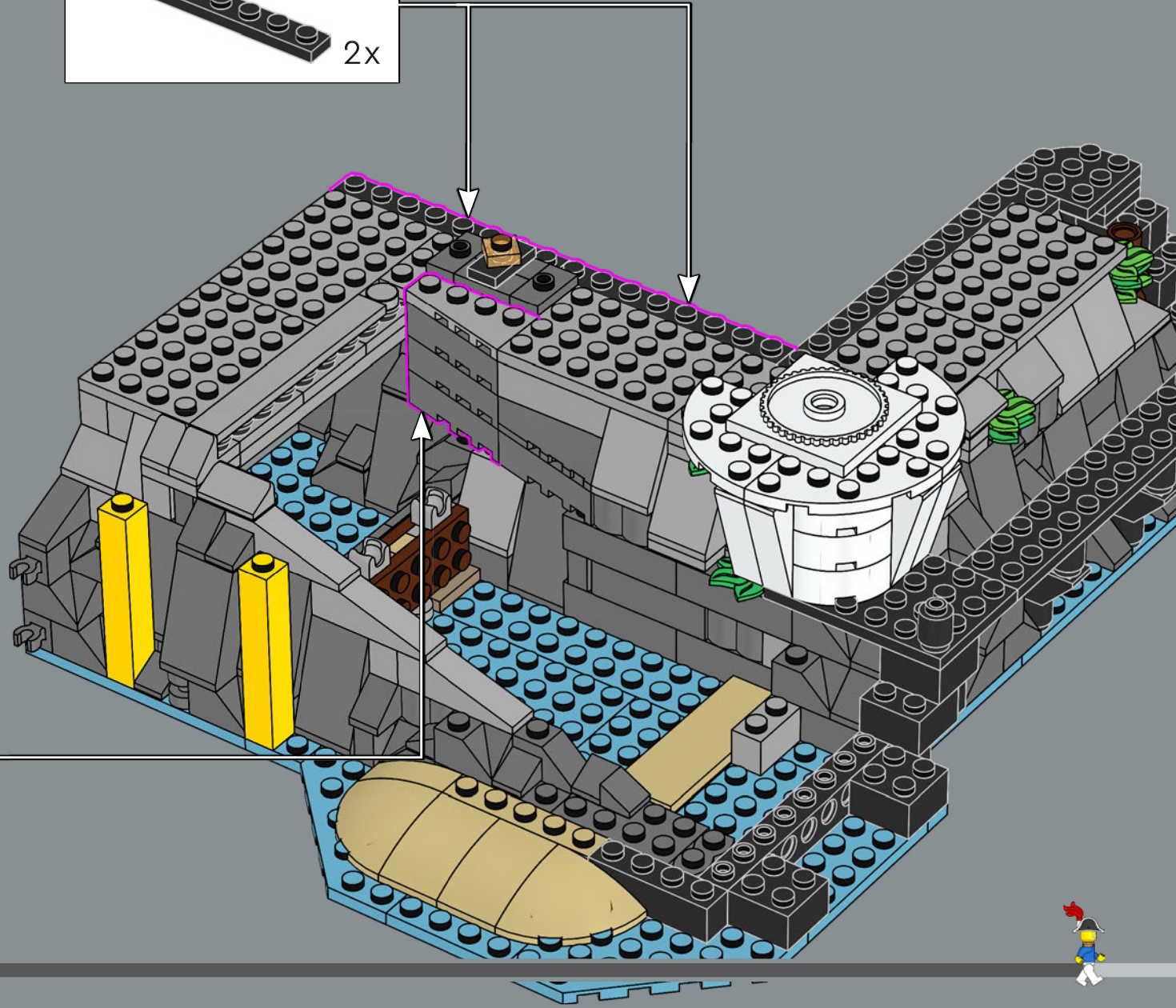
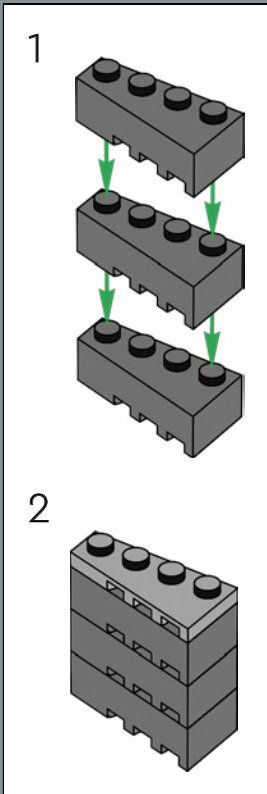
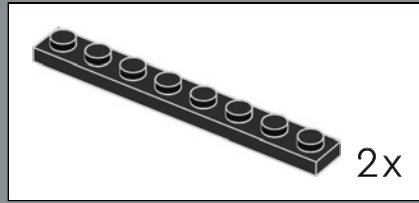



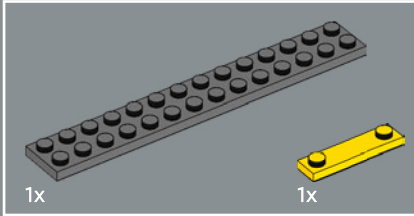
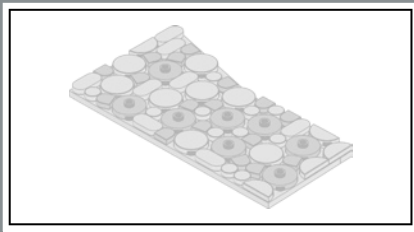

87

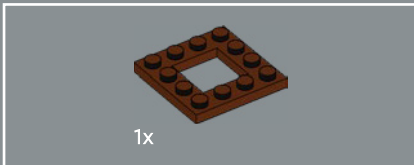
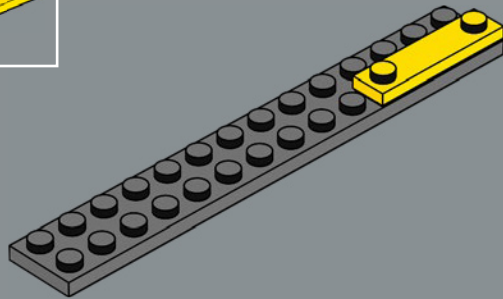

88

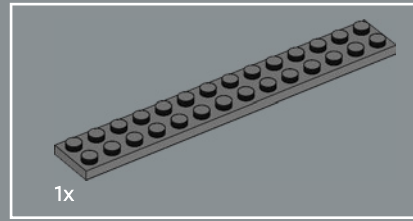
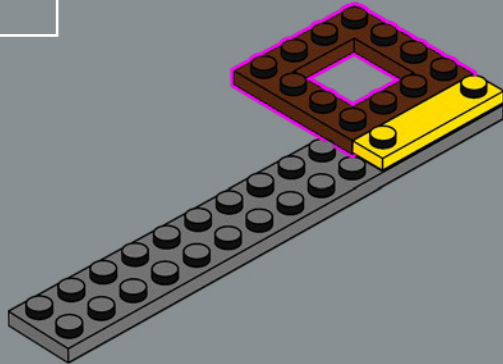

89

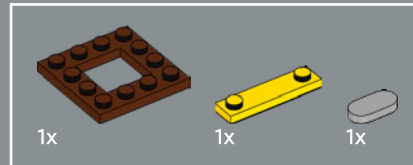
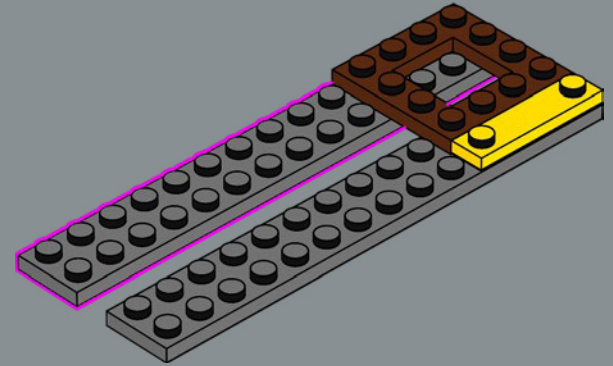

90

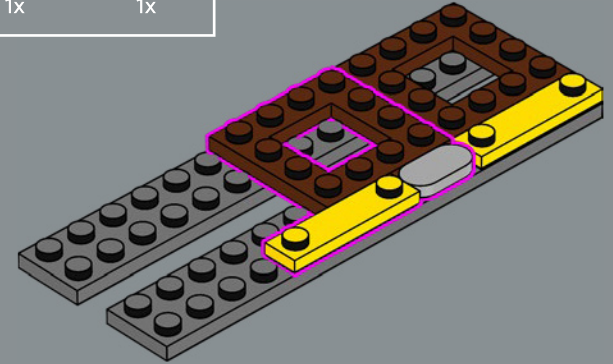

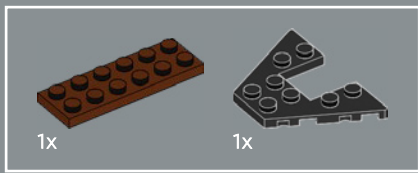

91

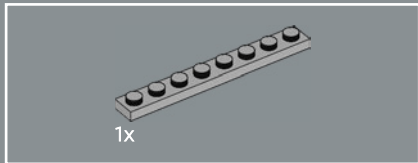
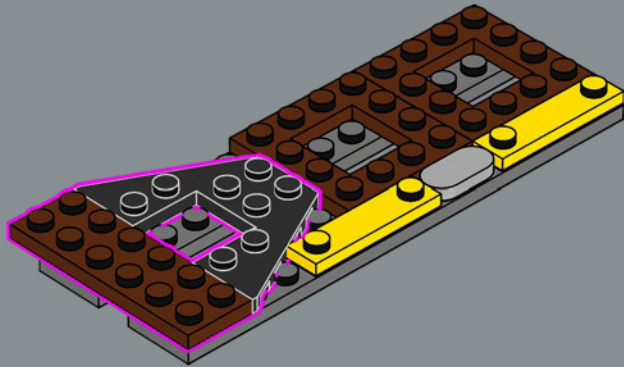

92

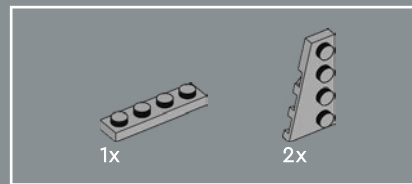
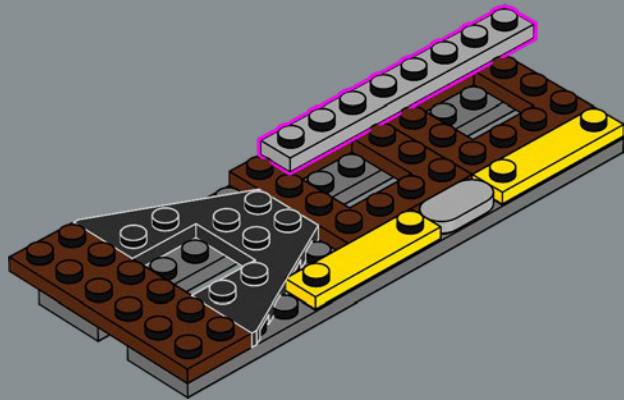

93

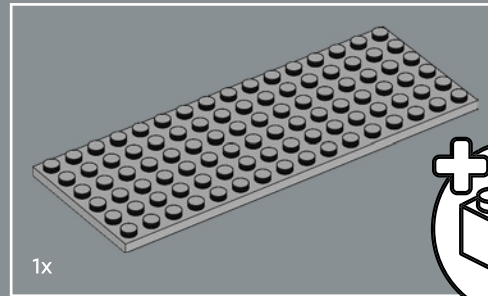
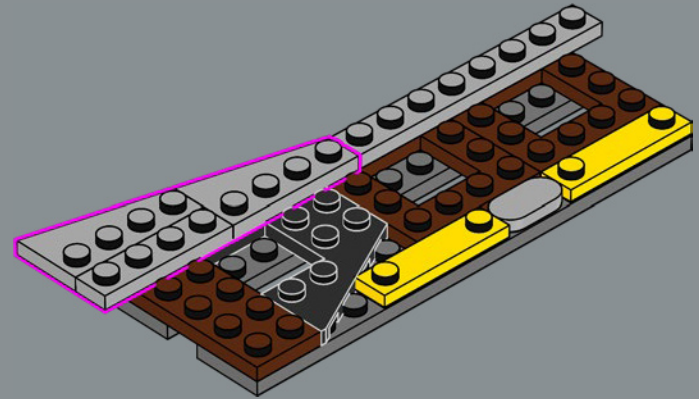

94

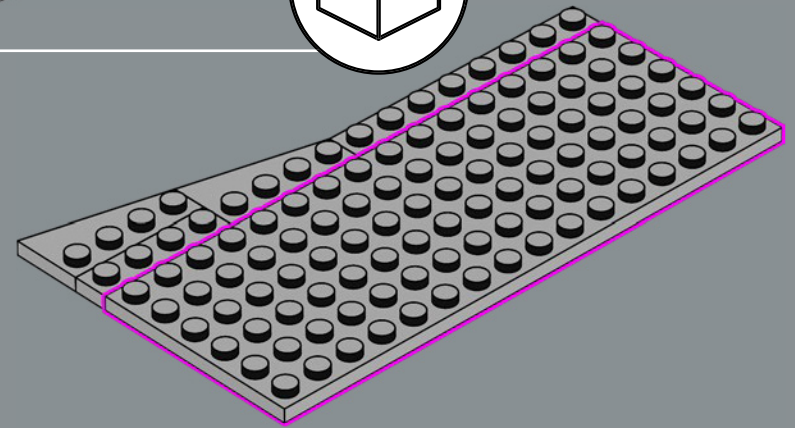

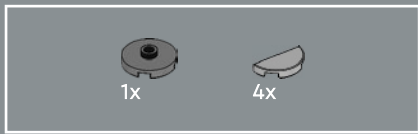

95

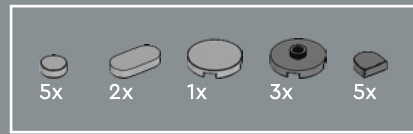
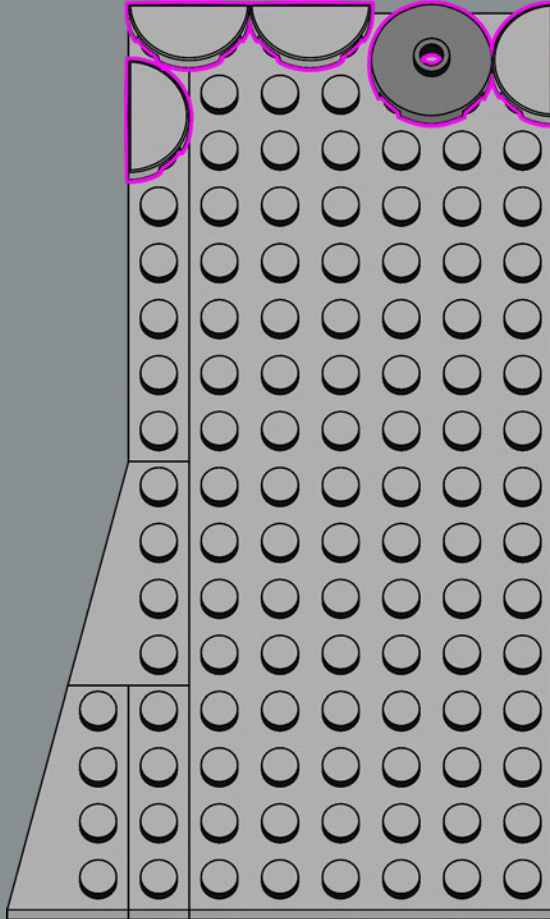

96

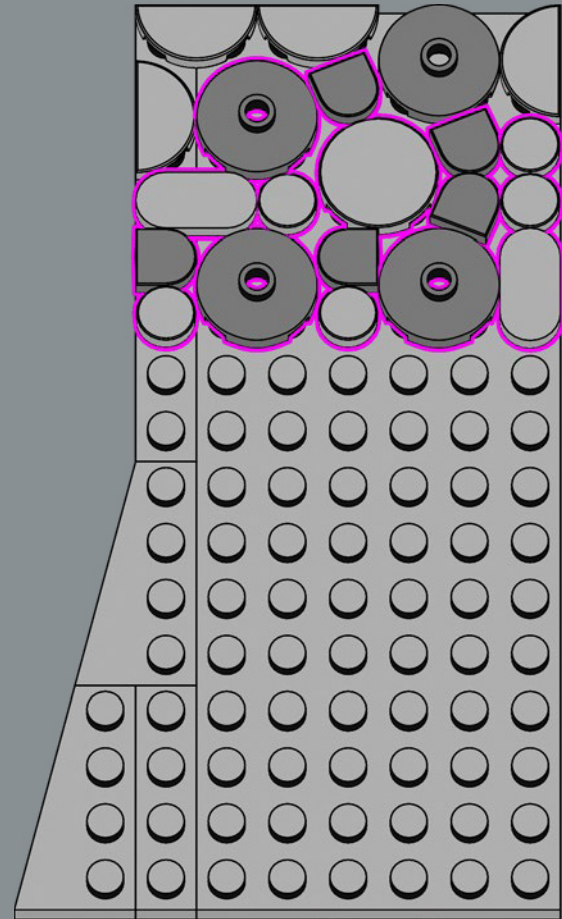



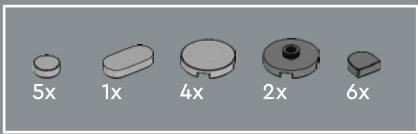

97

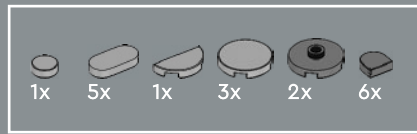
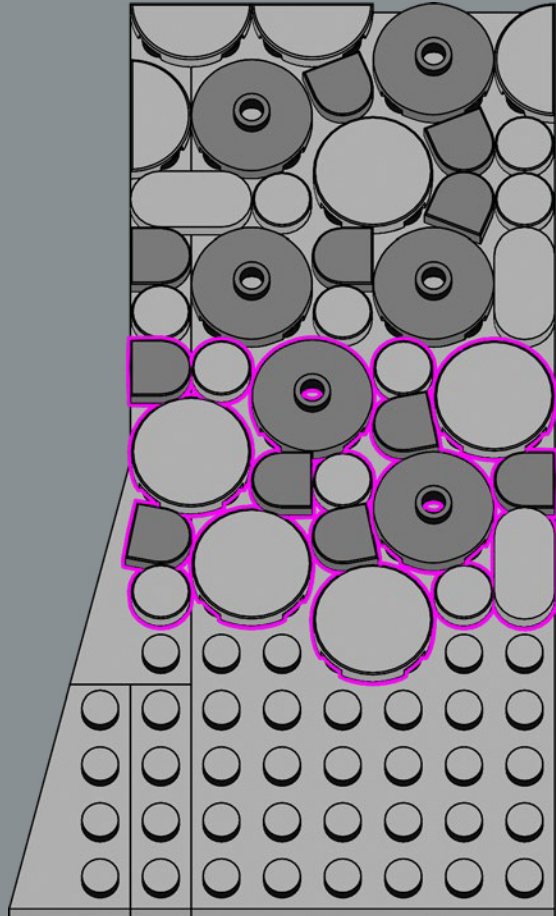

98

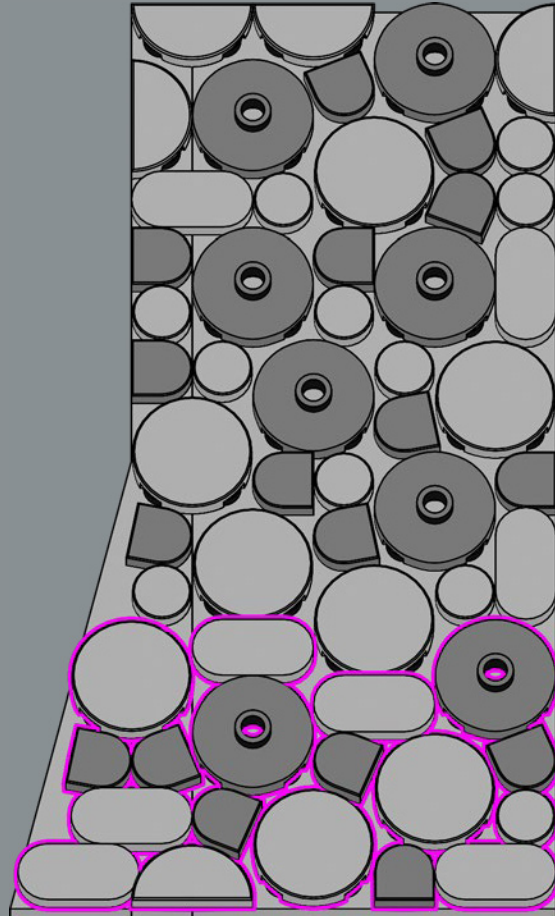

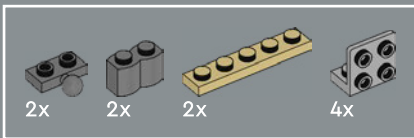

99

1

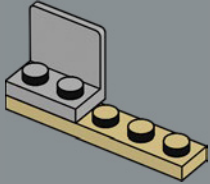

2

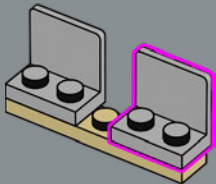

3

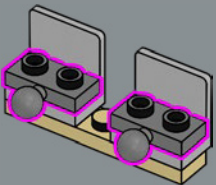

4

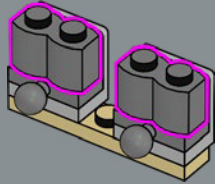

5

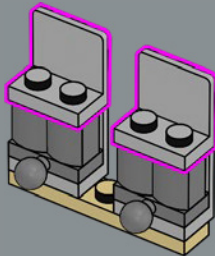

6

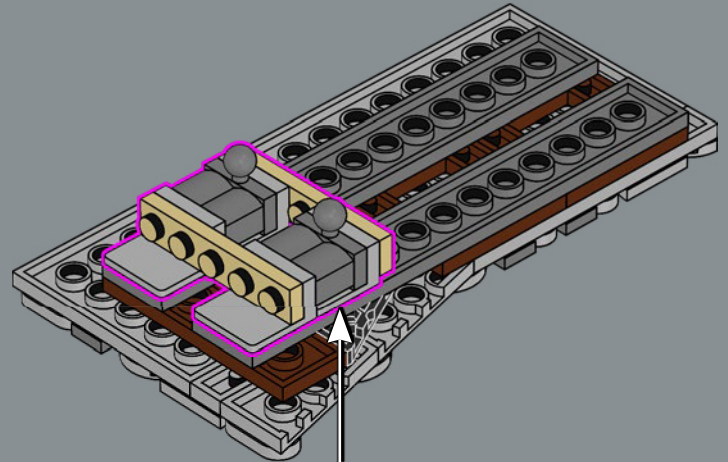
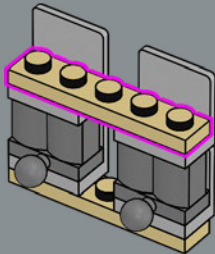



Die ursprünglich bedruckte Auffahrt wurde mit Kopfsteinen neu gepflastert.

100

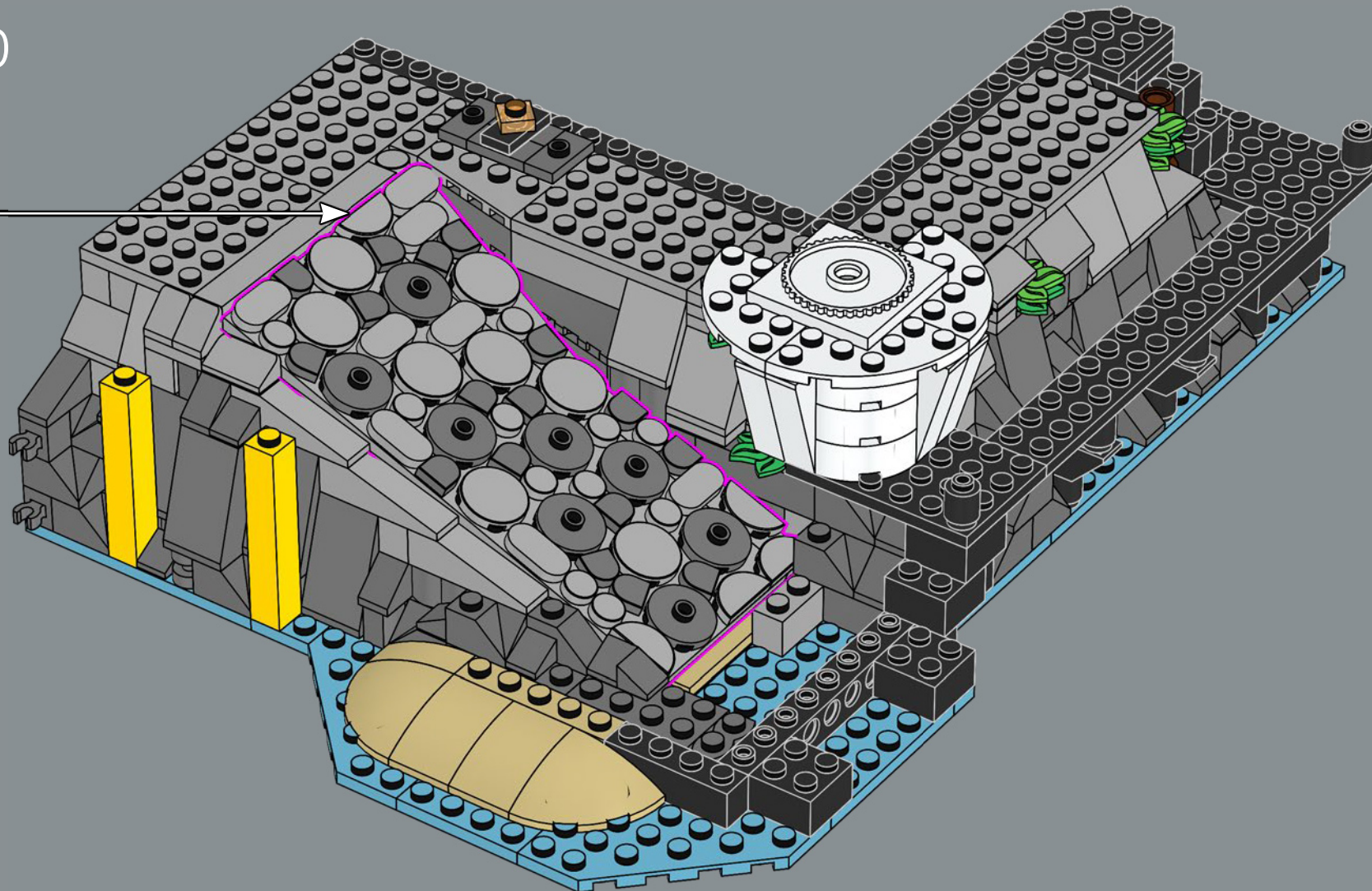
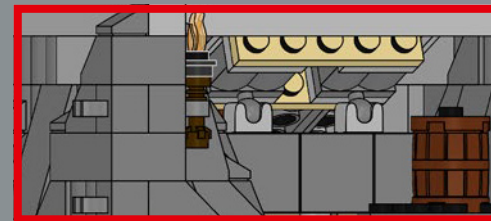



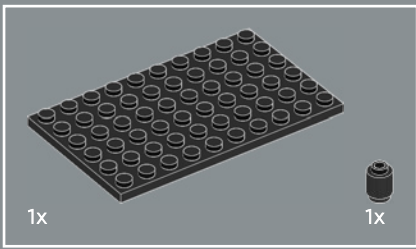

101

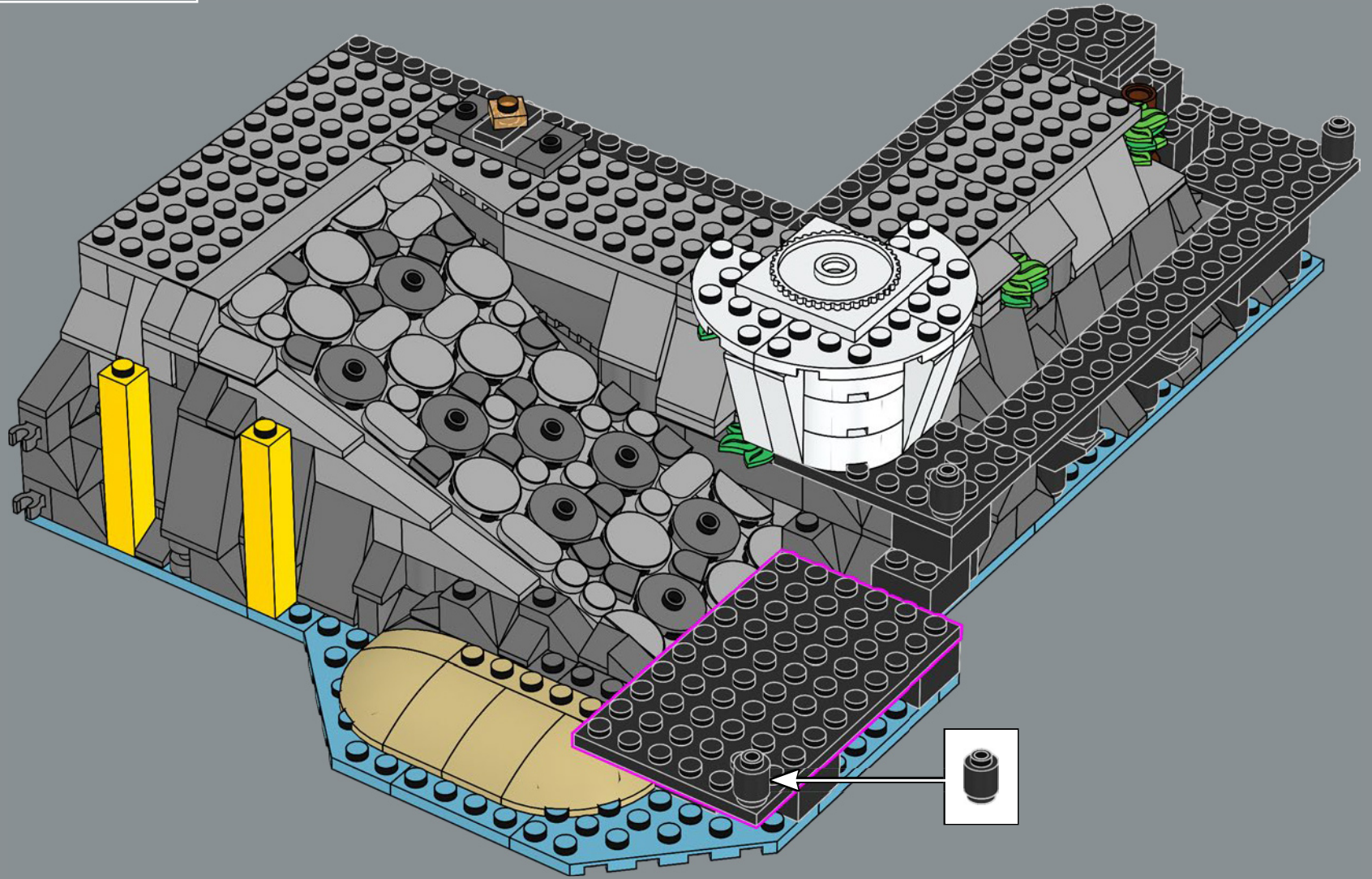

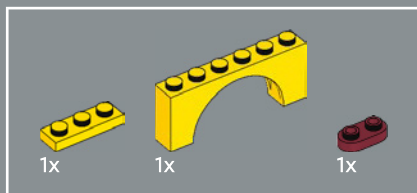

102

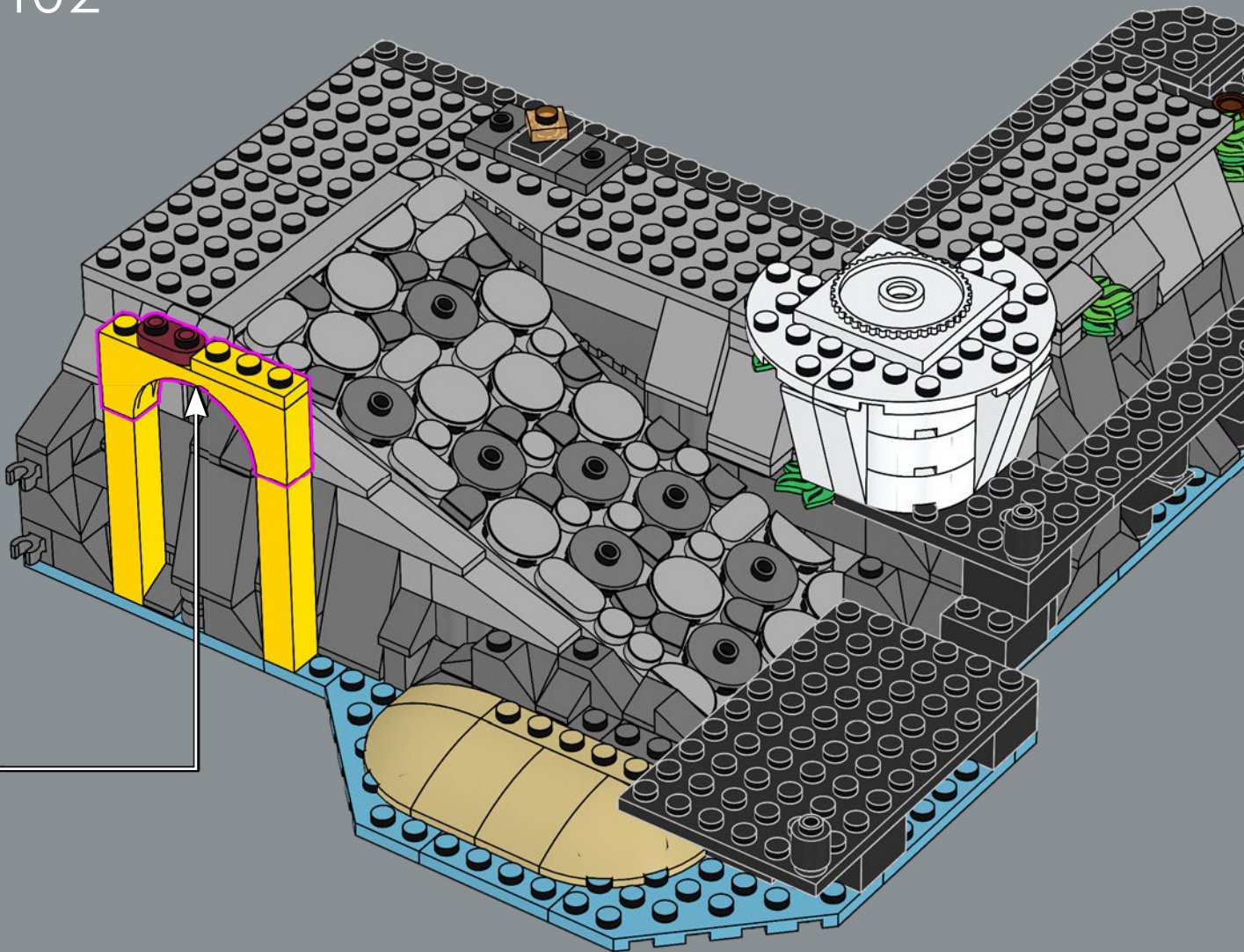
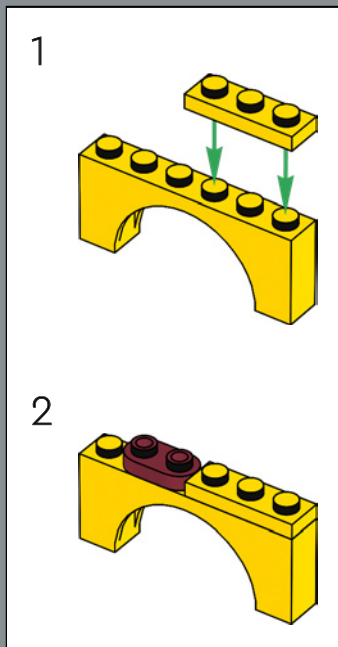



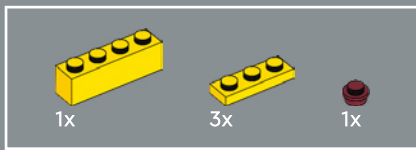

103

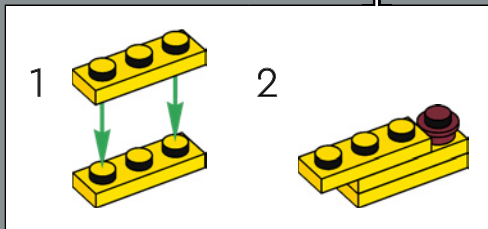
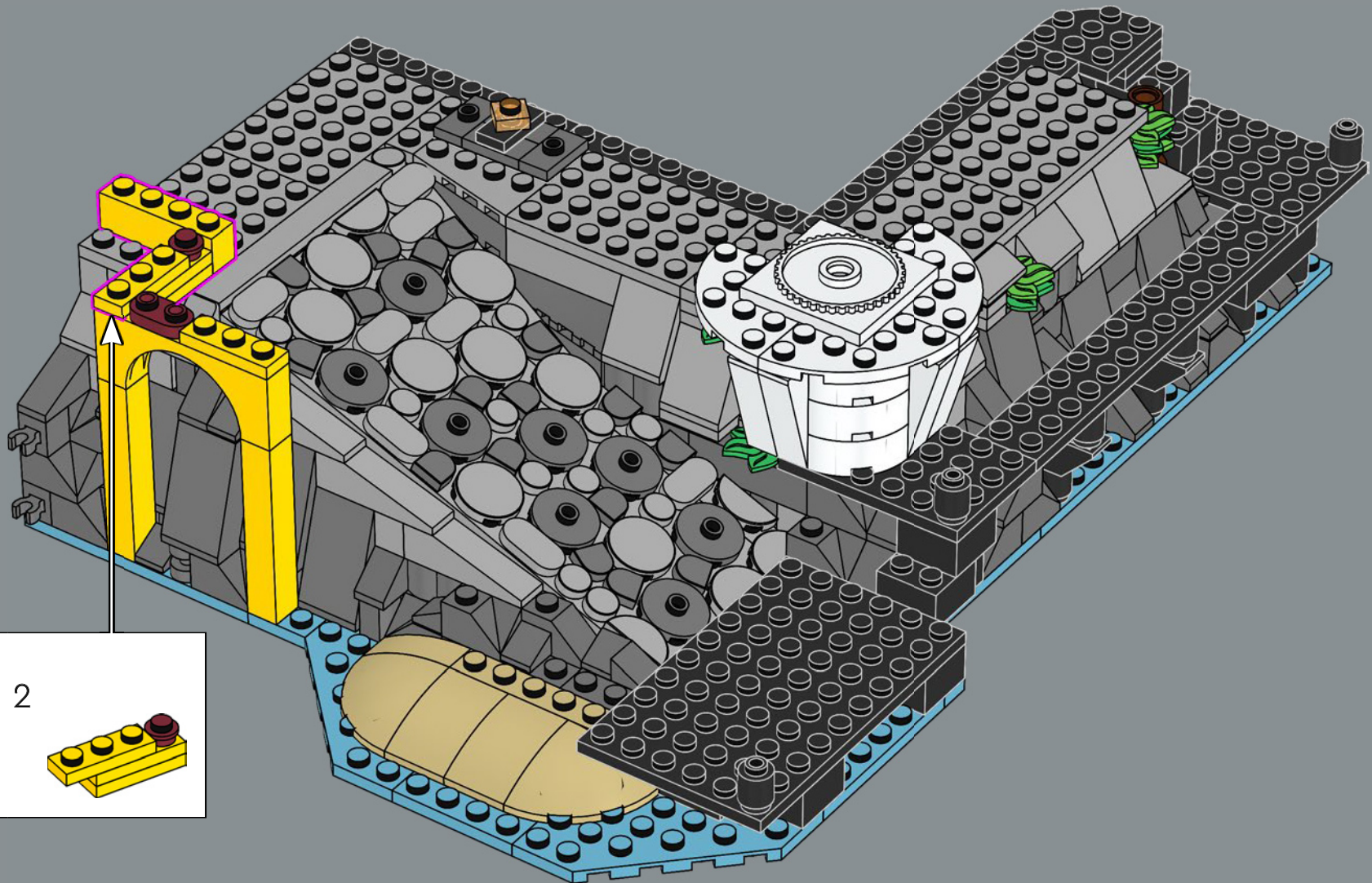



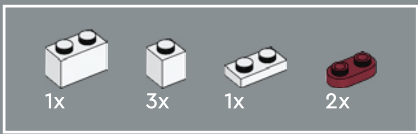

104

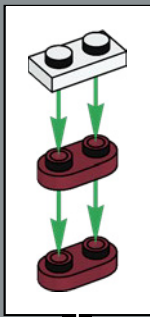

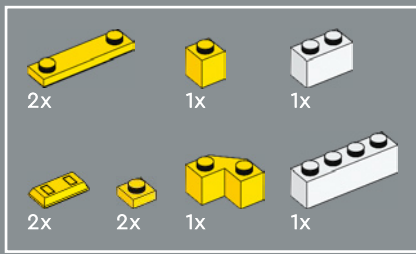

105

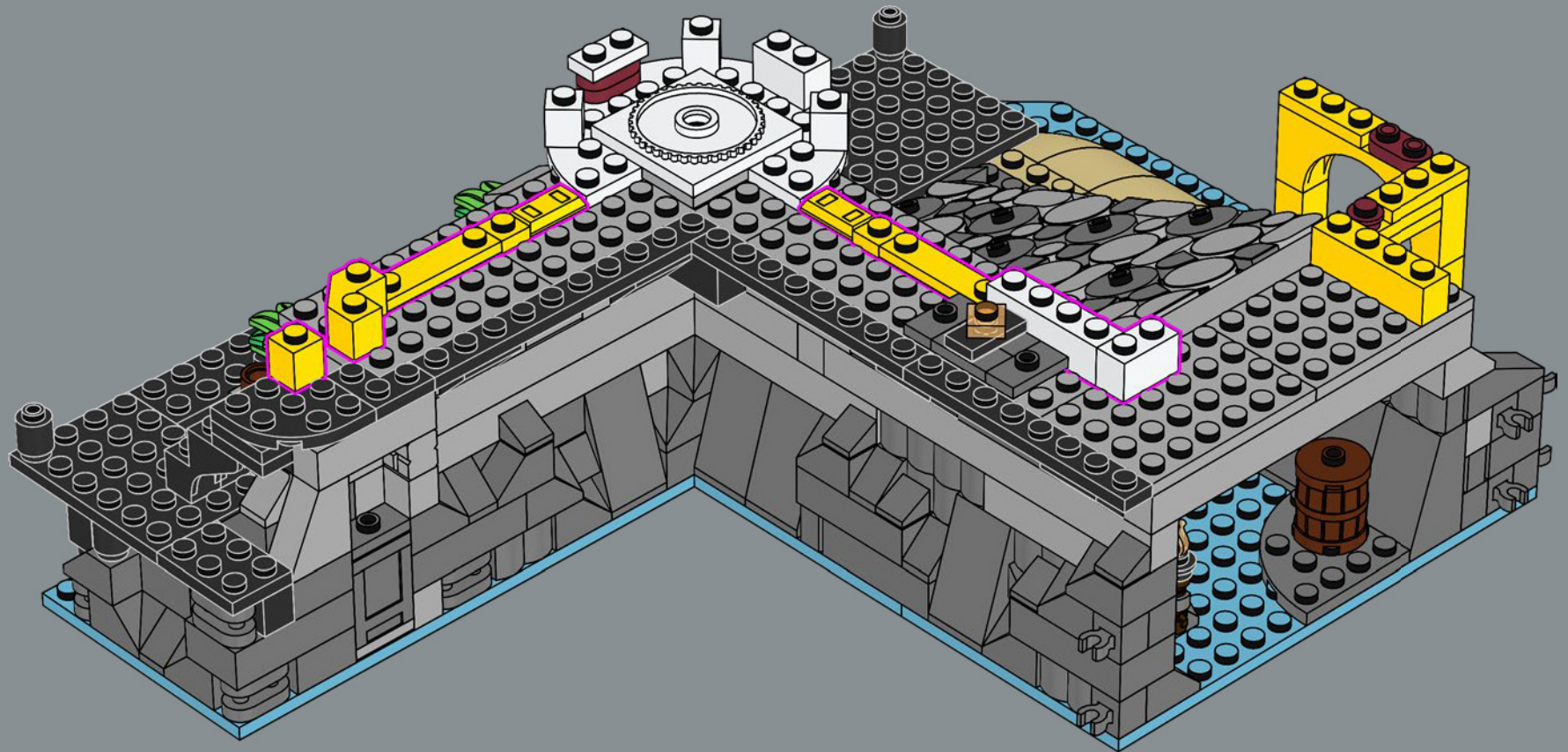



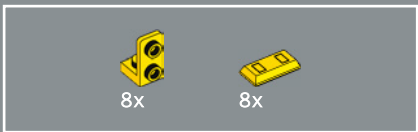

106

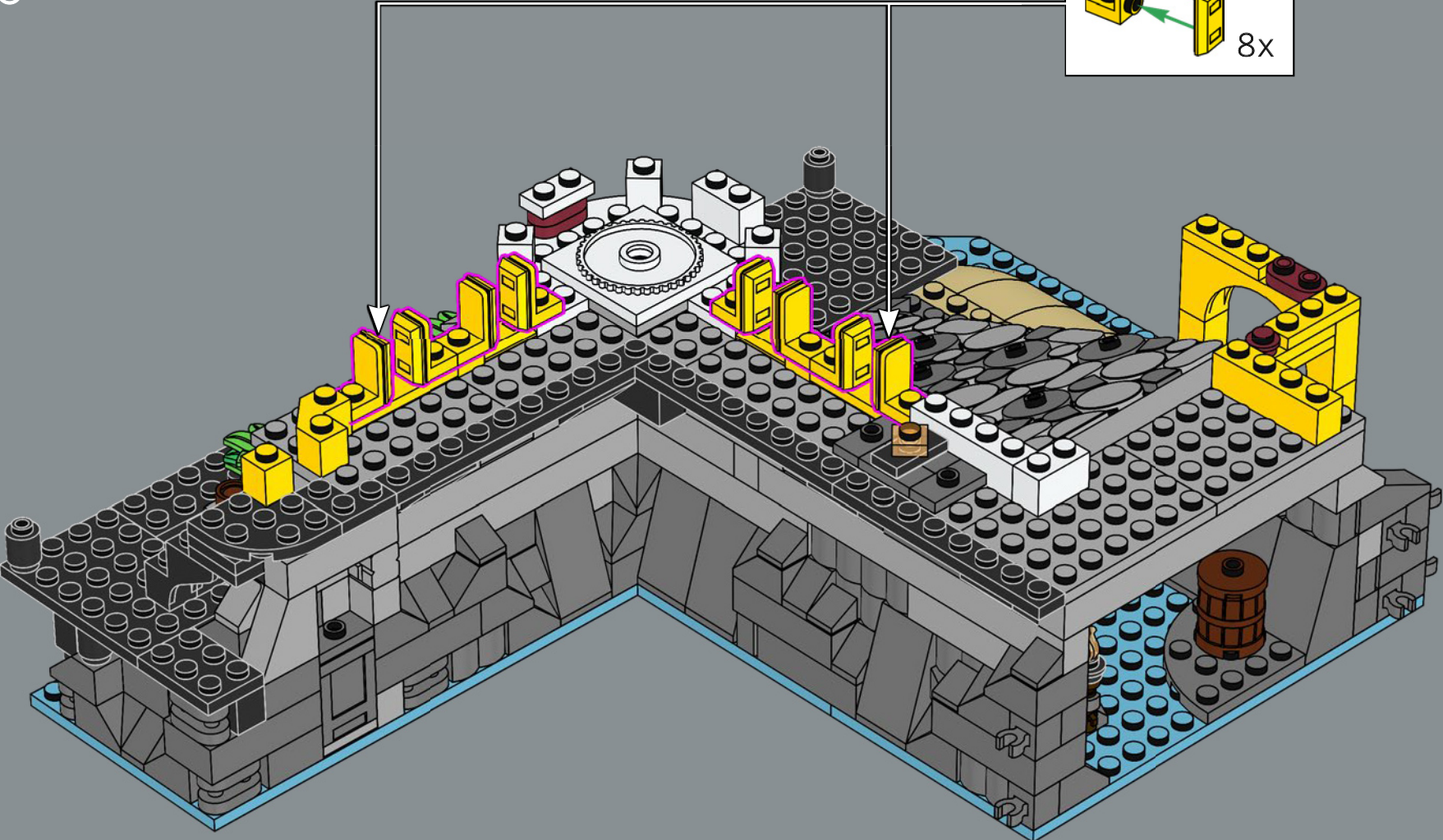
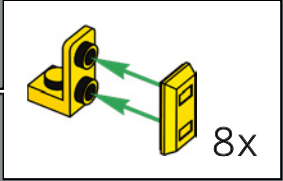



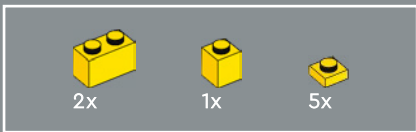

107

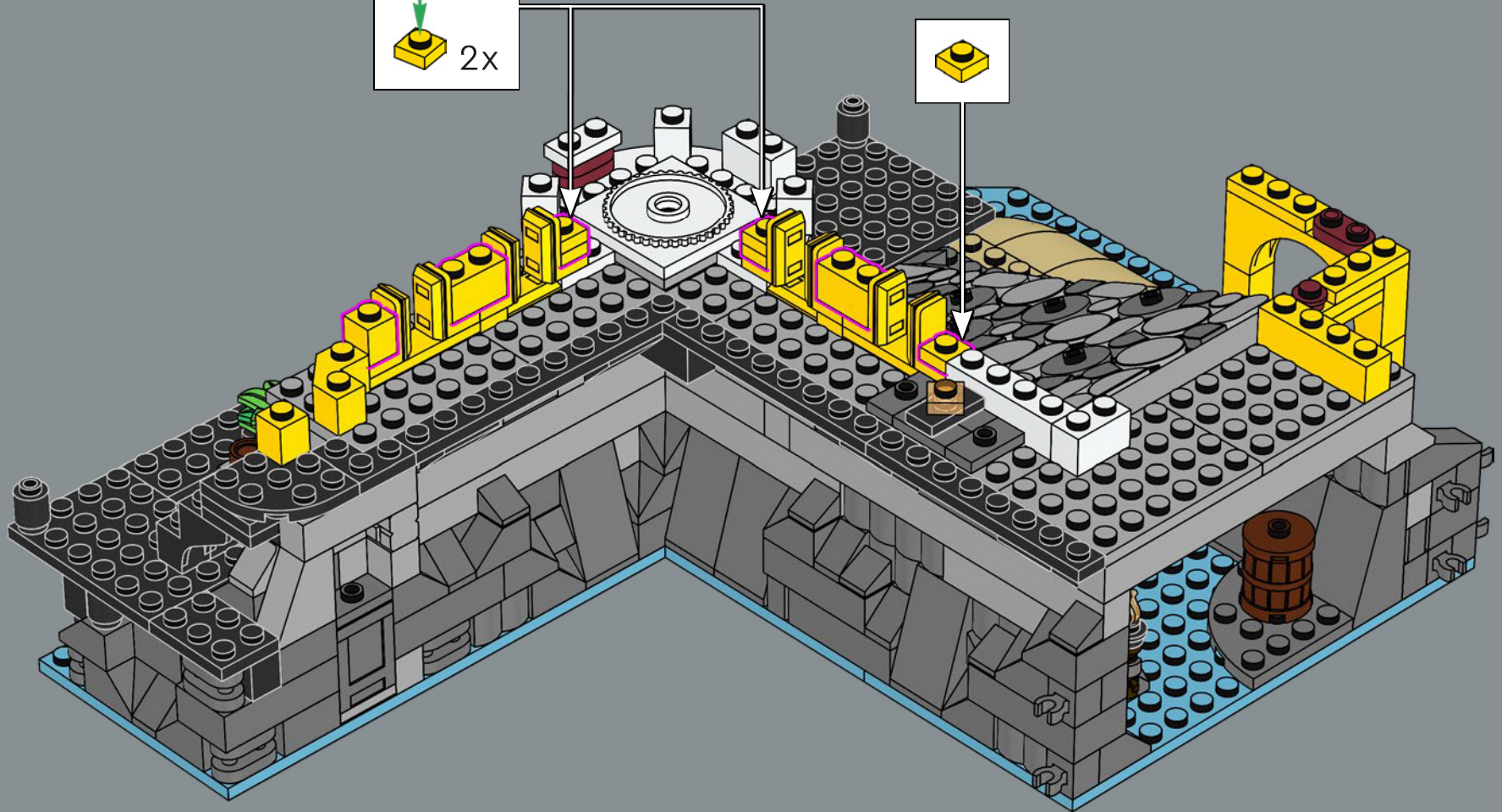
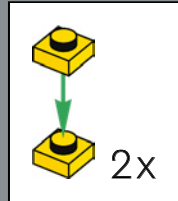



108

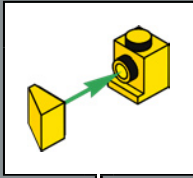
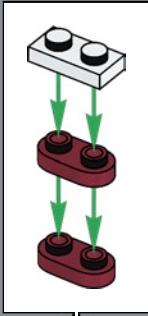



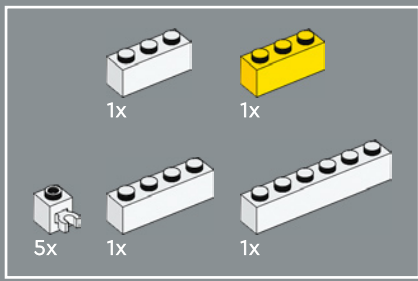

109

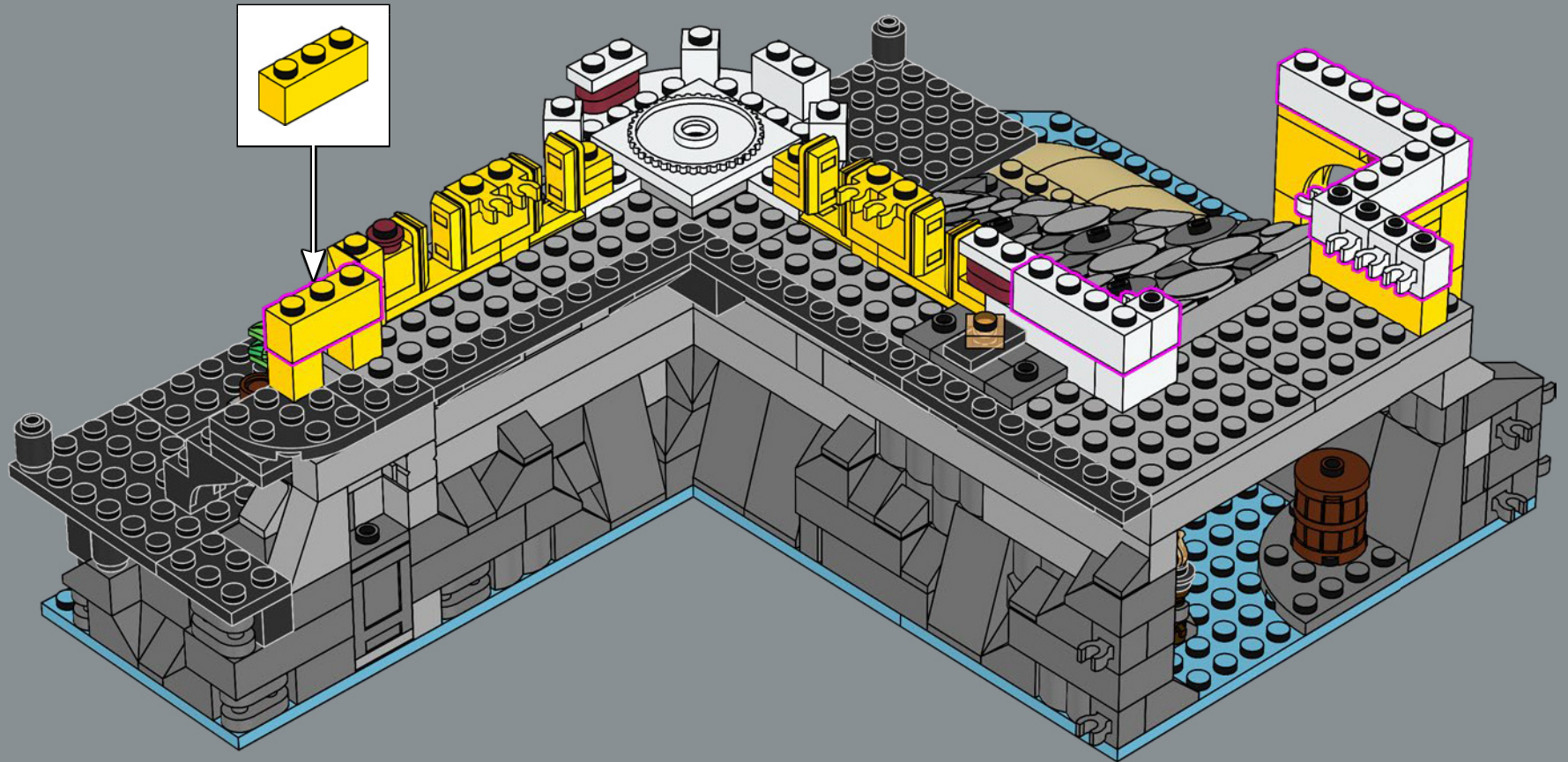



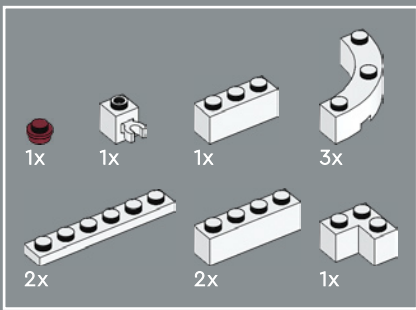

110

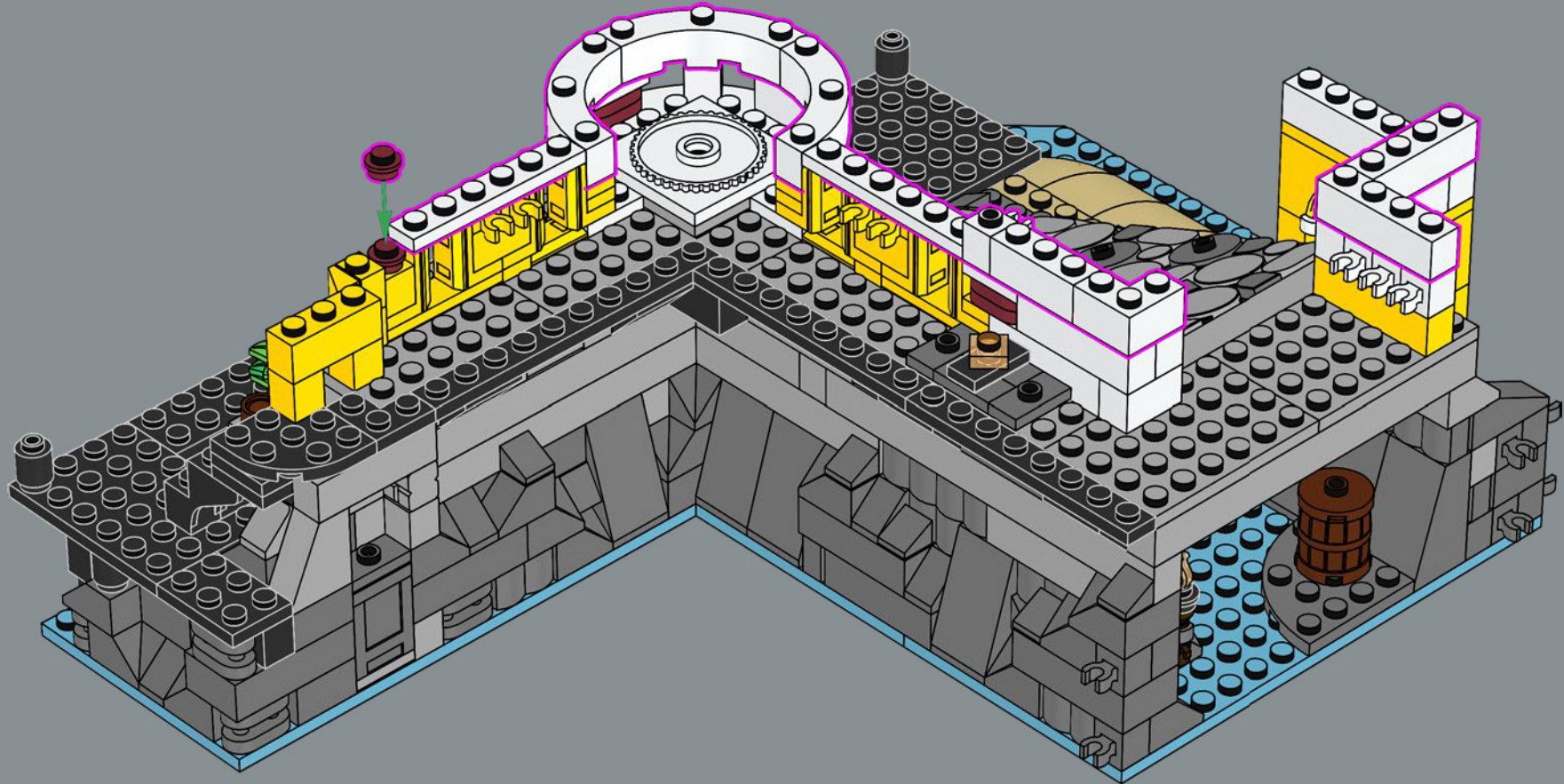

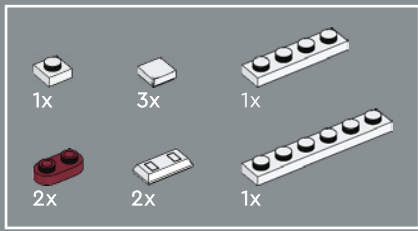

111

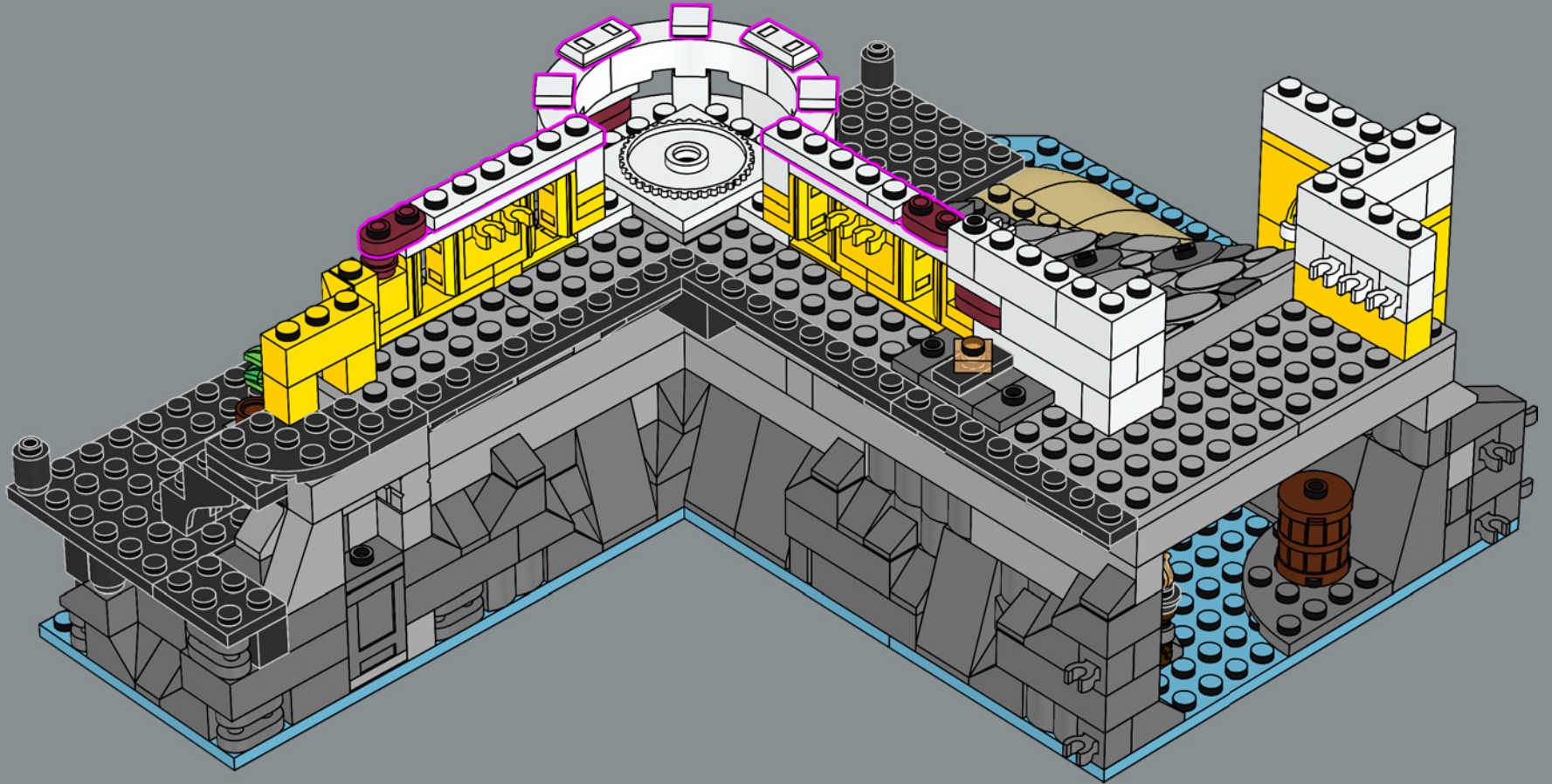



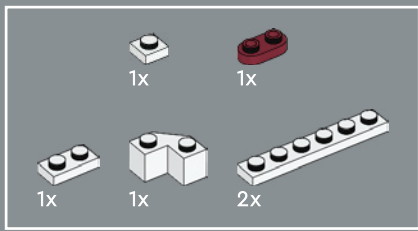

112

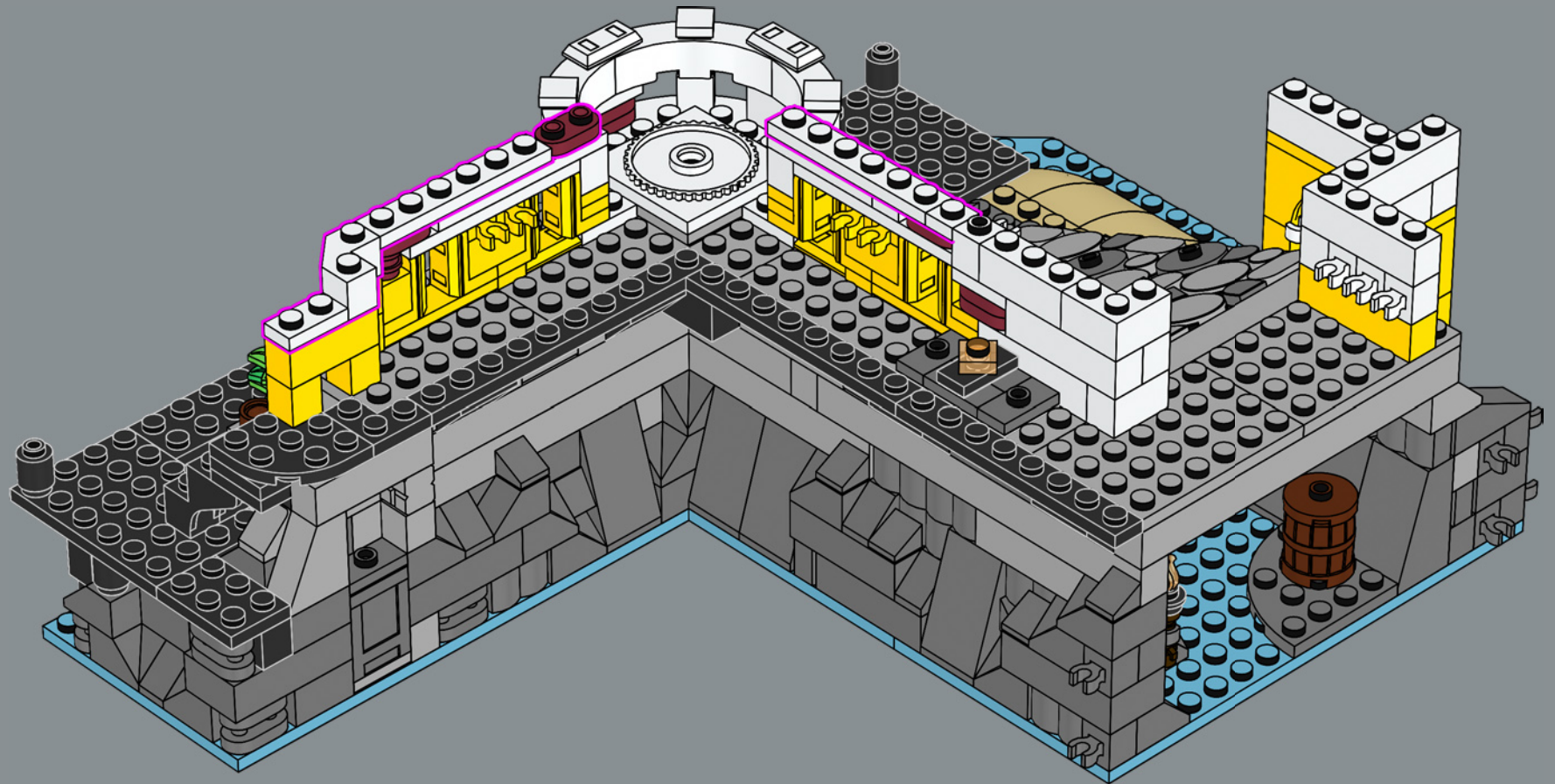



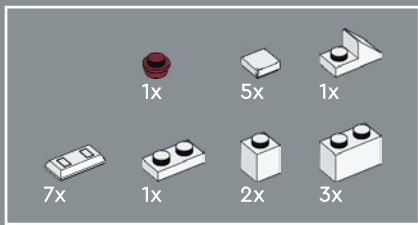

113

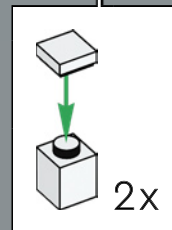
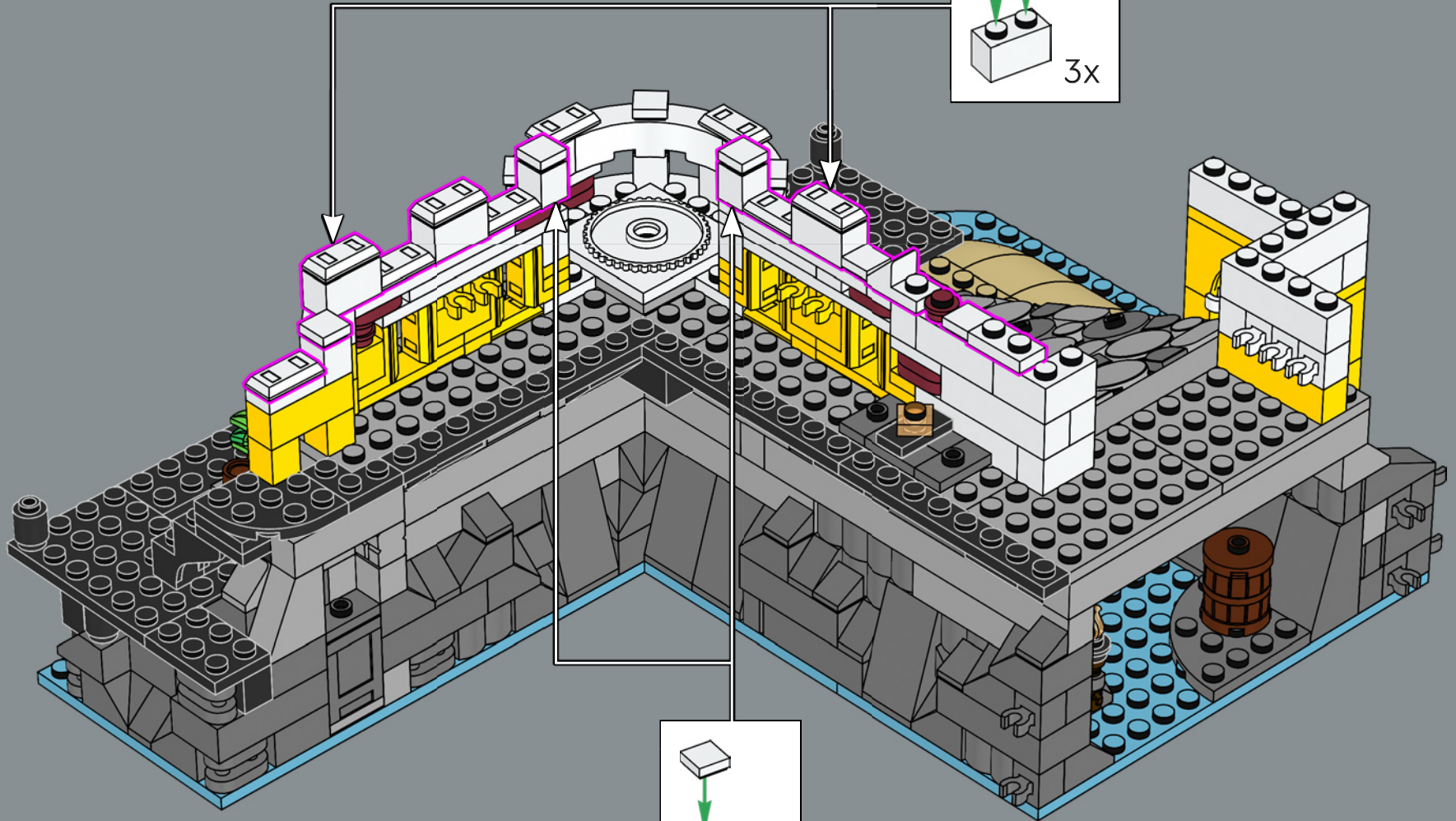
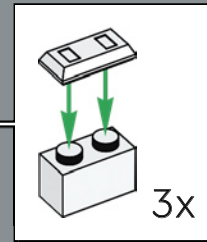

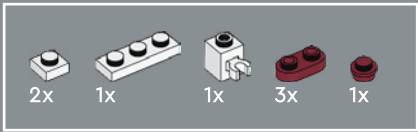

114

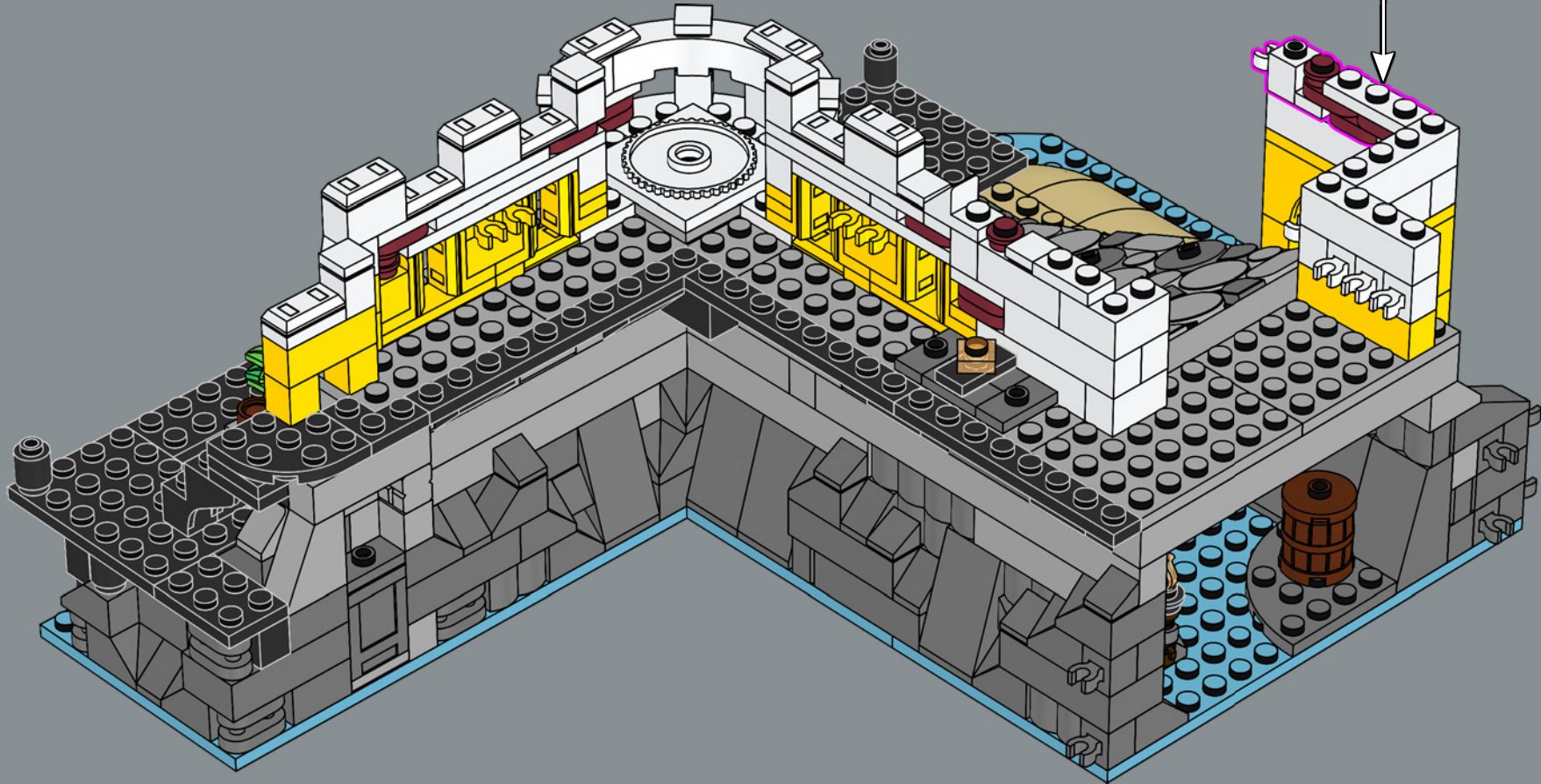
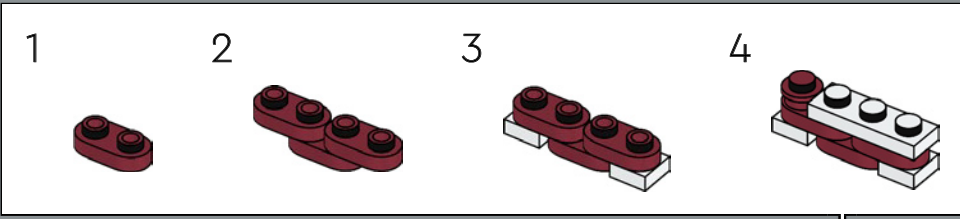



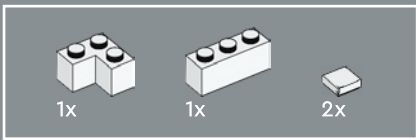

115

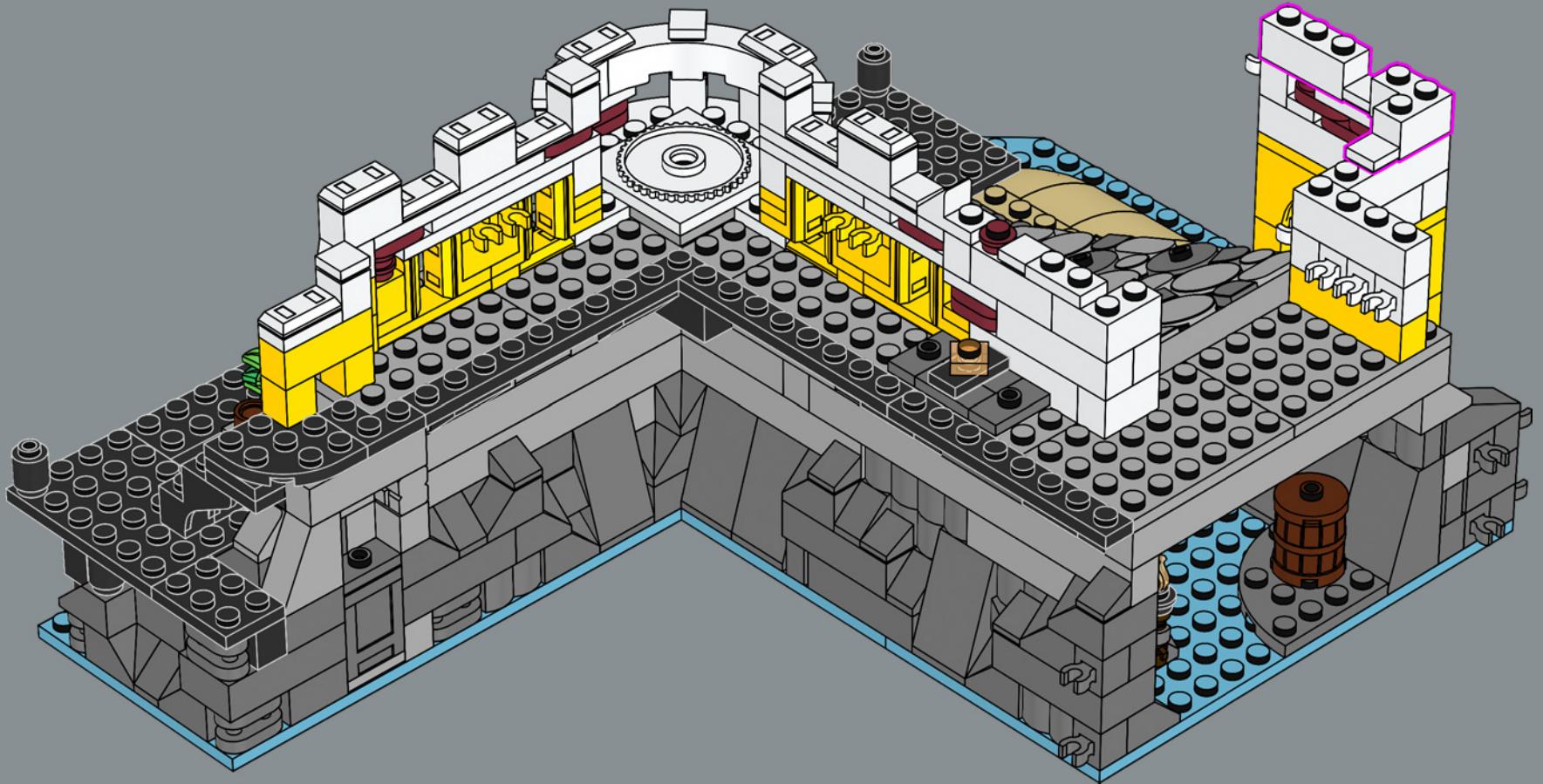



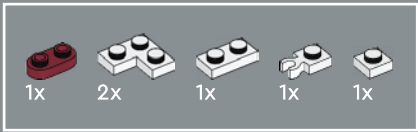

116

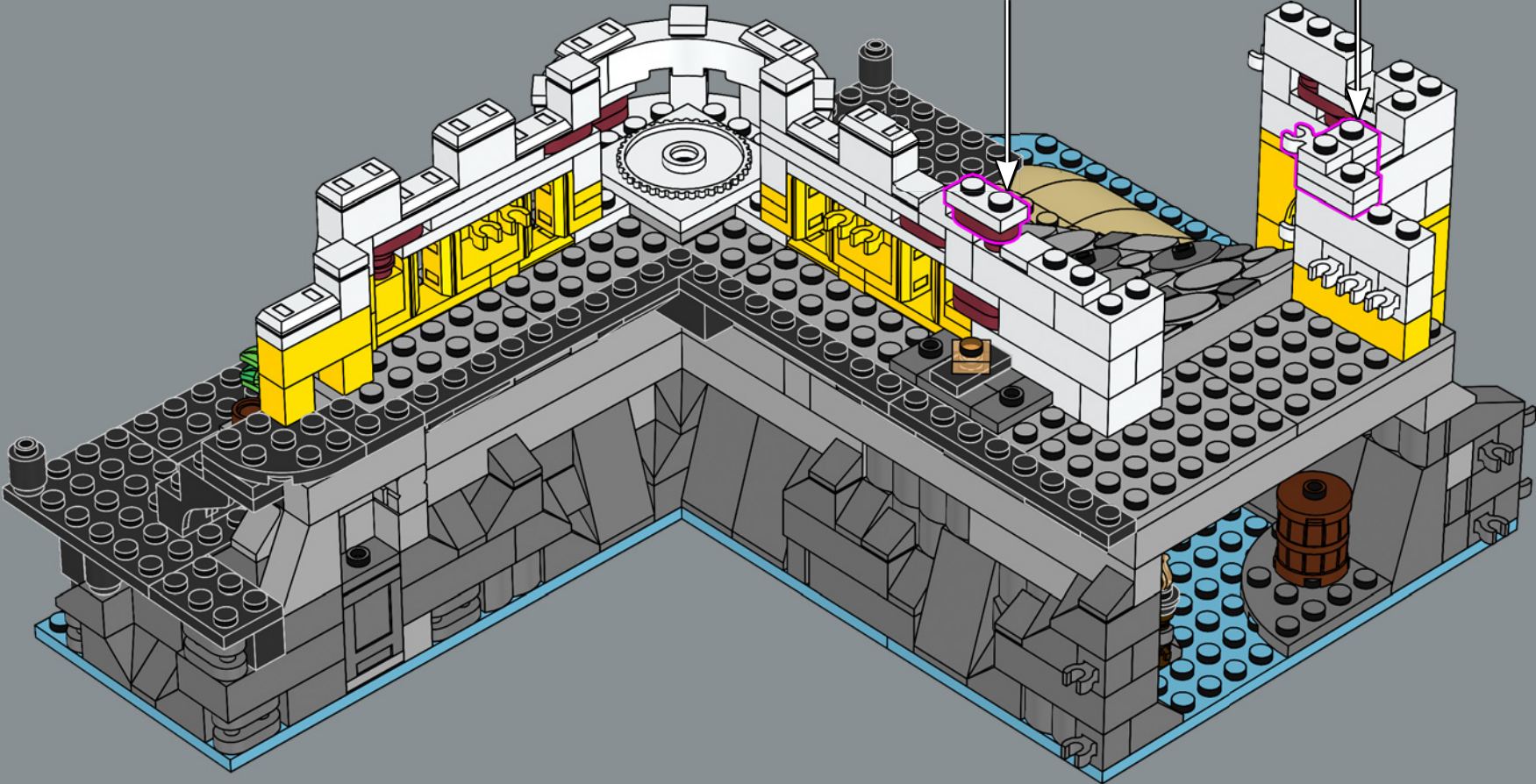
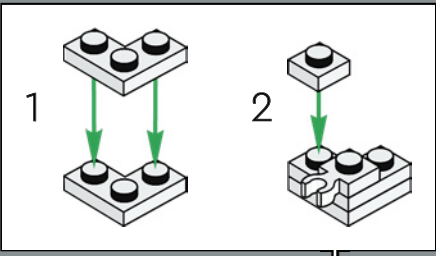
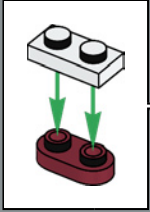



117

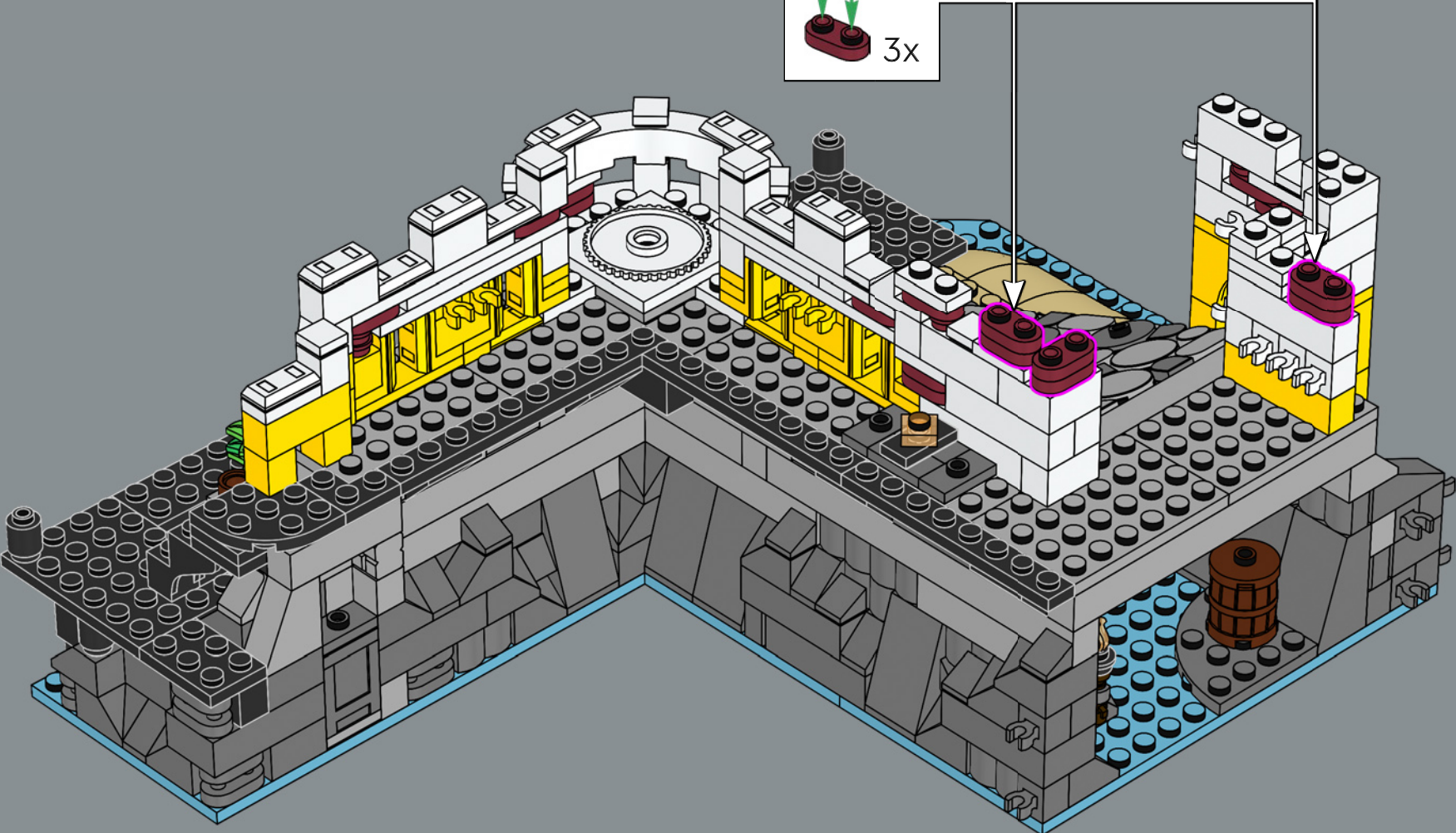
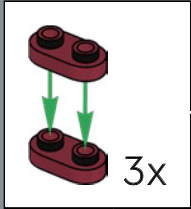



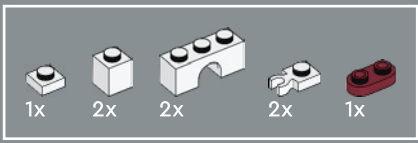

118

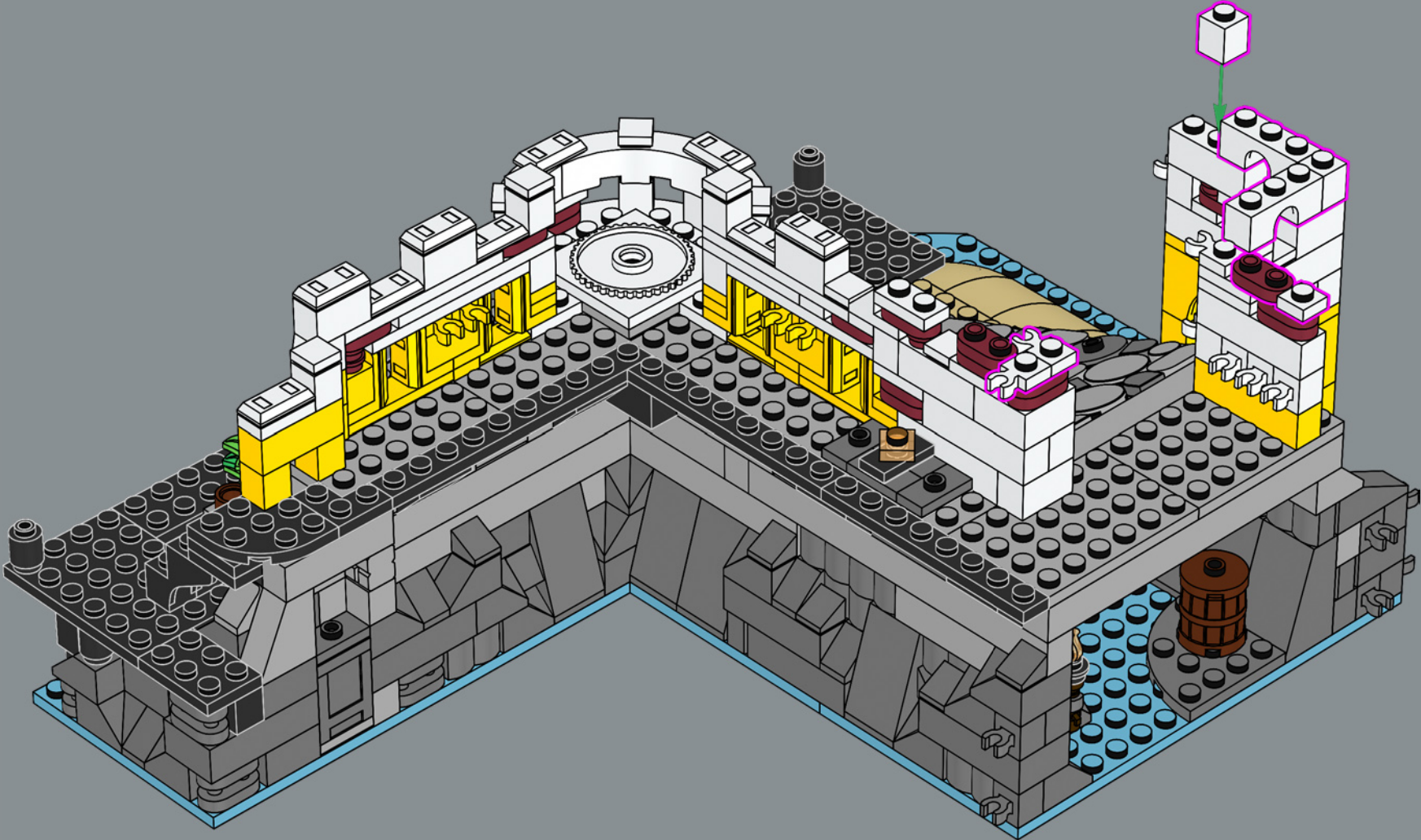



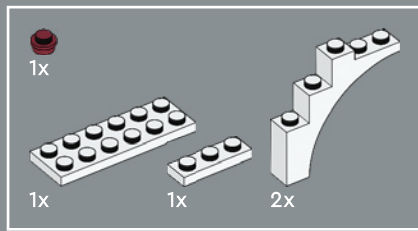

119

1

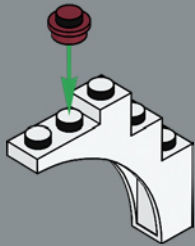

2

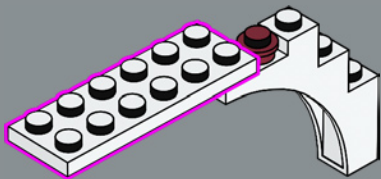

3

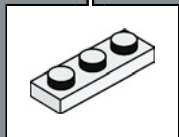
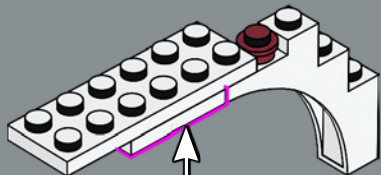

4

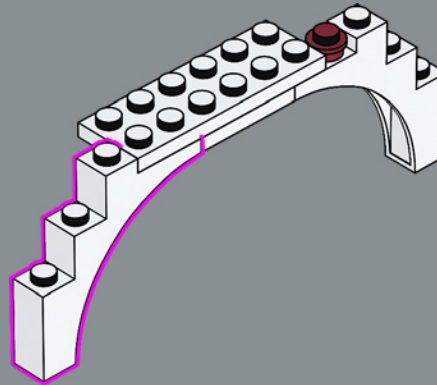

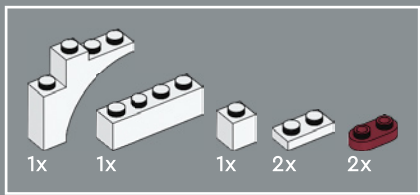

120

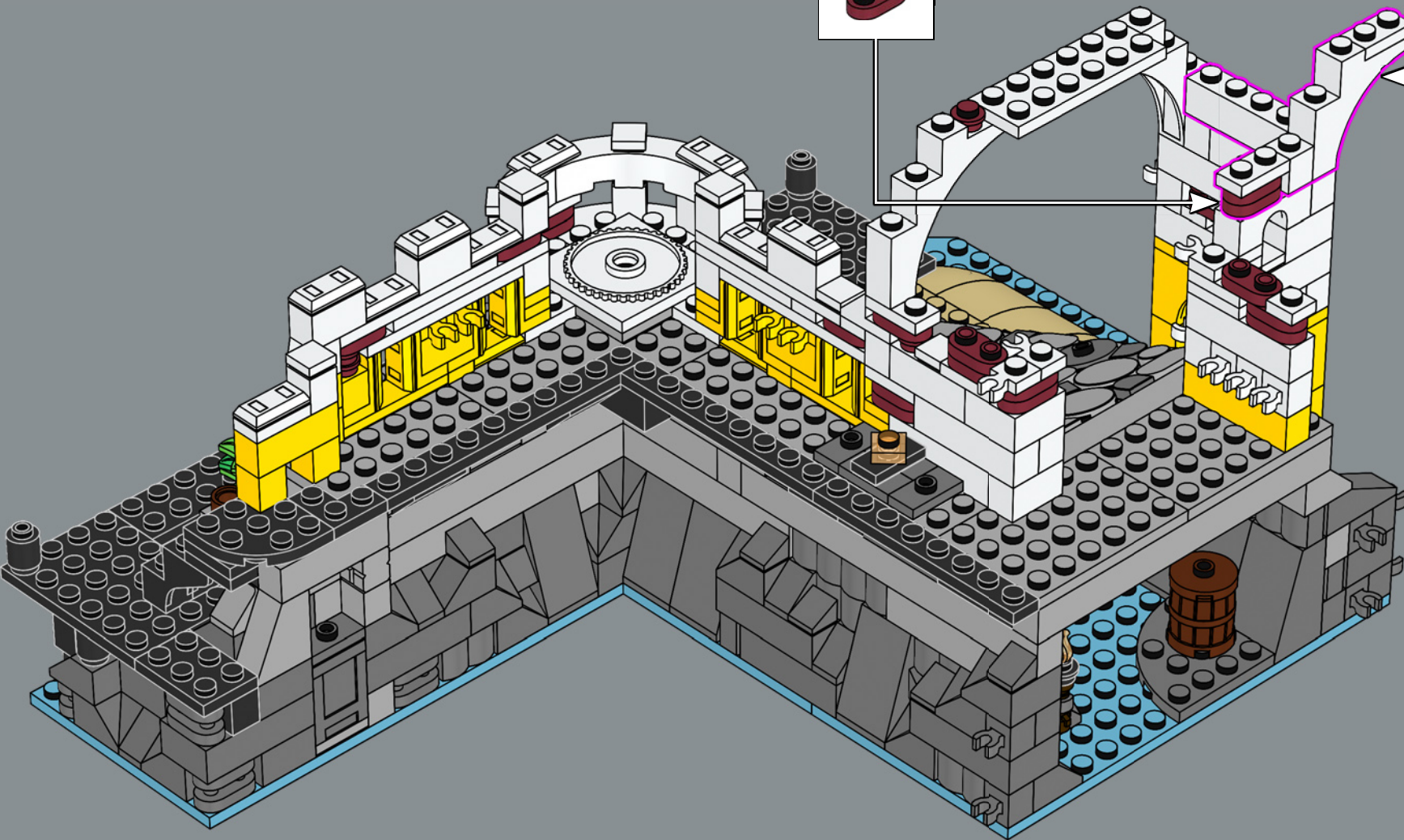
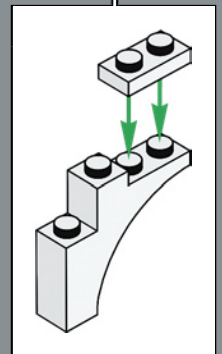
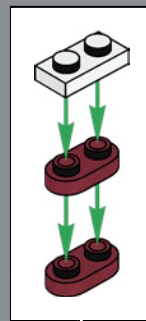



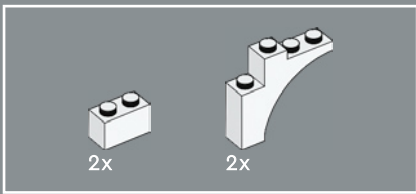

121

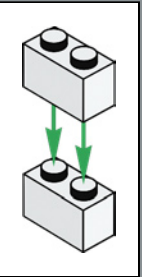
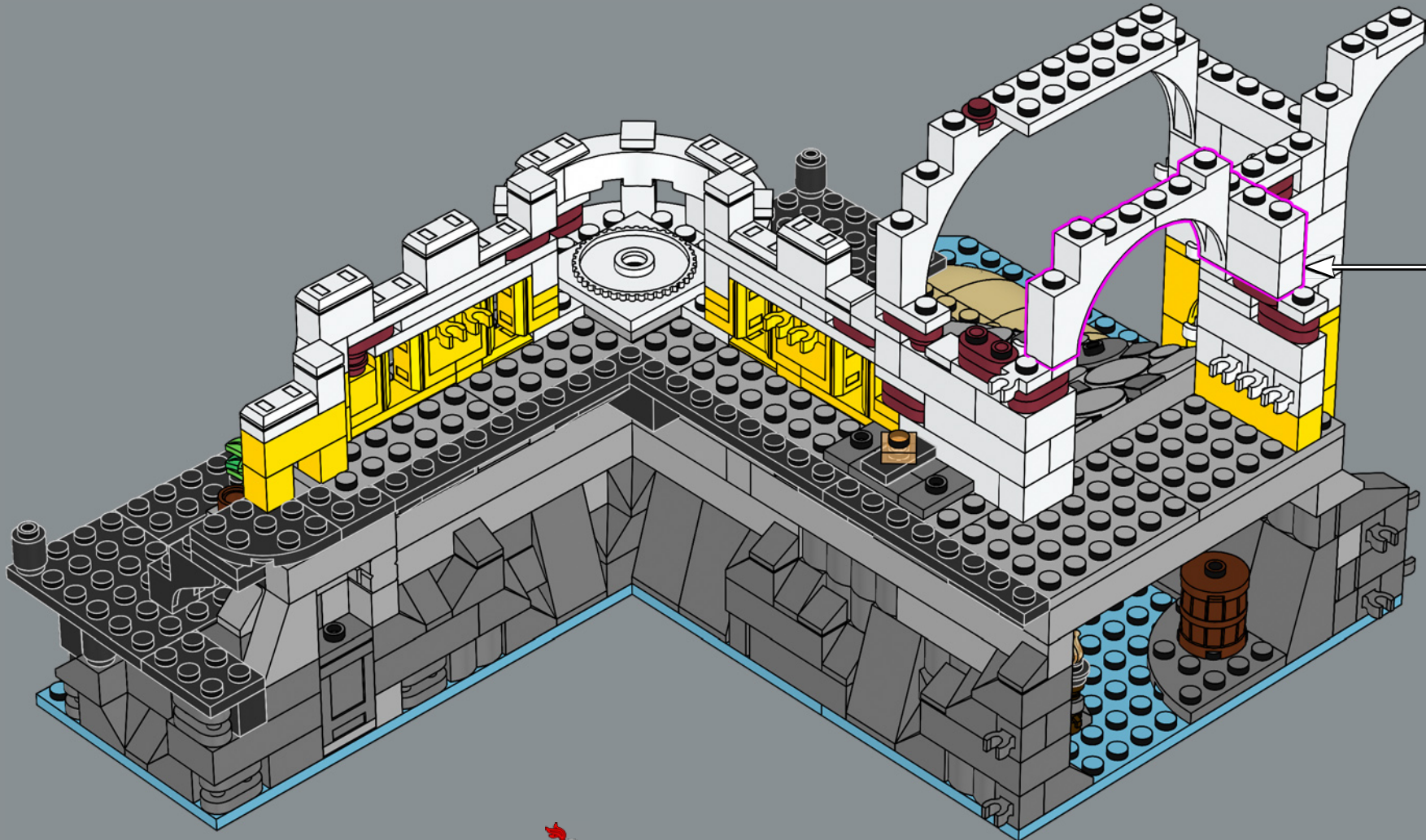



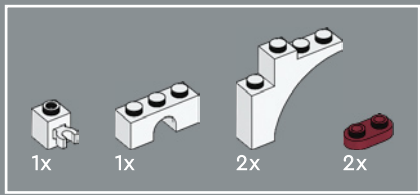

122

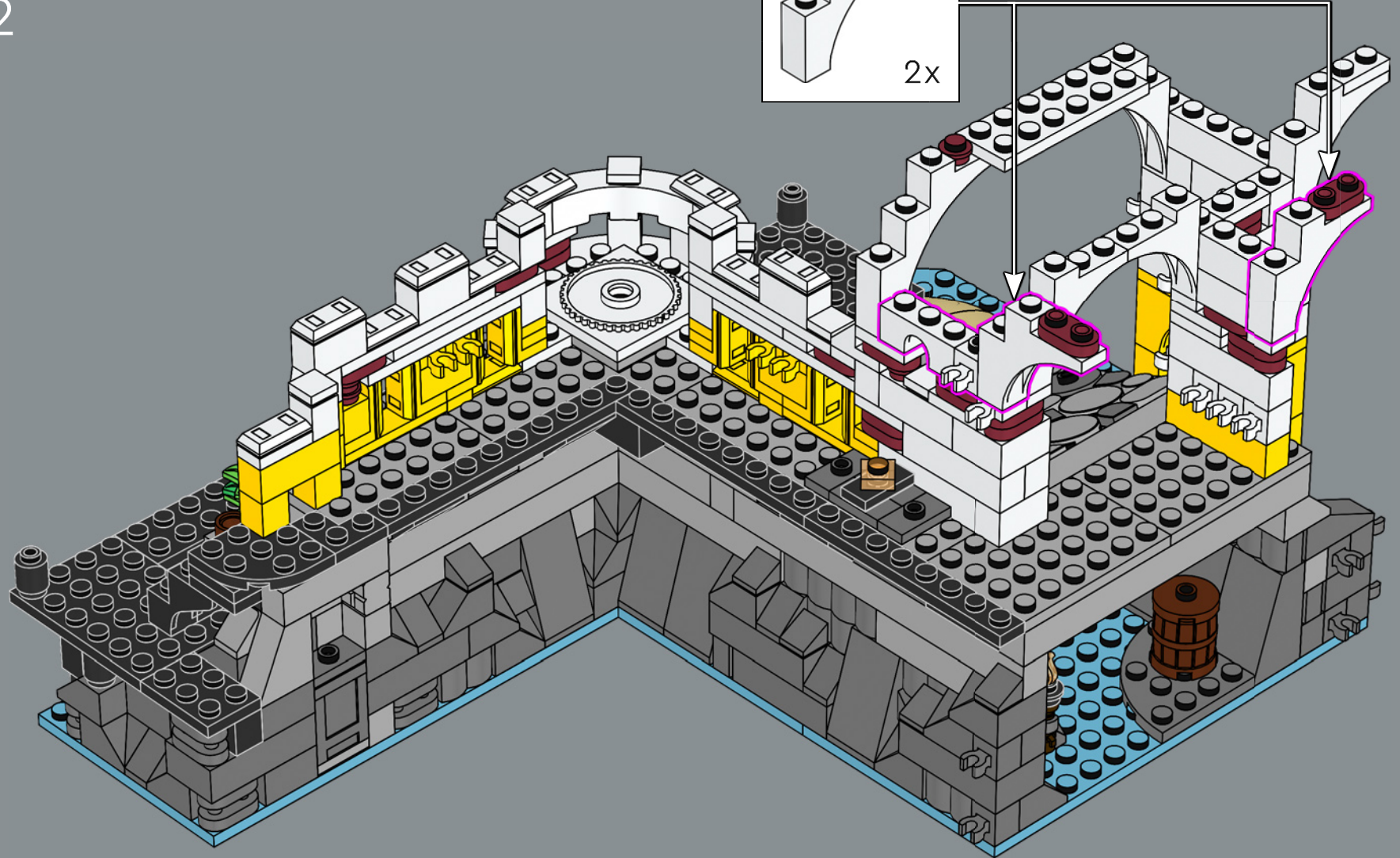
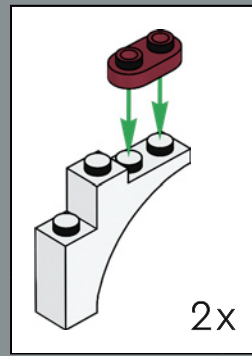



123

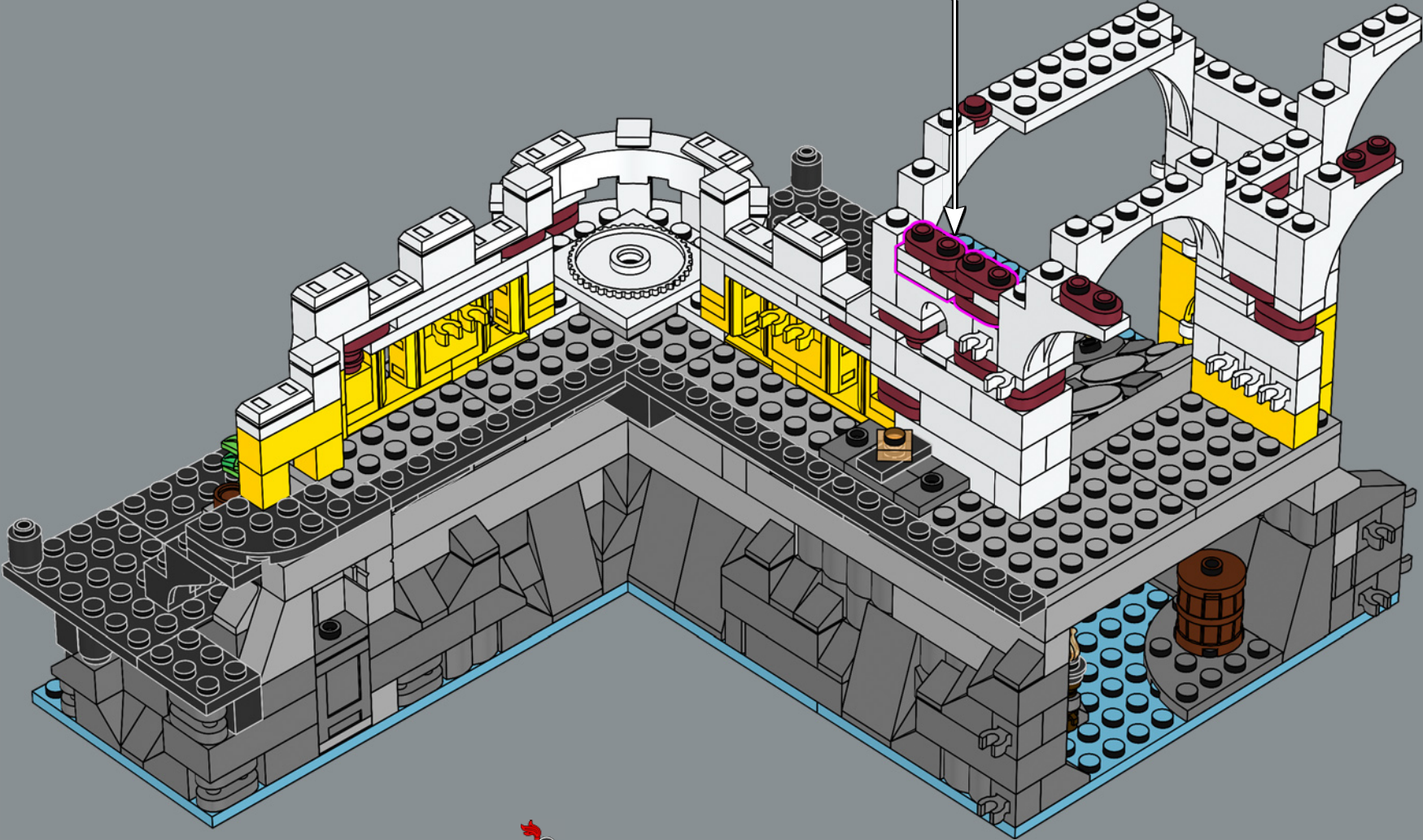
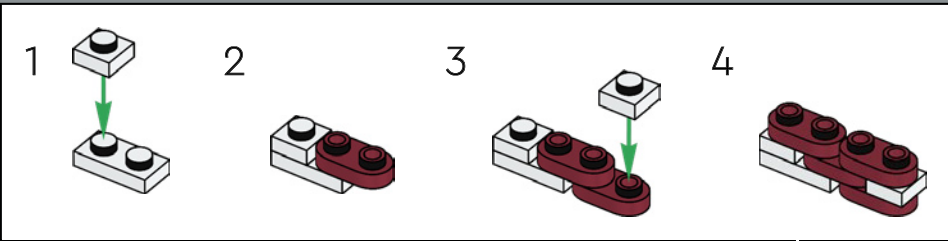



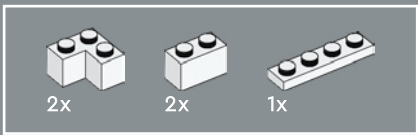

124

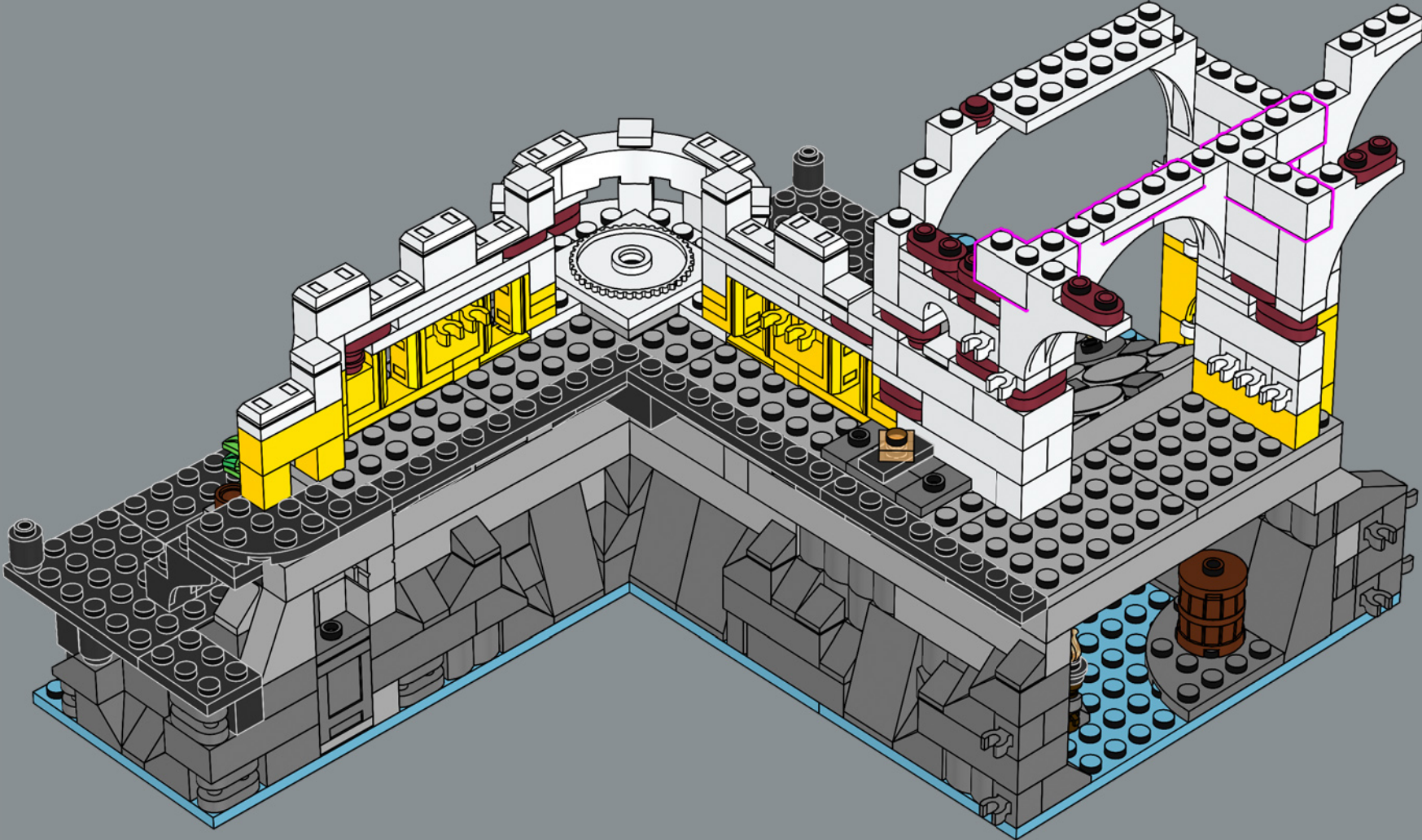



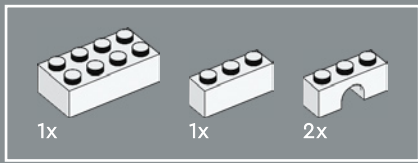

125

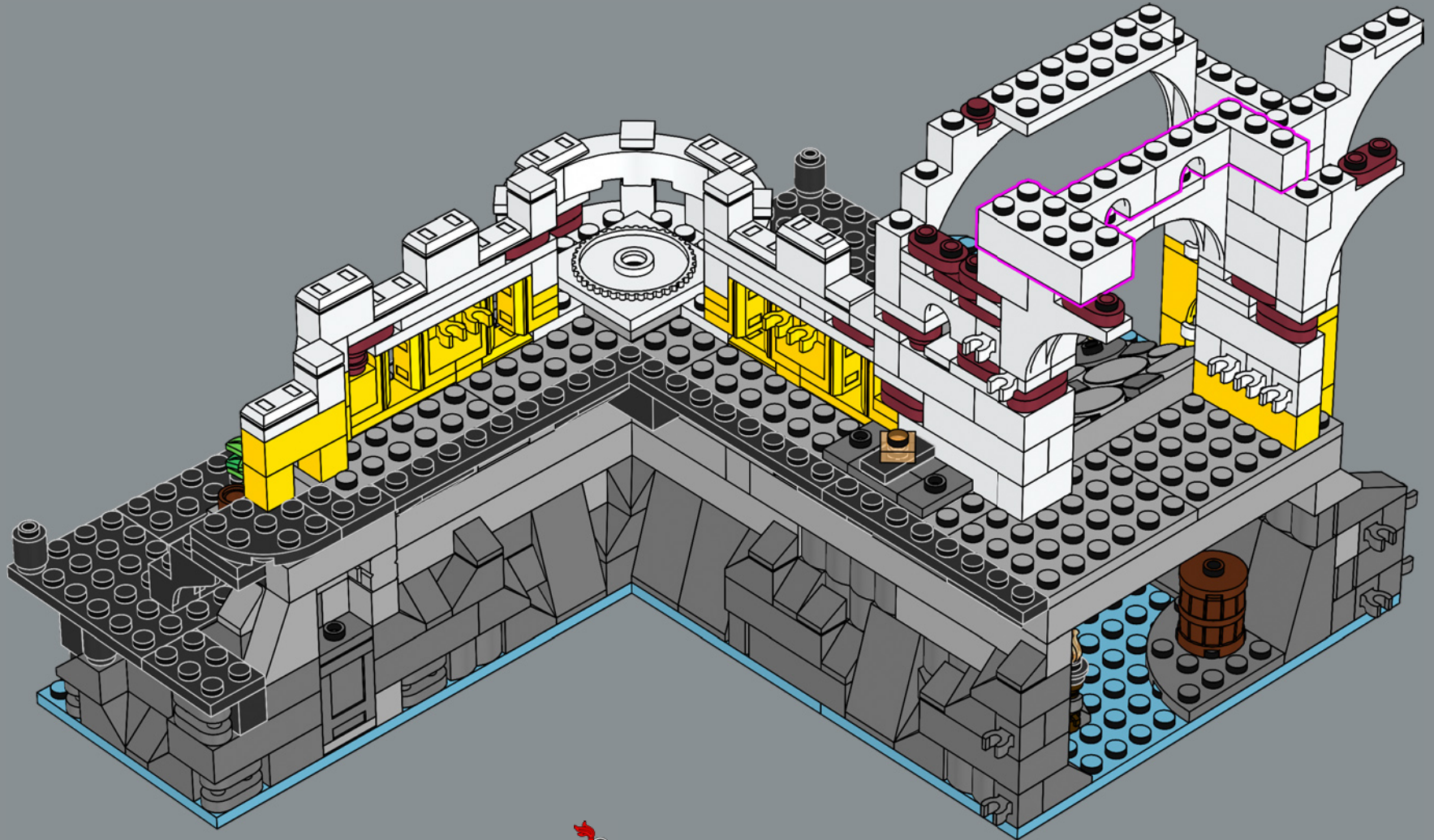

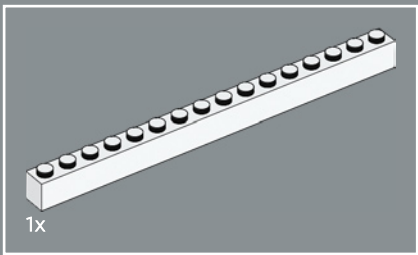

126

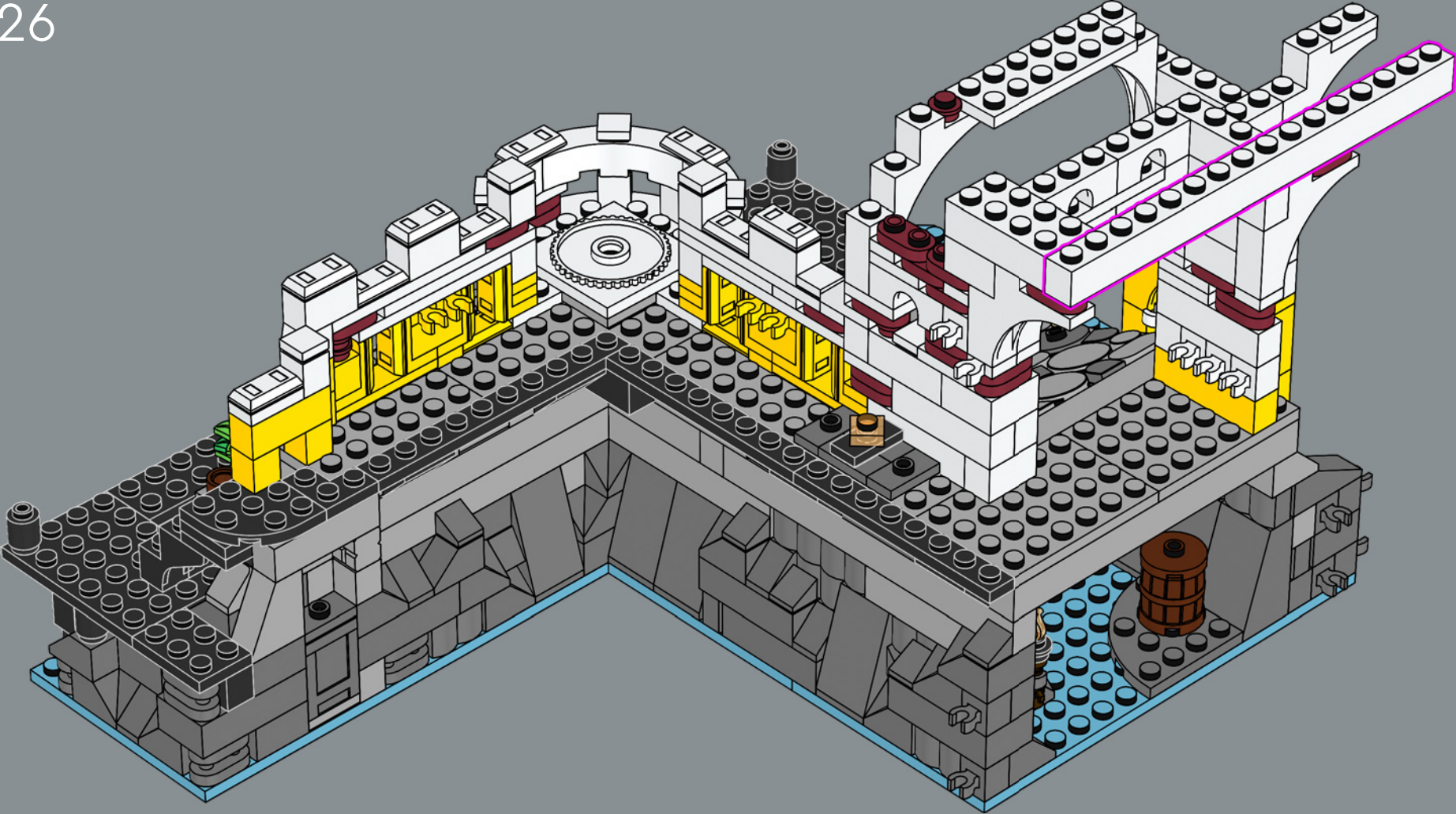



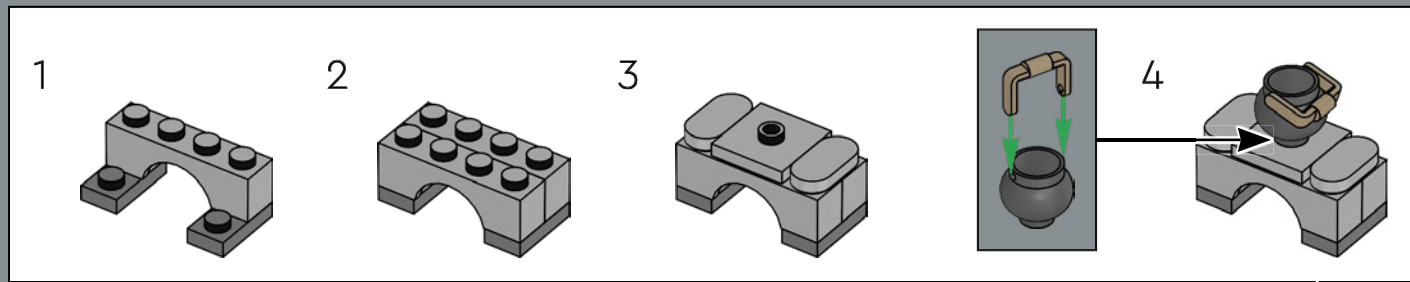
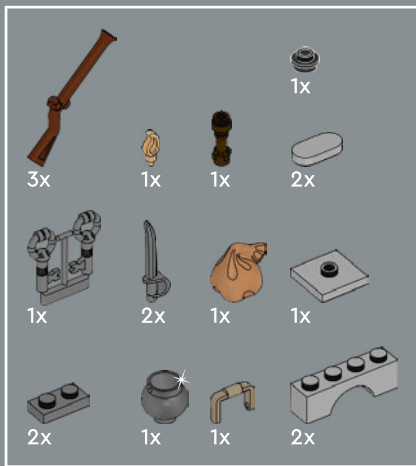

127



Seeleute, Piraten und sogar Wachen brauchen etwas zu essen! Was gibt es heute? Fisch? Kokosnüsse? Spitzwegerich?

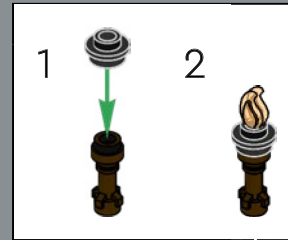



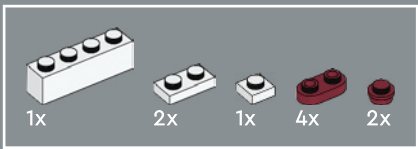

128

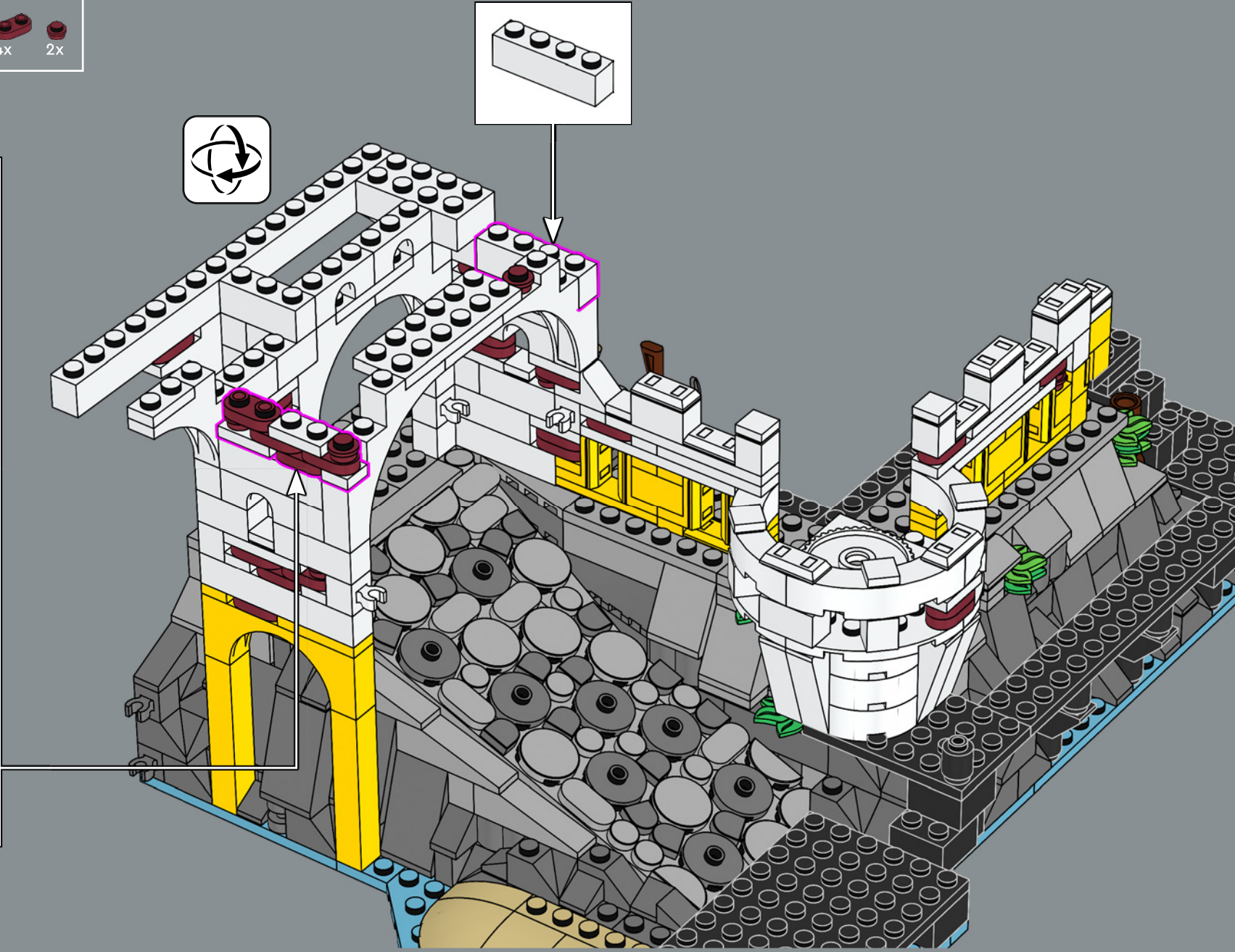
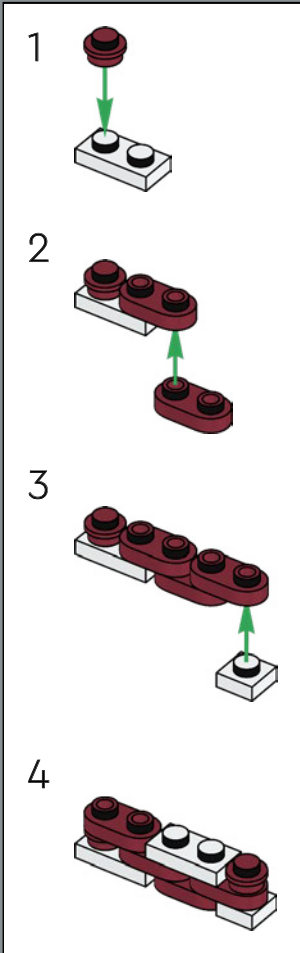
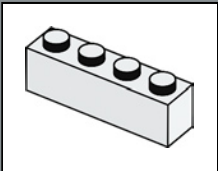

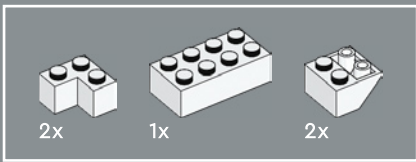

129

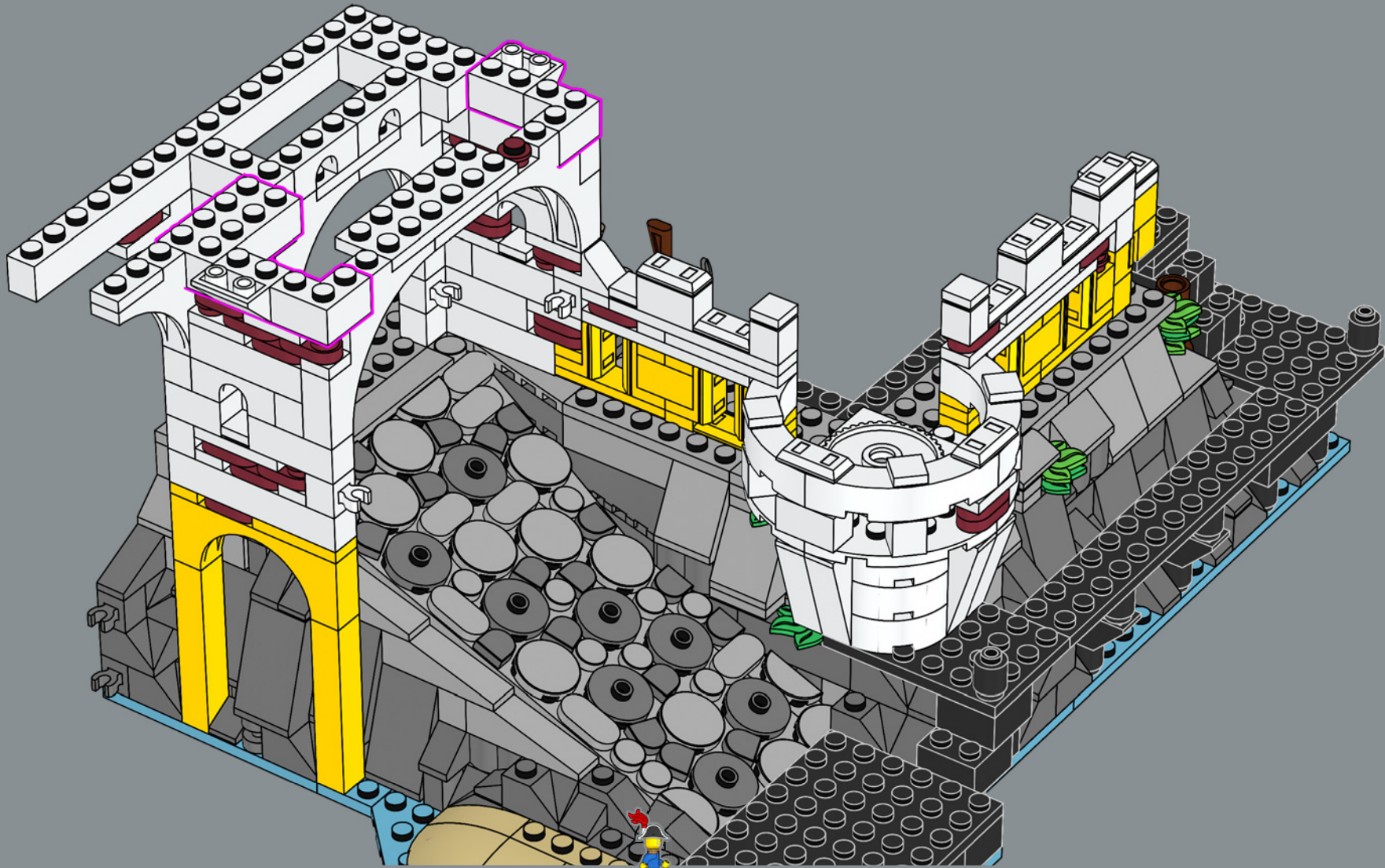



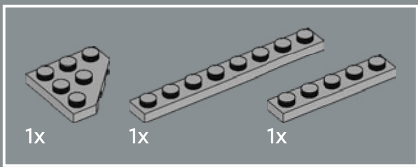

130

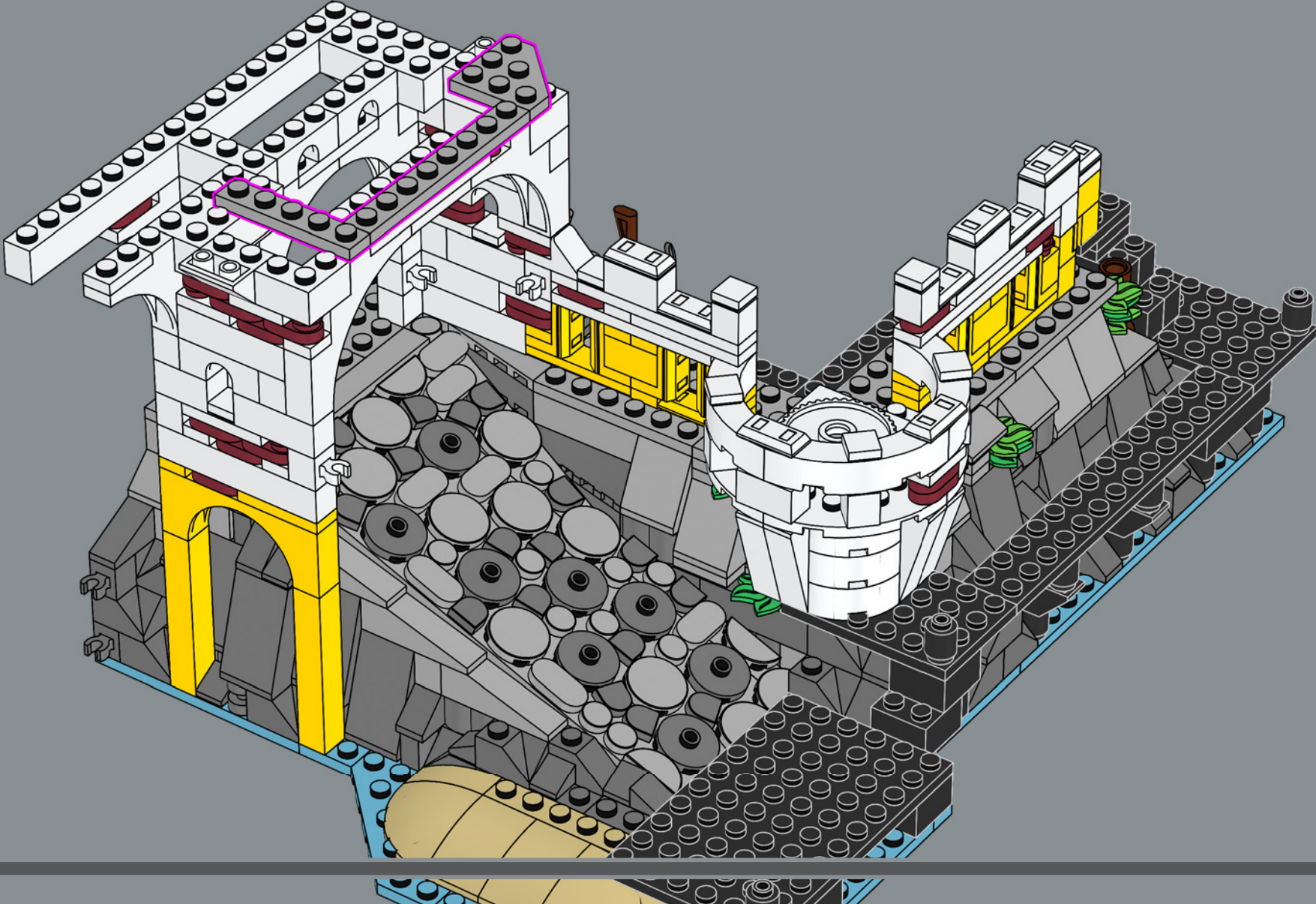



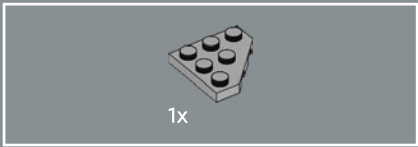

131

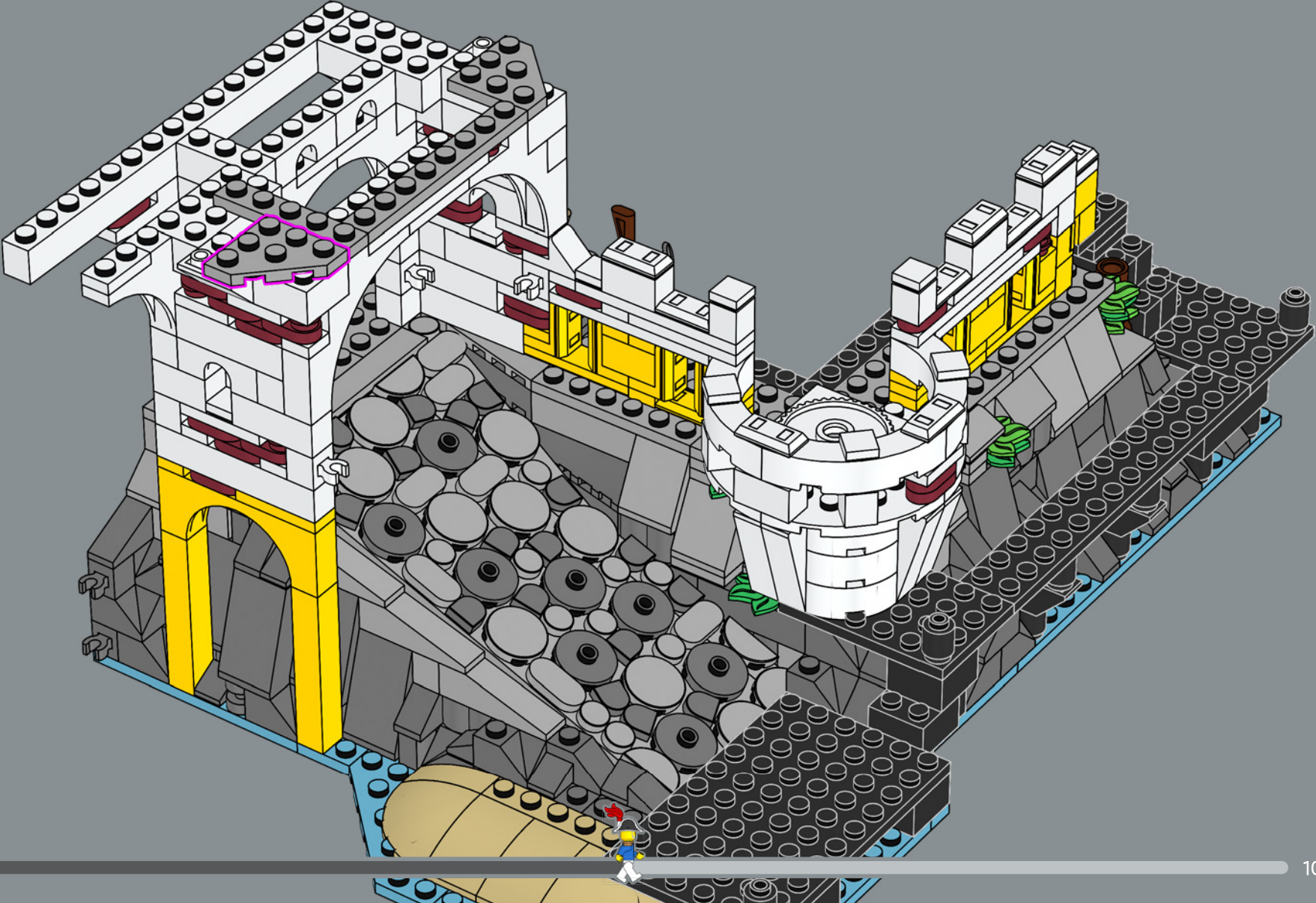



132

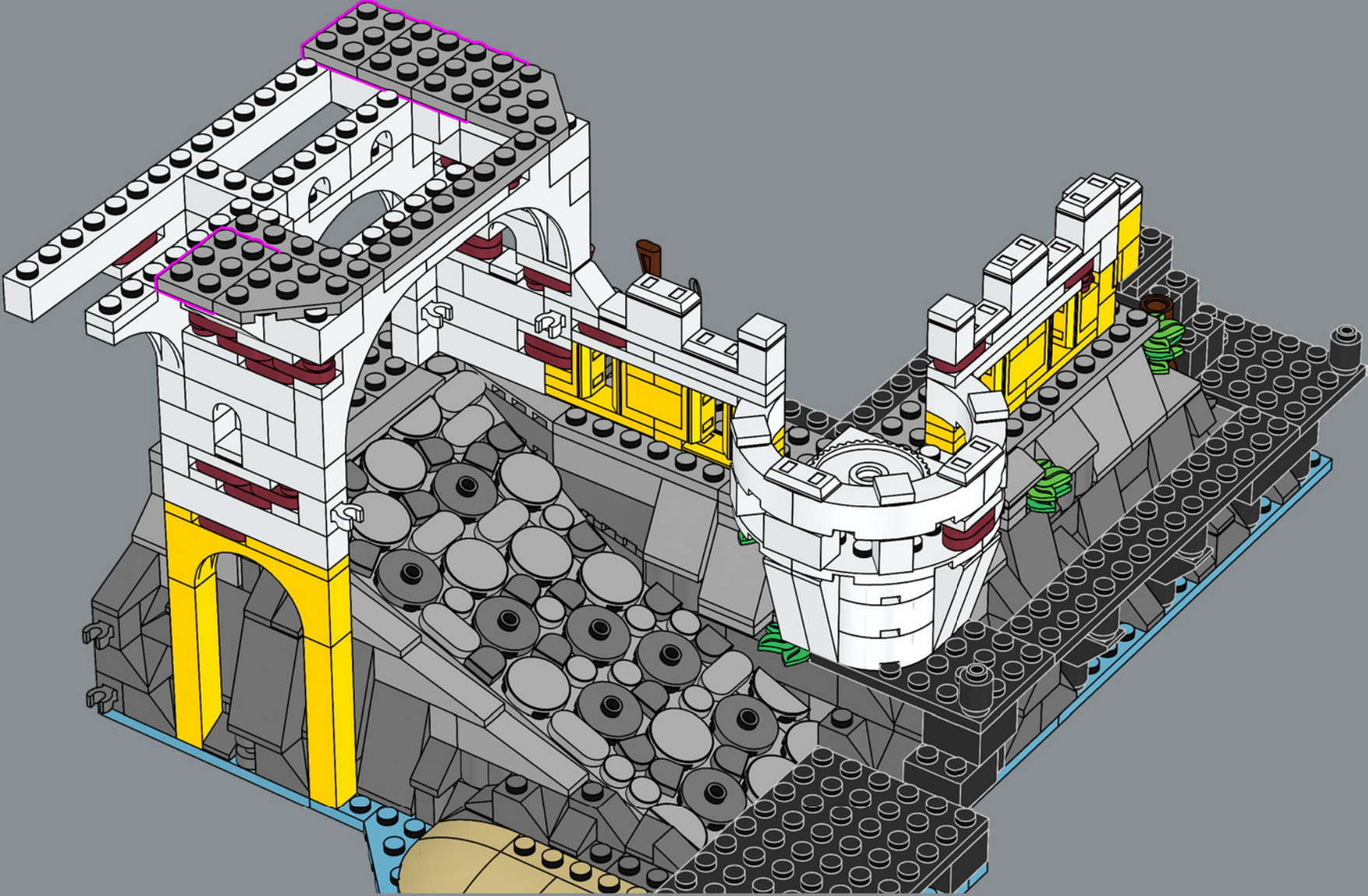



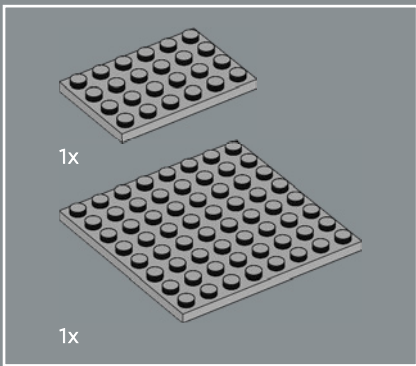

133

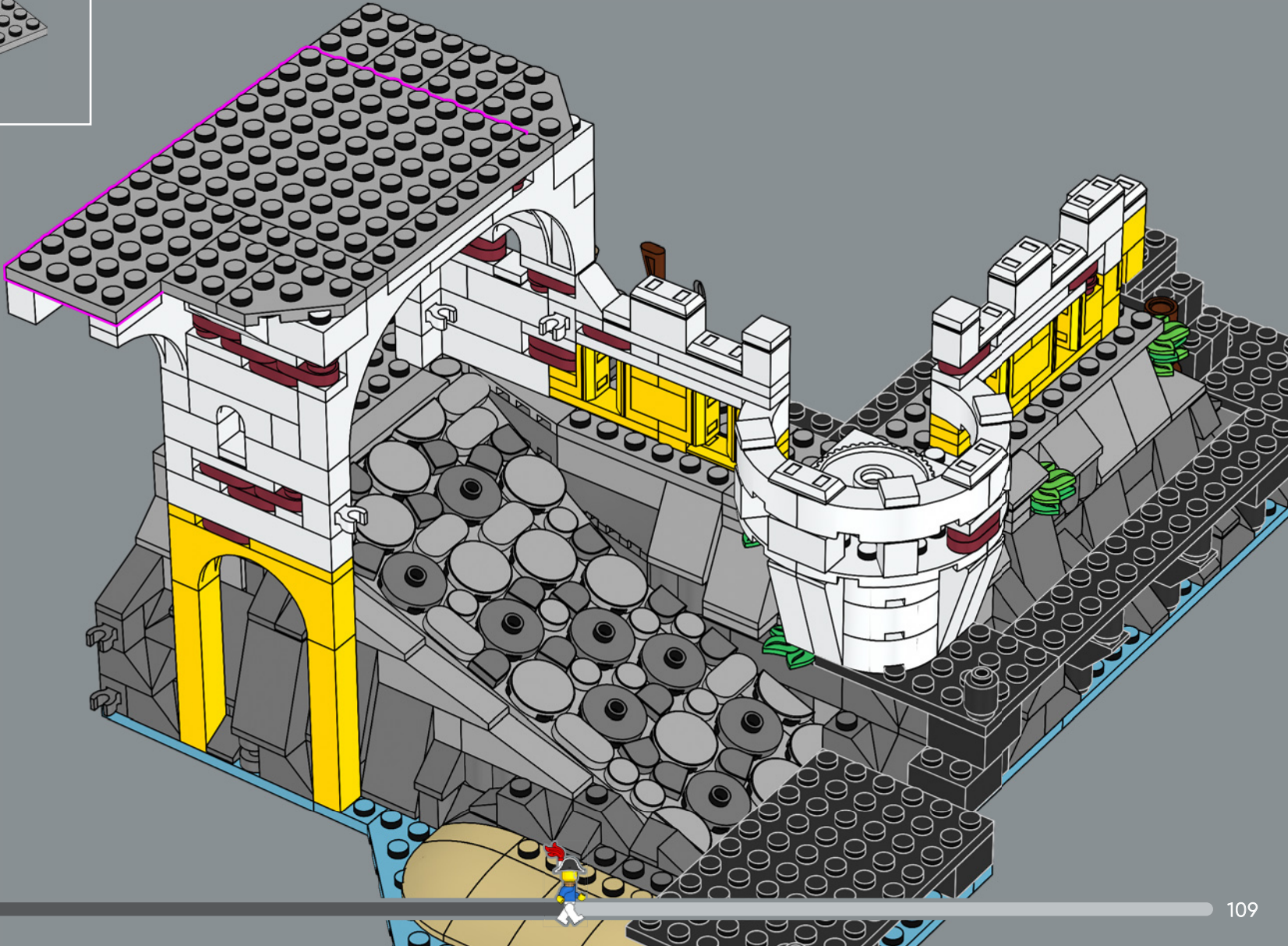



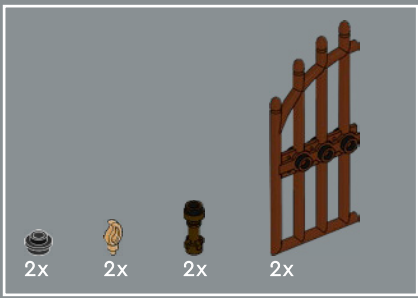

134

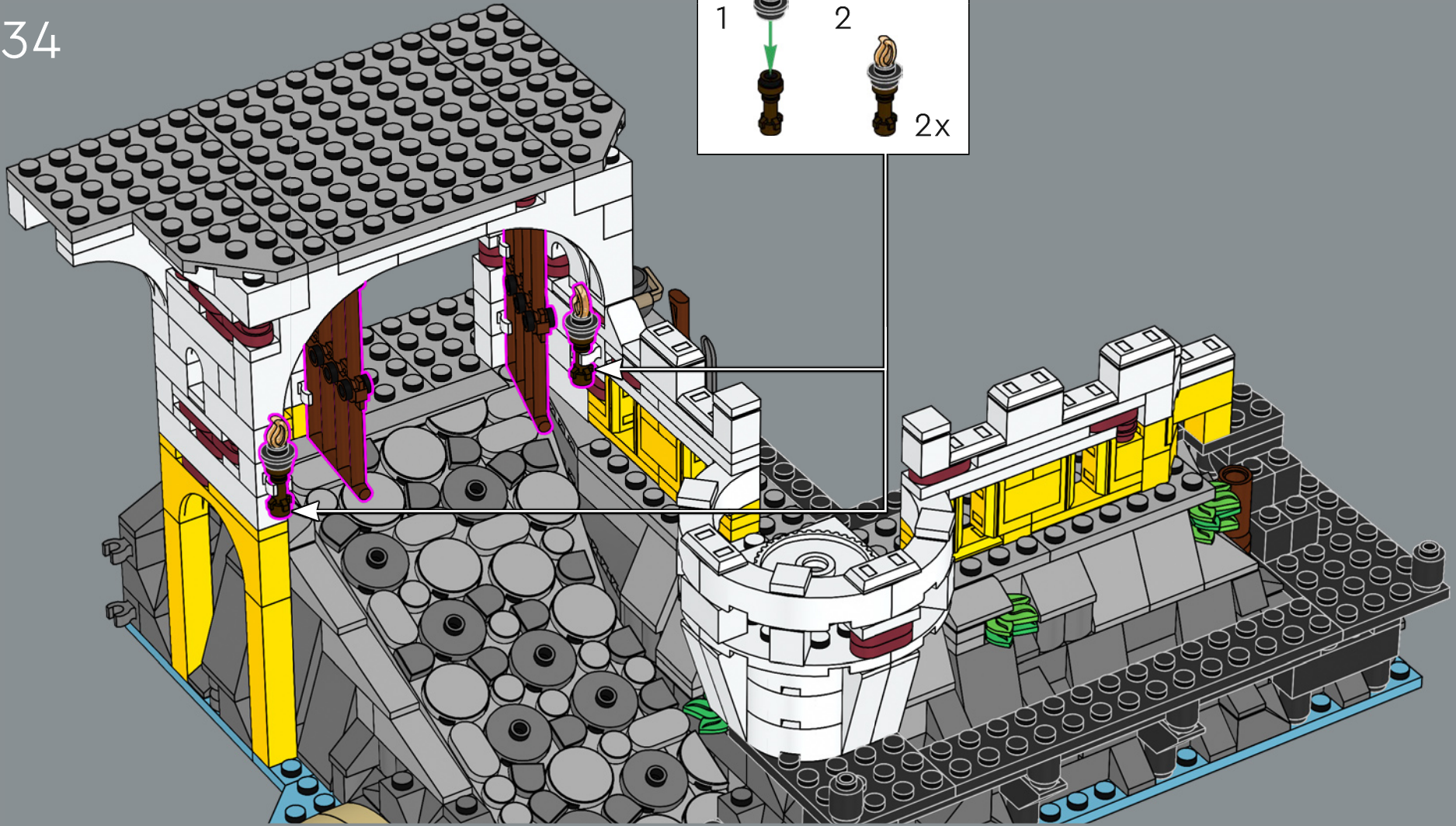
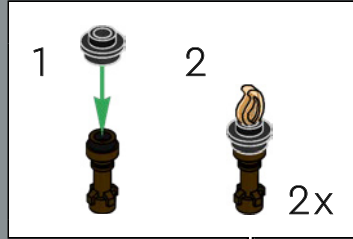

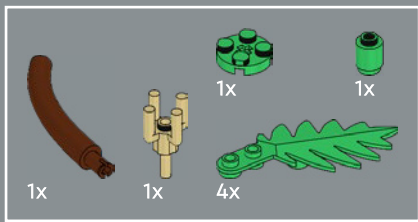

135

1

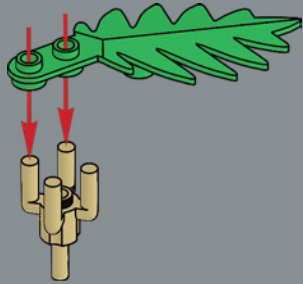

2

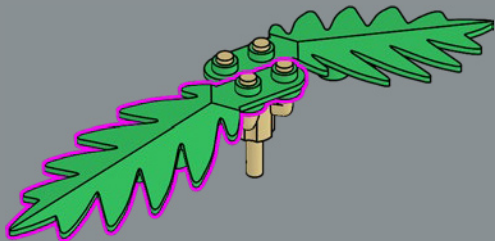

3



4



5





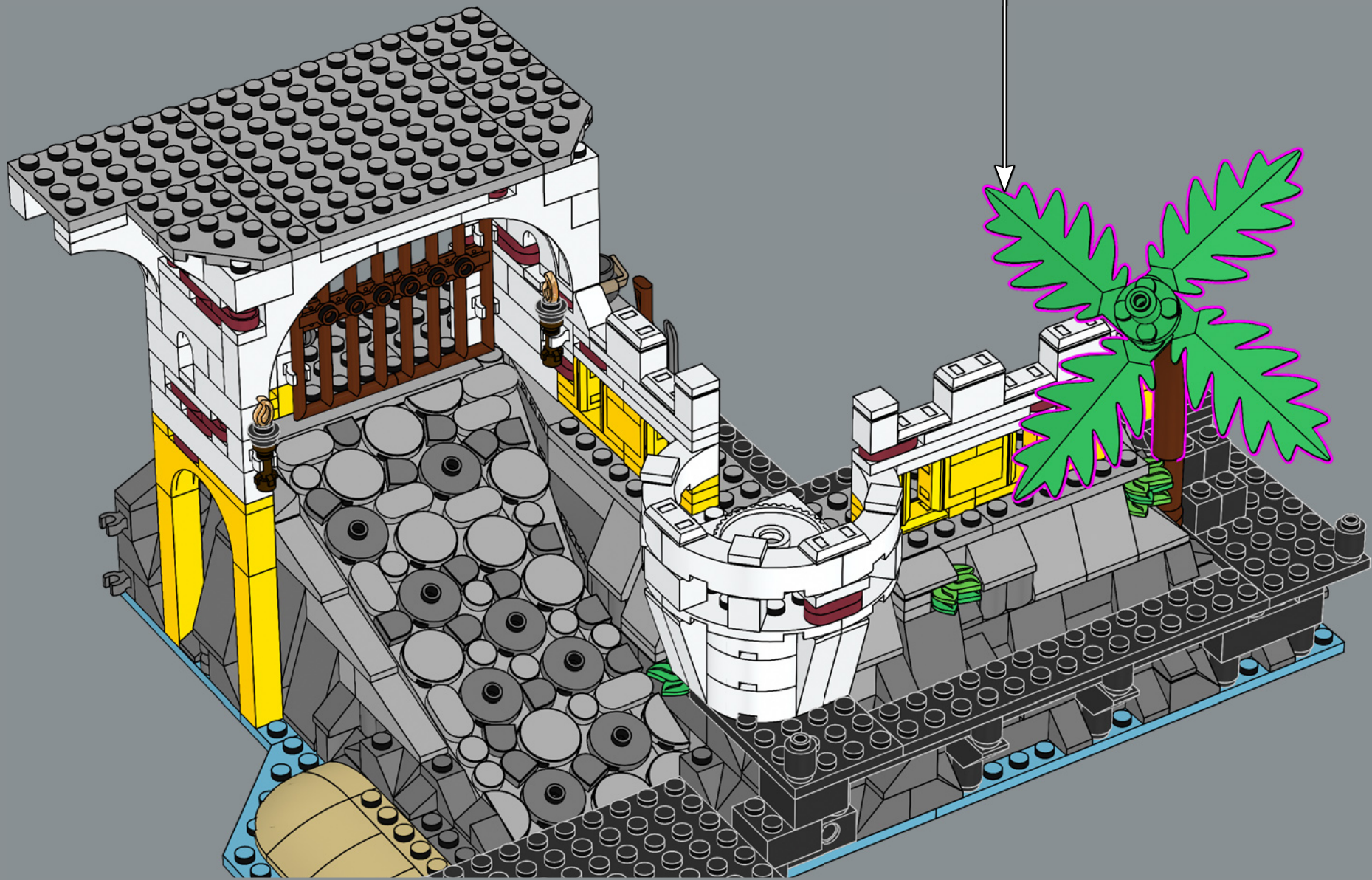



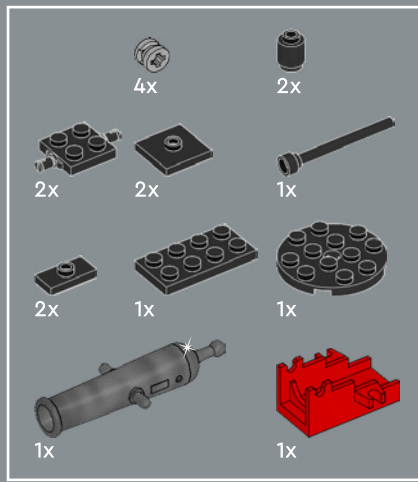

136

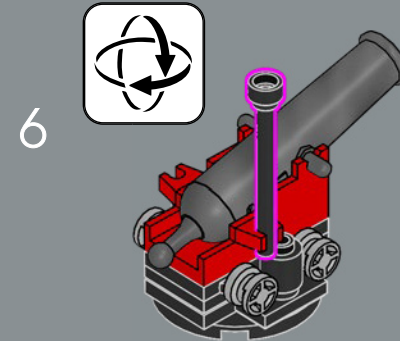
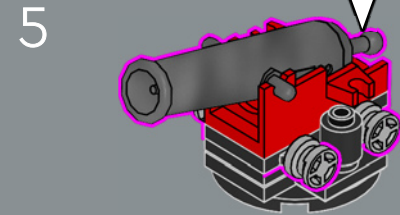
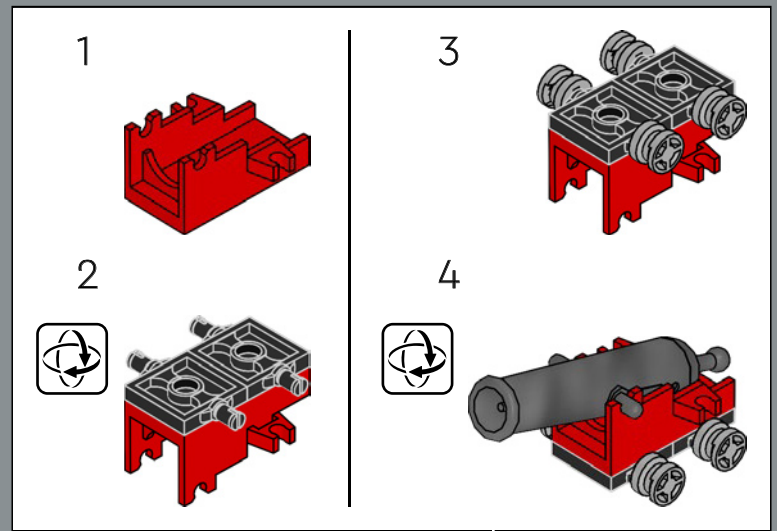
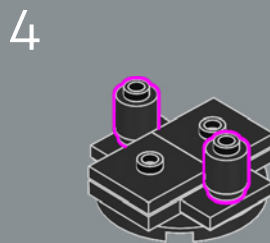
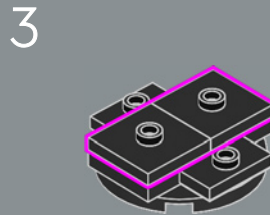
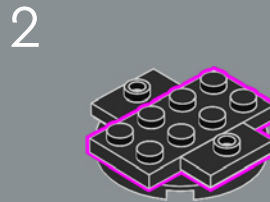
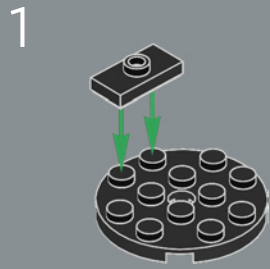

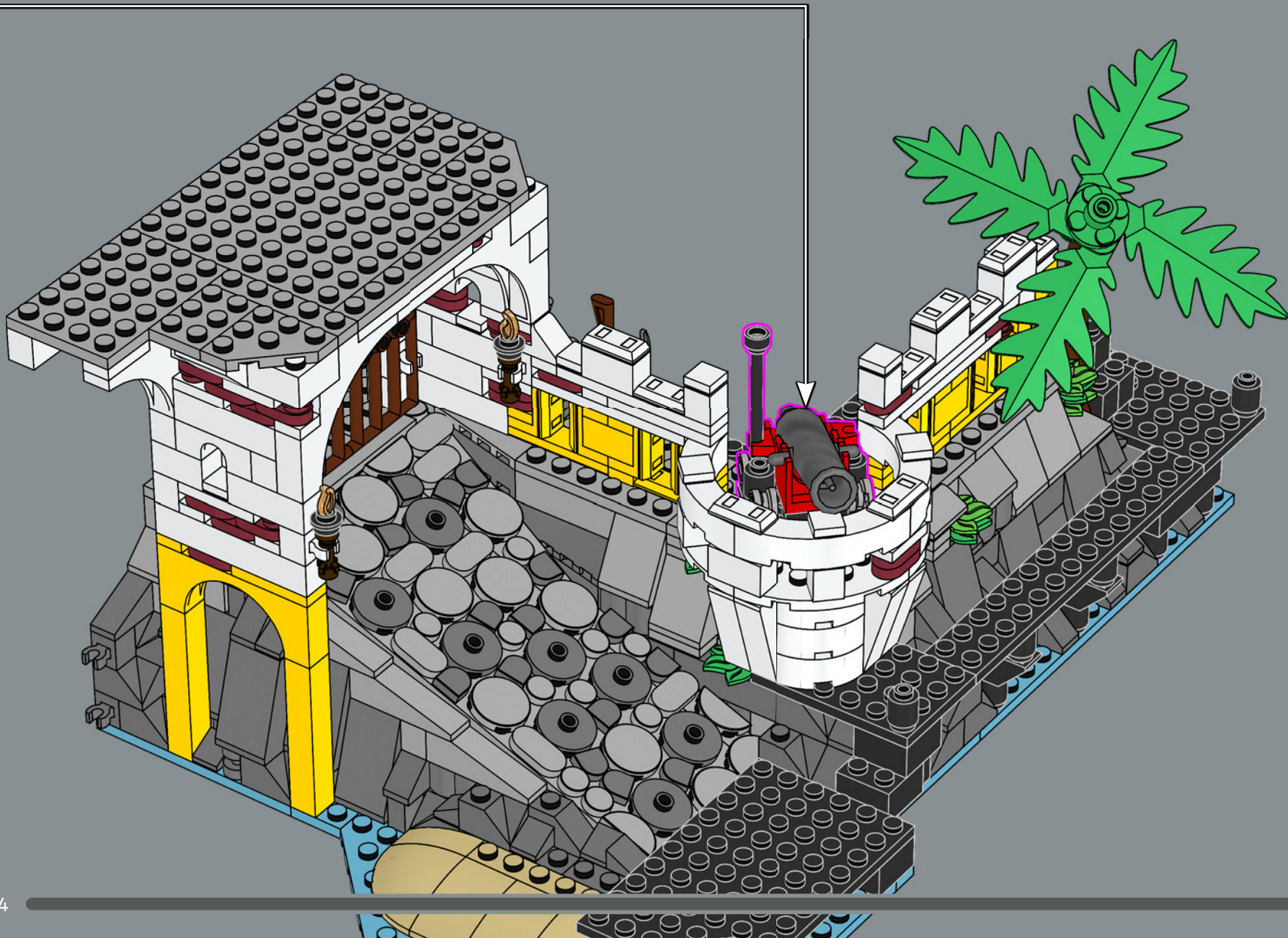

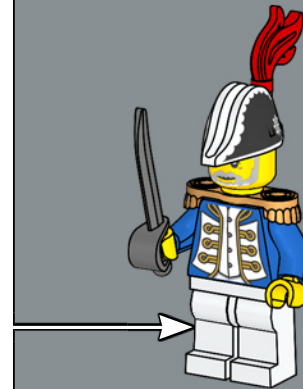
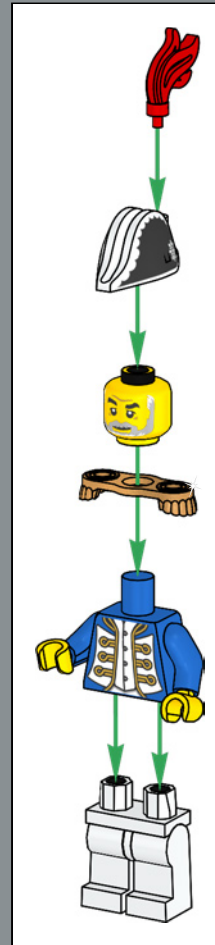



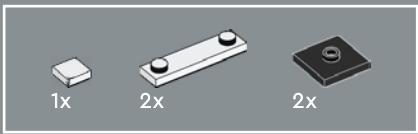

137

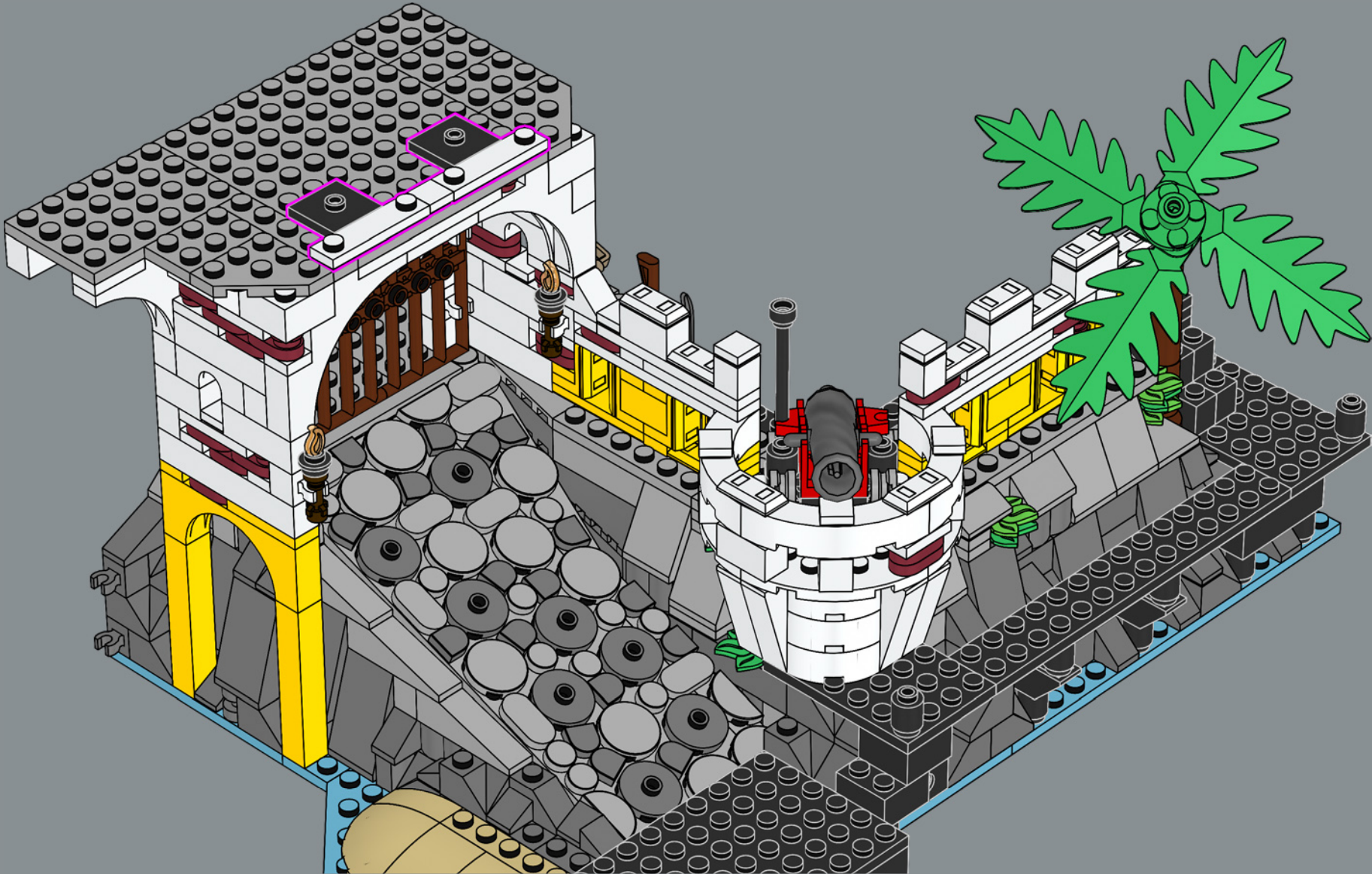

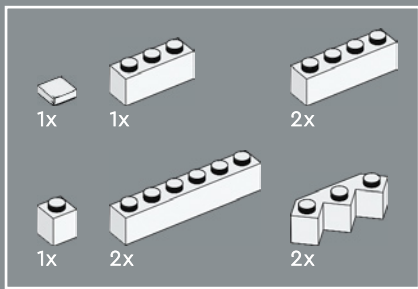

138





1x 5x 1x



139





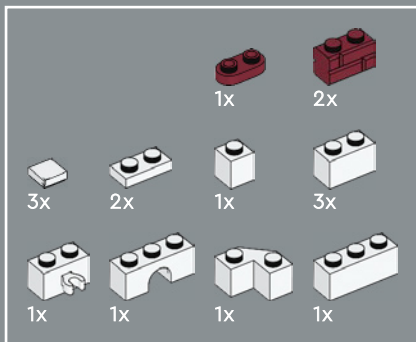

140

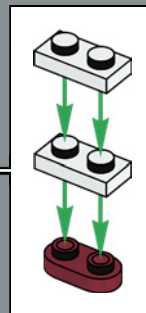

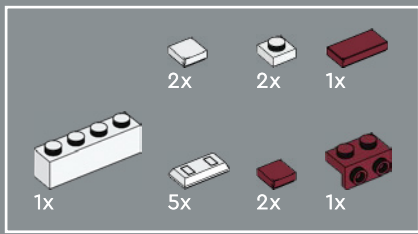

141

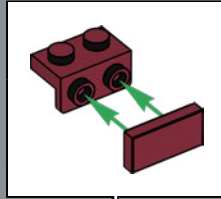



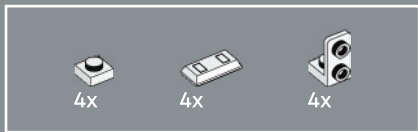

142

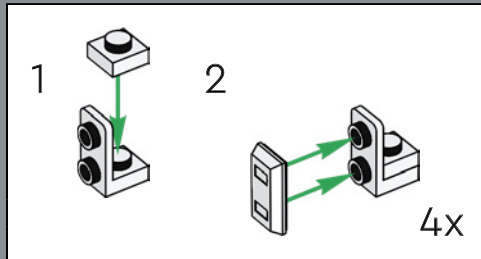





143

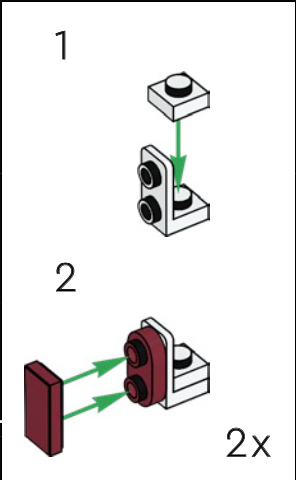

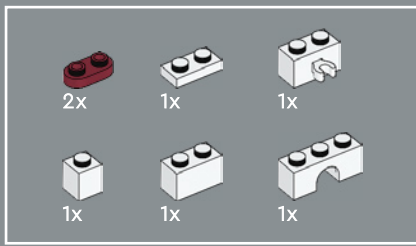

144

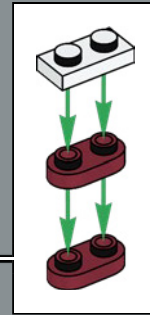



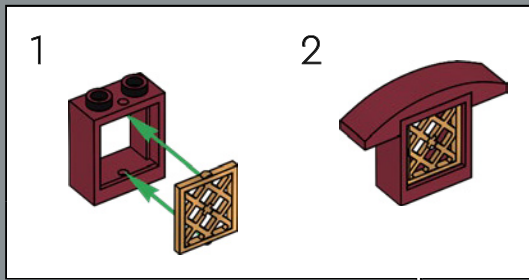
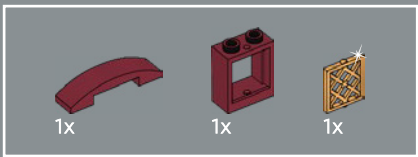

145





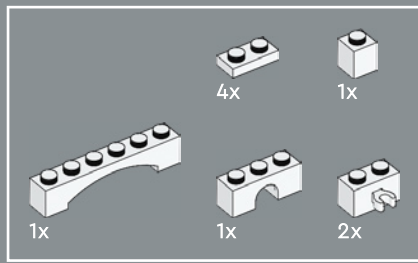

146

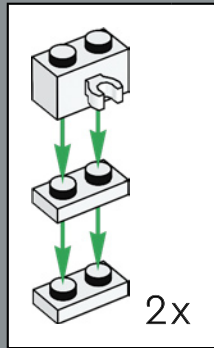

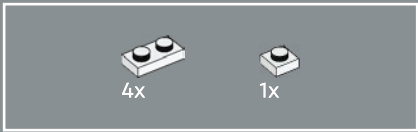

147





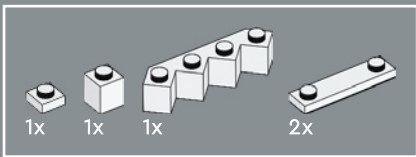

148

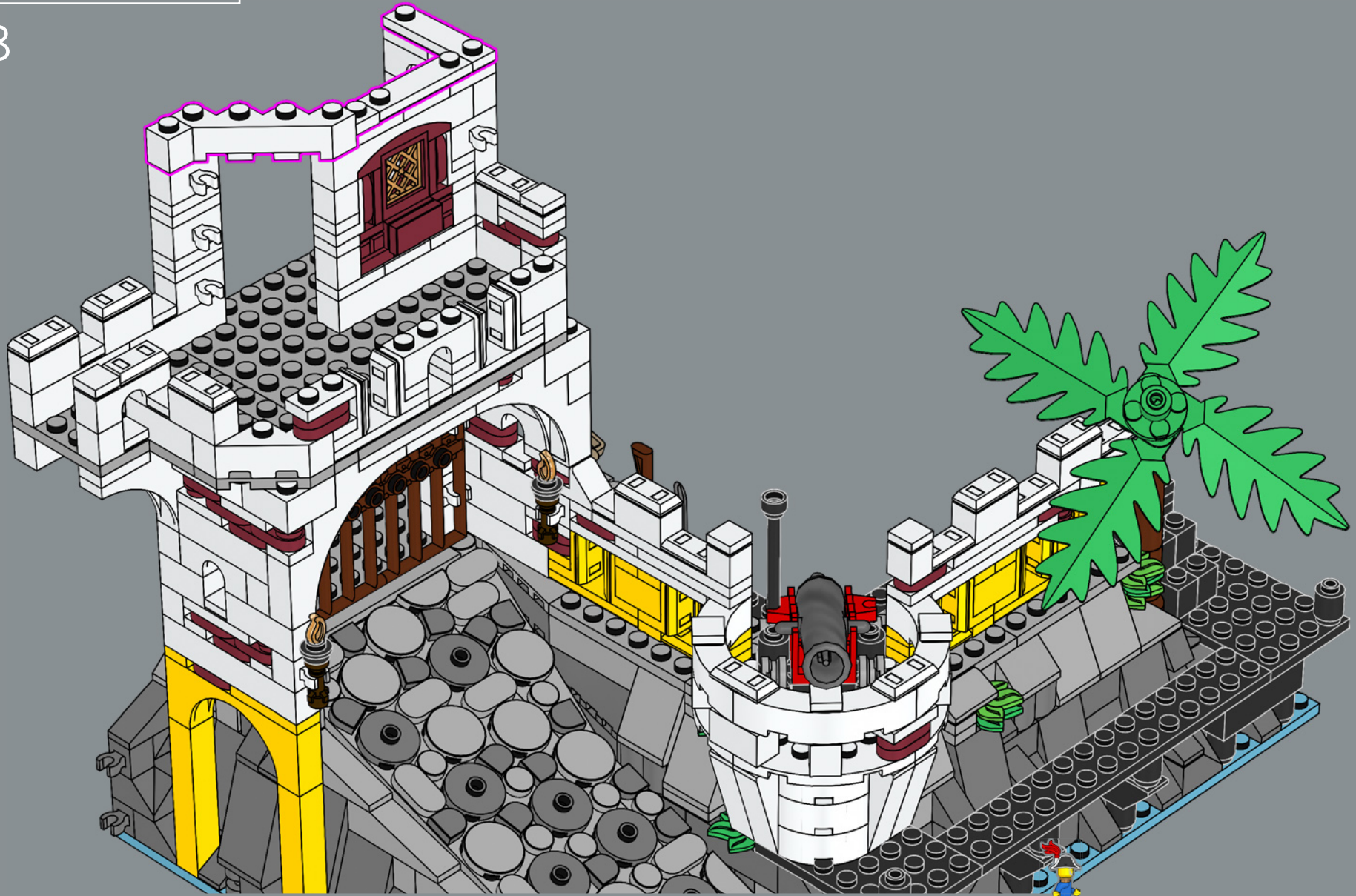

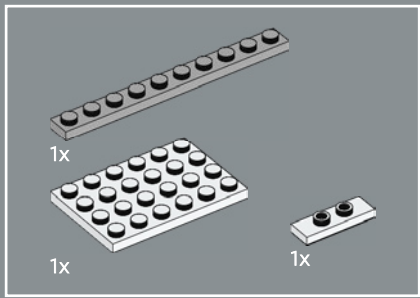

149

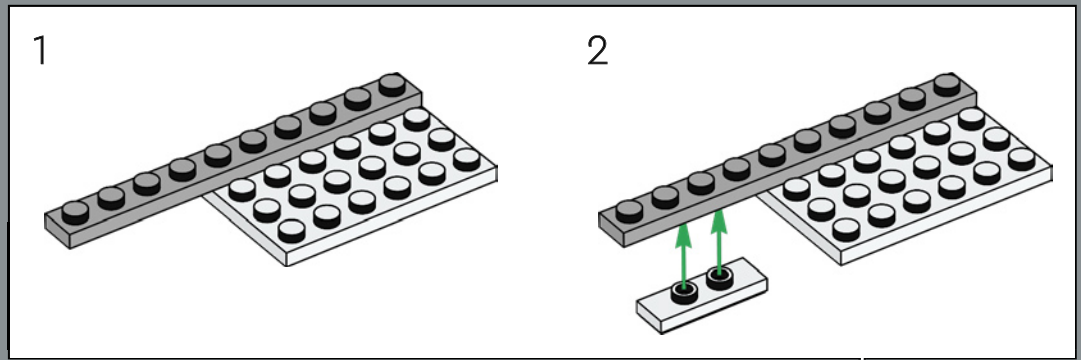



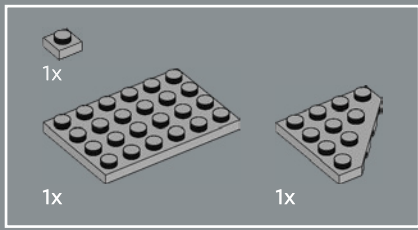

150



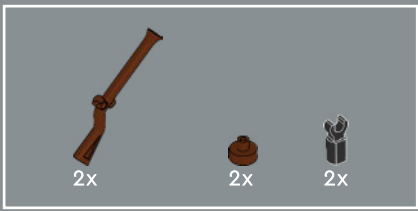

151

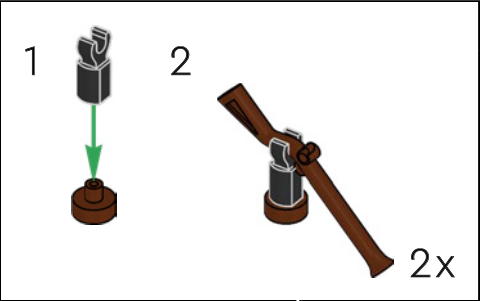



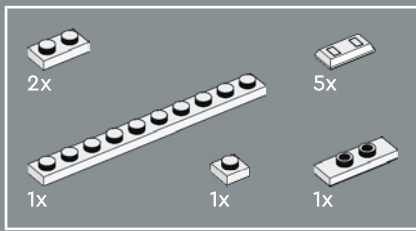

152

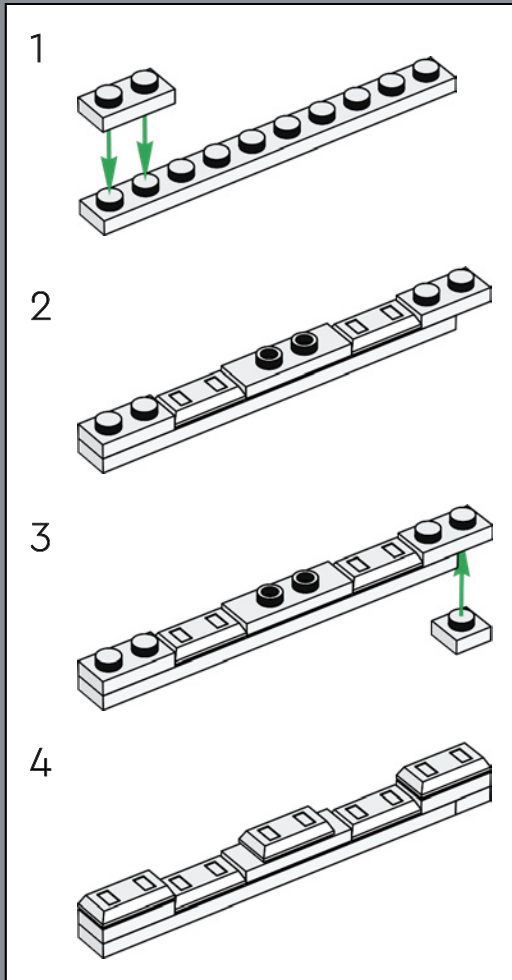

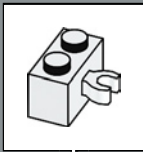
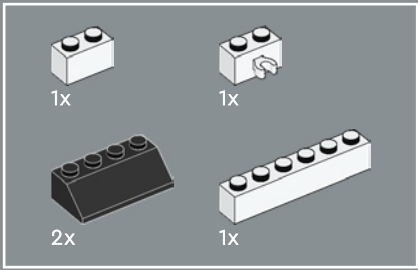

153





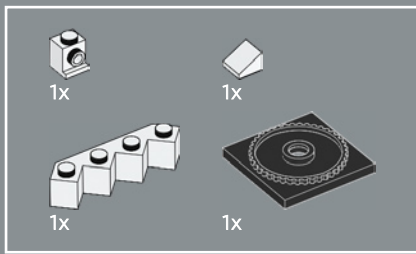

154



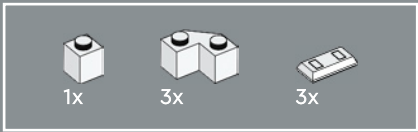

155







156



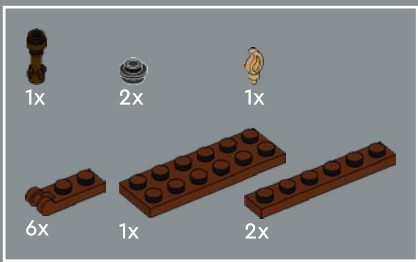

157

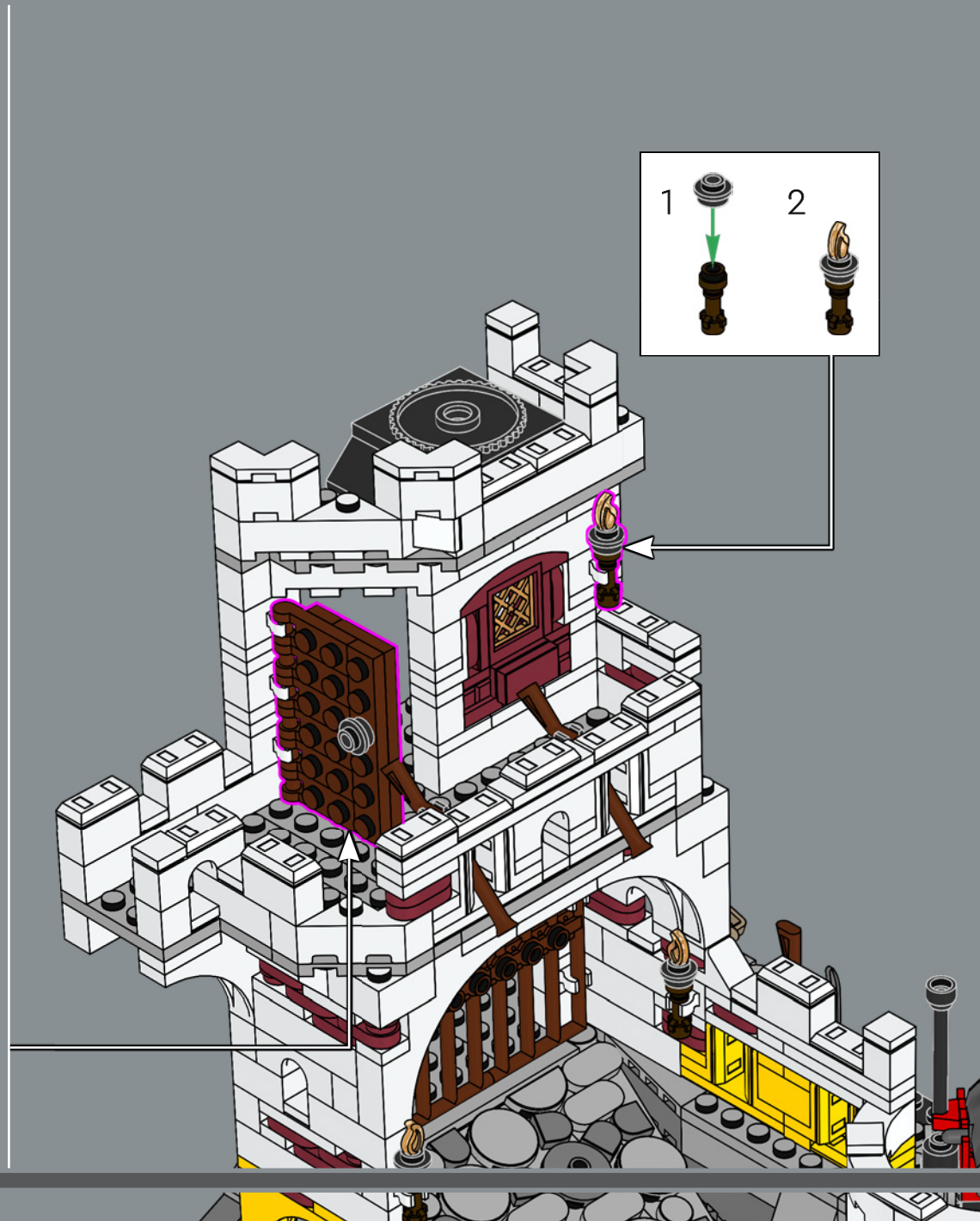
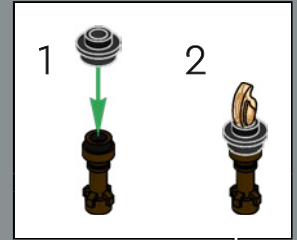
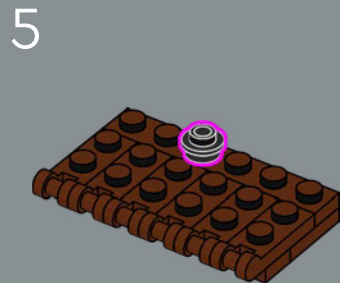
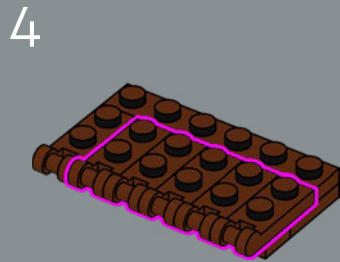
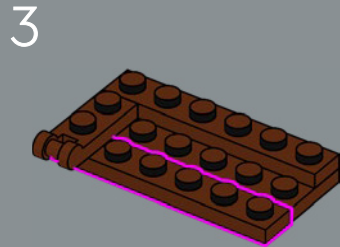
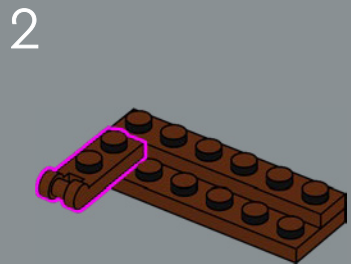
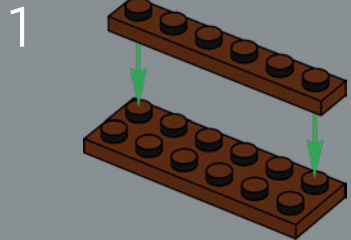





Im Büro des Gouverneurs befinden sich seine kostbarsten Schätze und wichtige Dokumente.

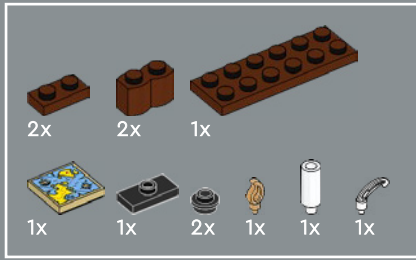

158

1

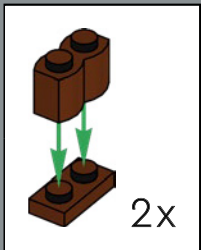
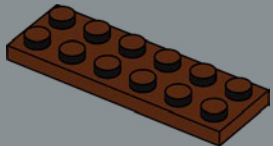

2x

2

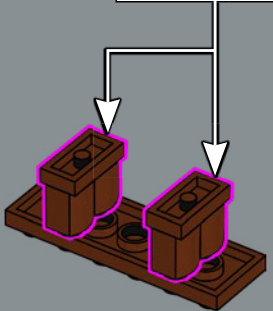

3



4

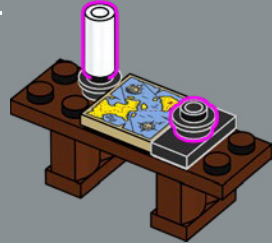

5



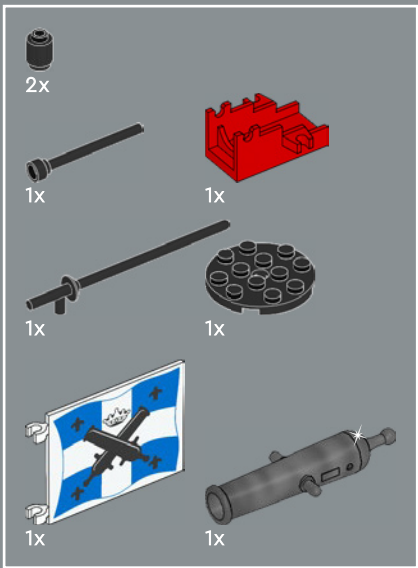

159

1



2

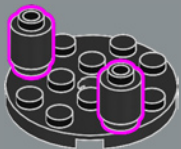

3

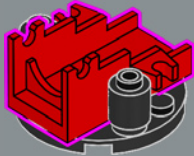

4

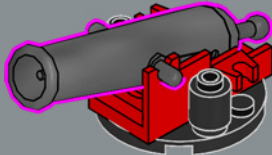

5

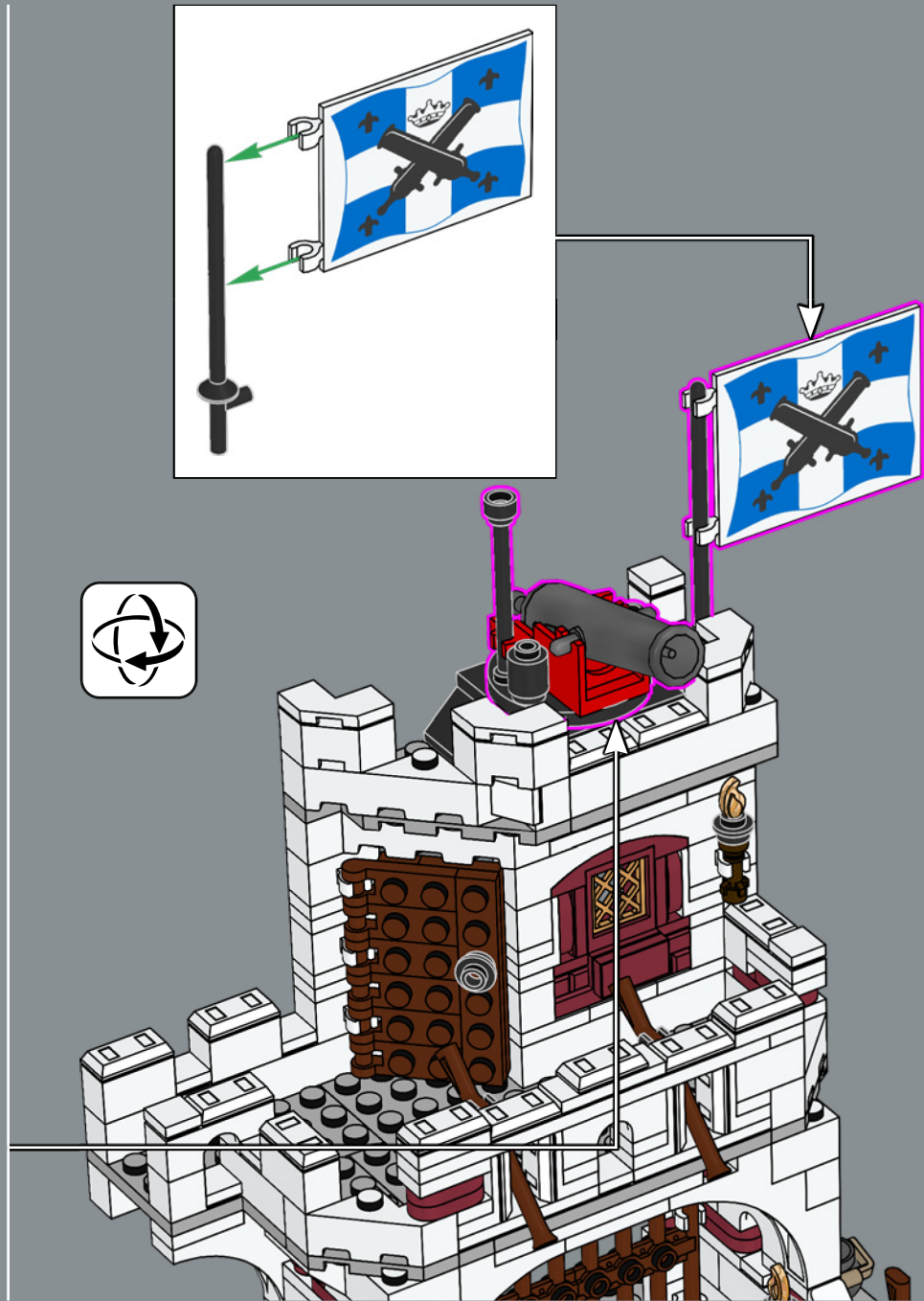
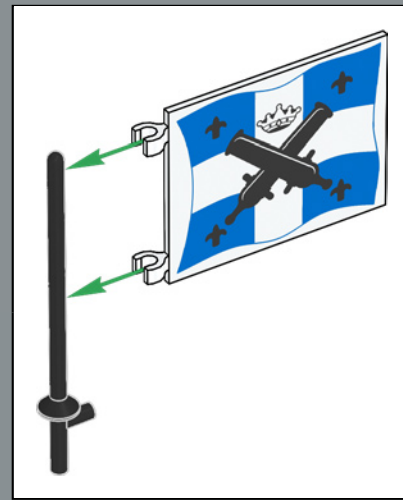
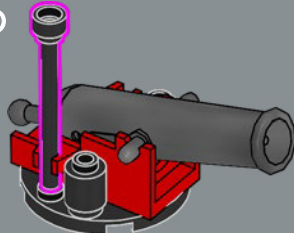







LEGO and the LEGO logo are trademarks of the LEGO Group.  
©2023 The LEGO Group.