

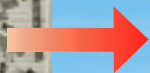

CITY

3367

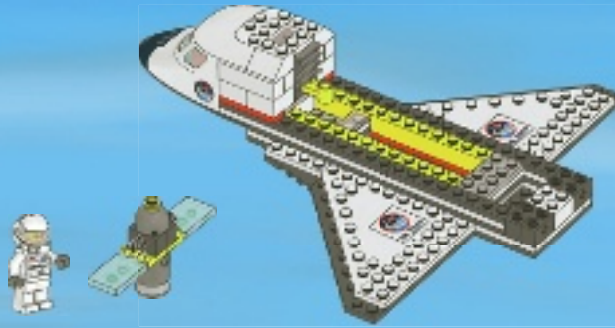



1

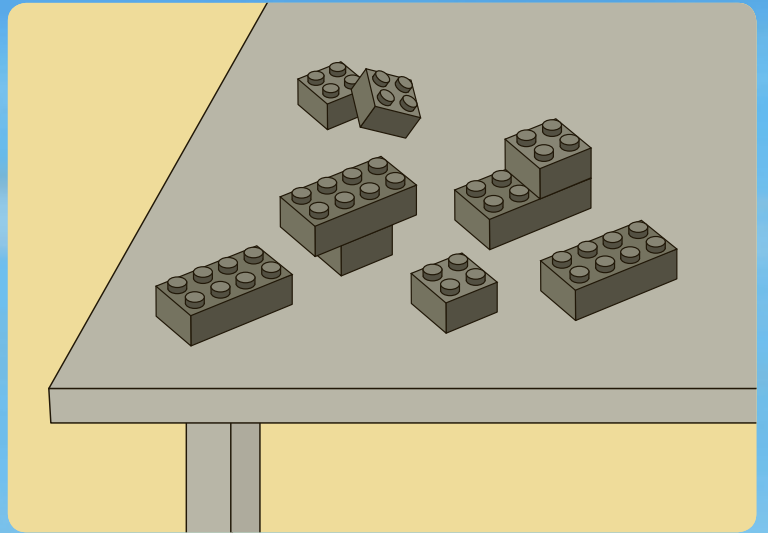
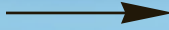
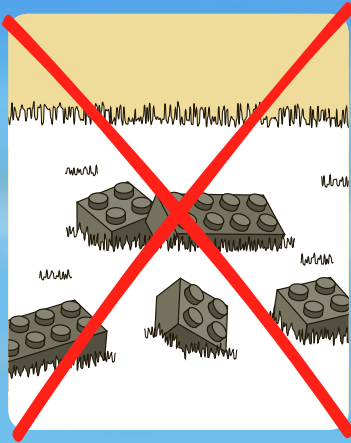

2



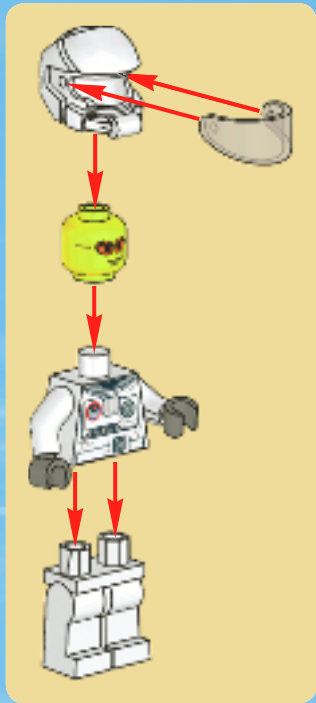
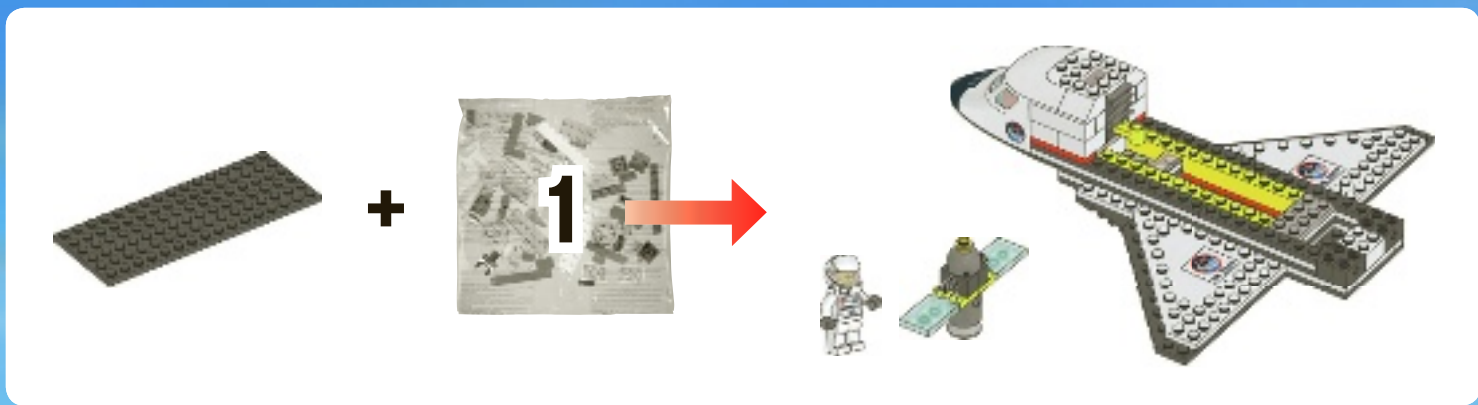

1



2



3

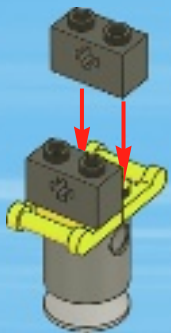

4

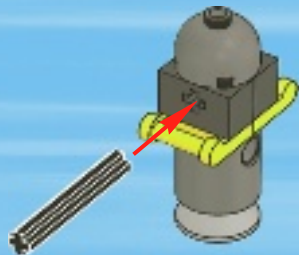

5

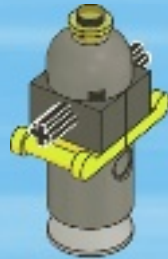

6



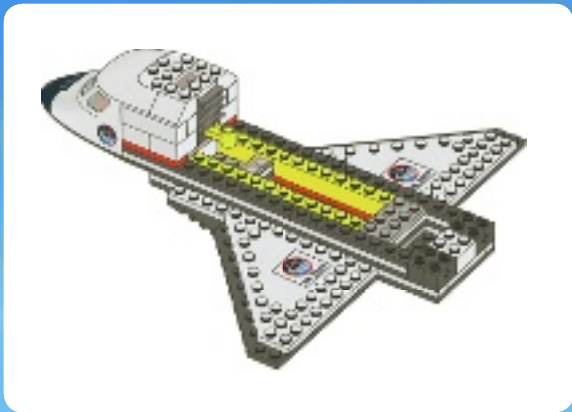

1



2



3



4

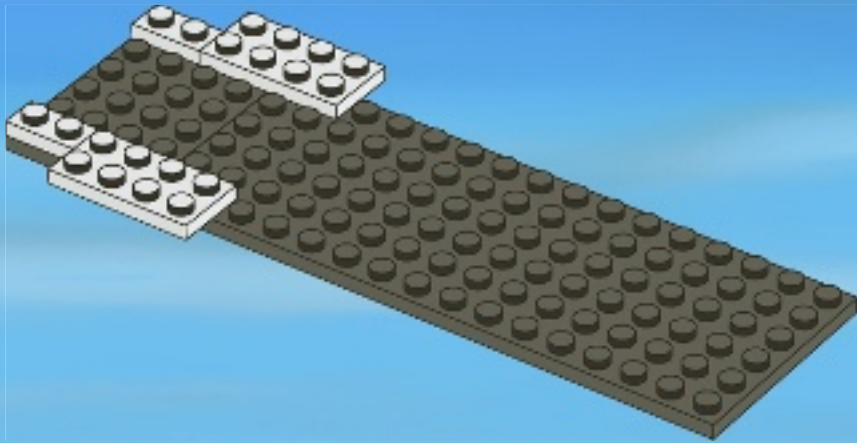

5

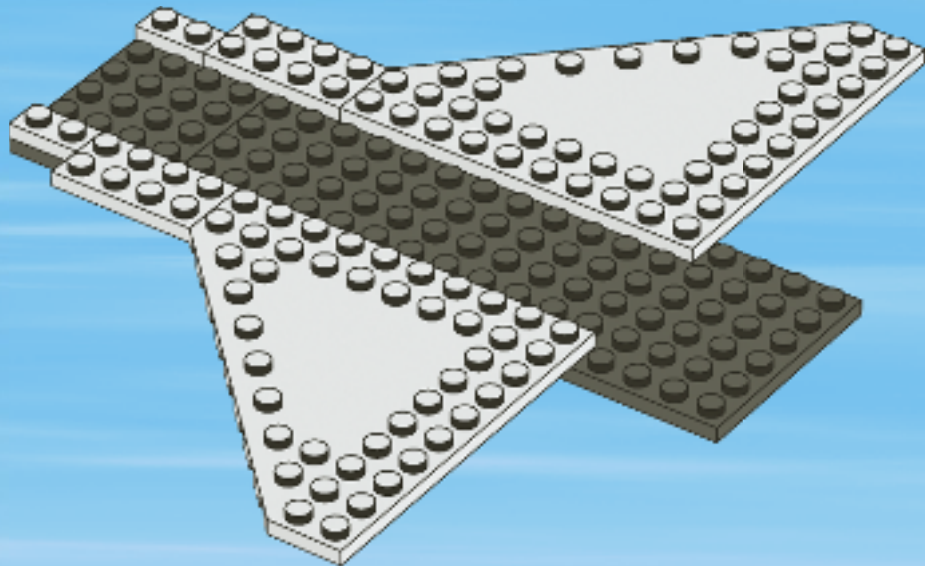

6

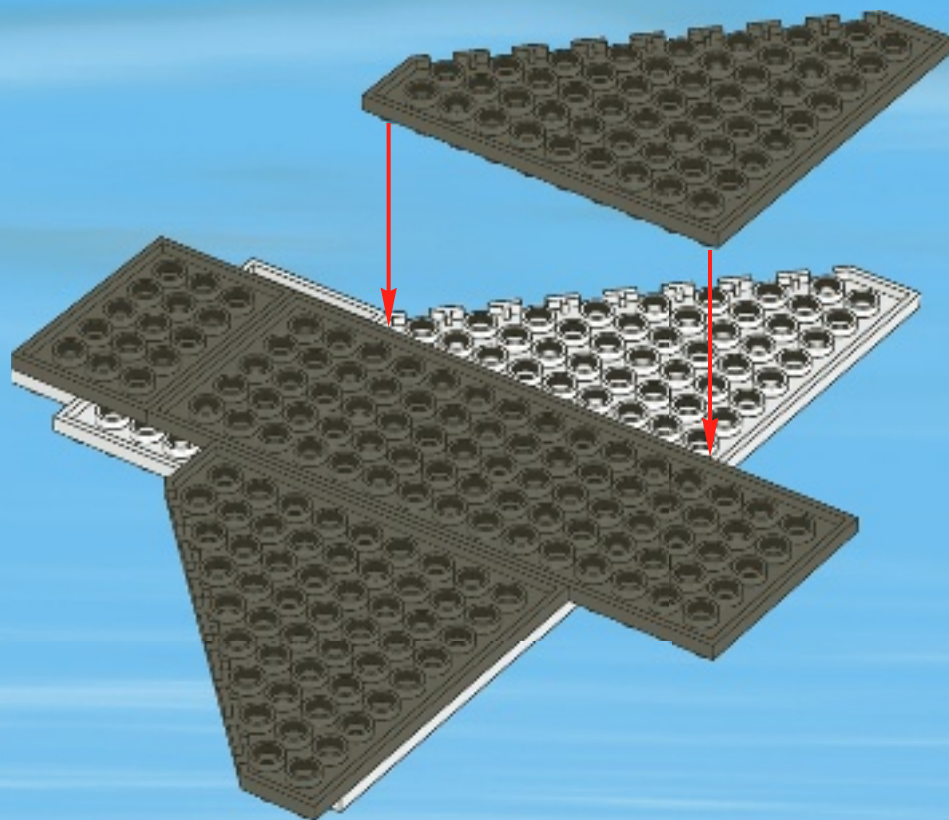

7

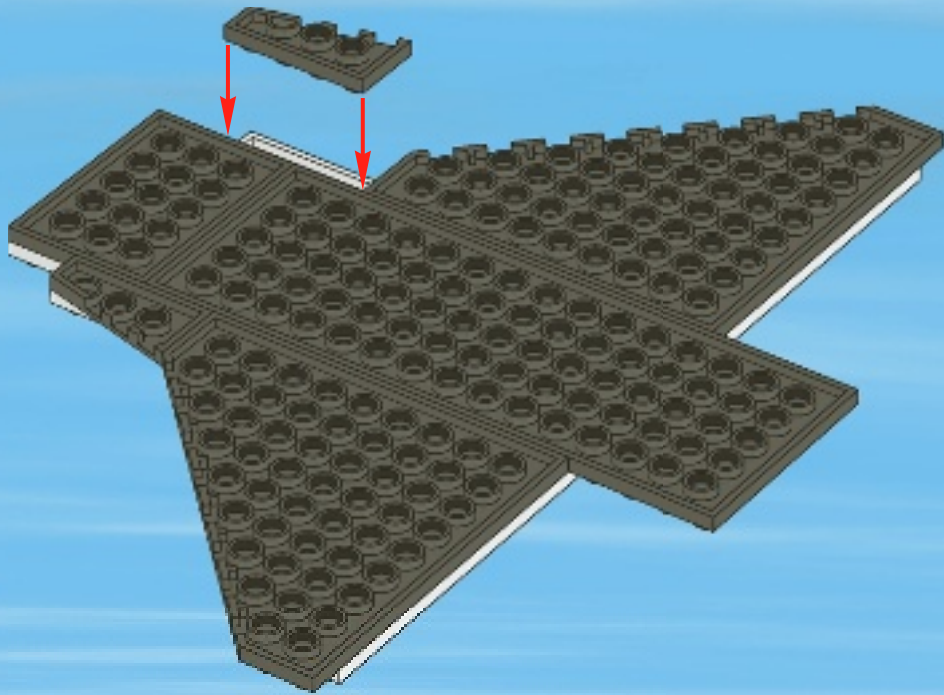



1

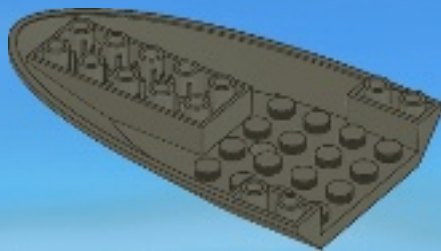

2

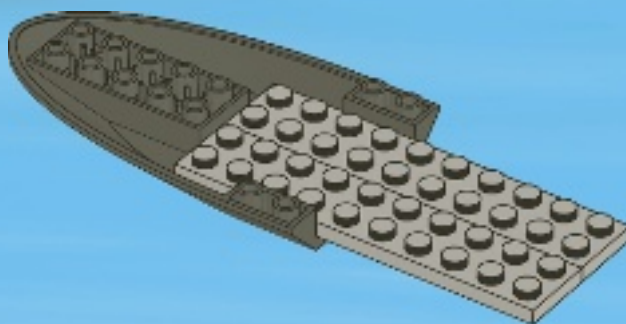

3

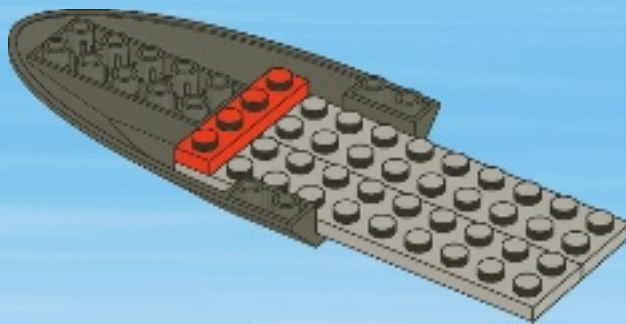

4

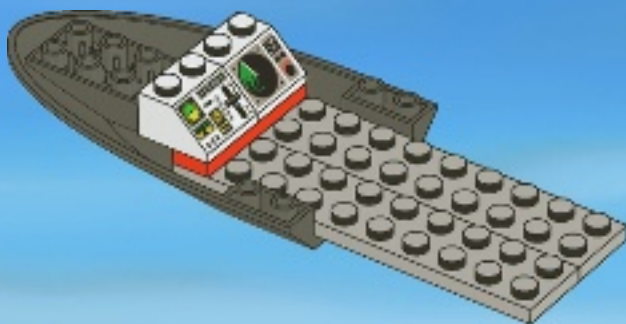

5

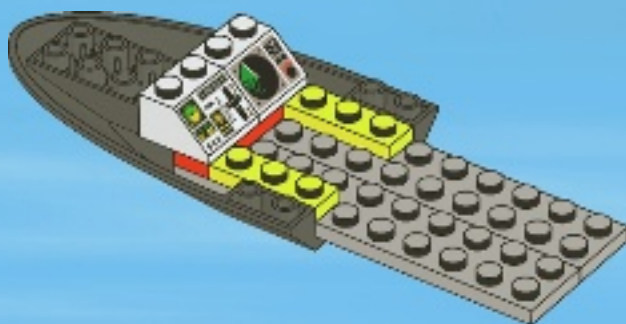

6

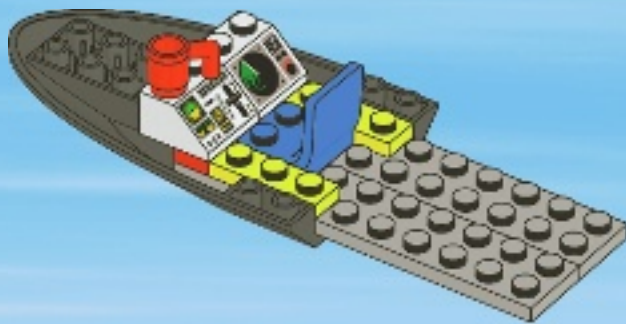

8

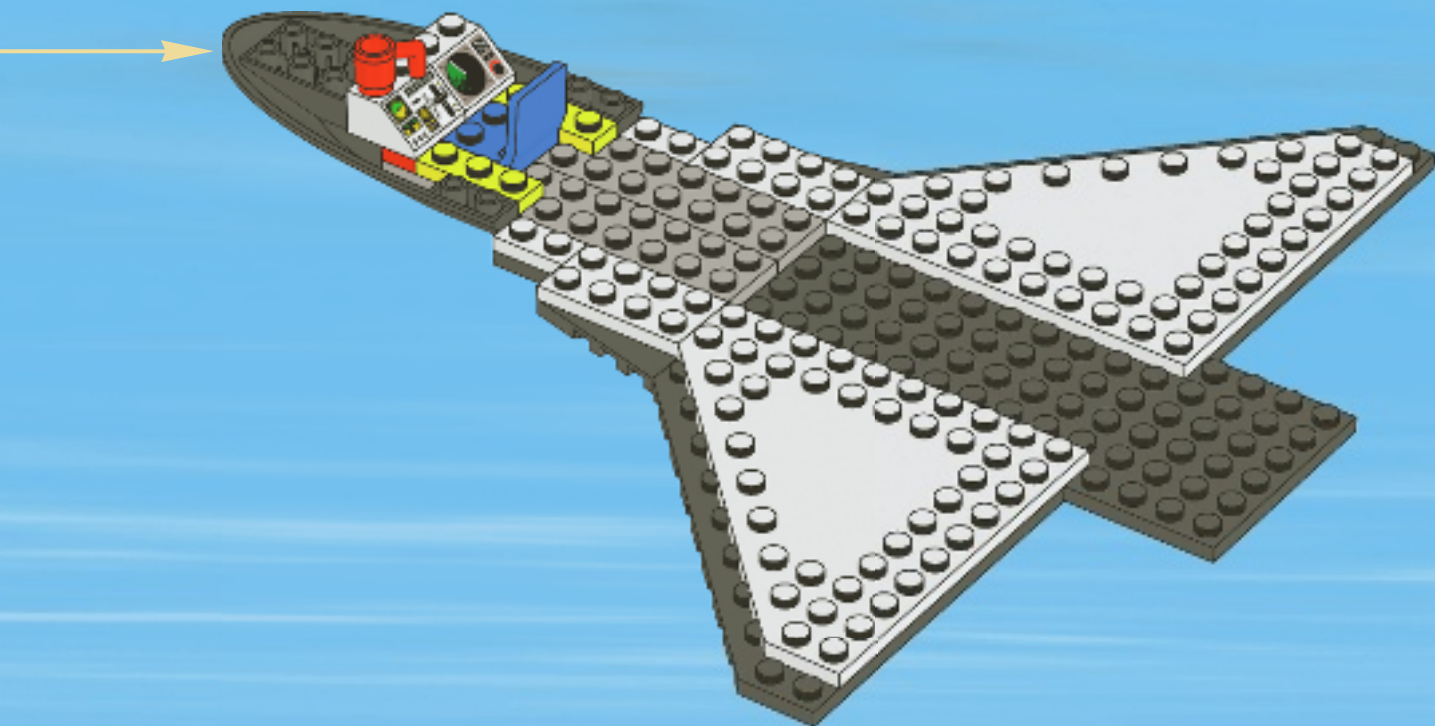

9

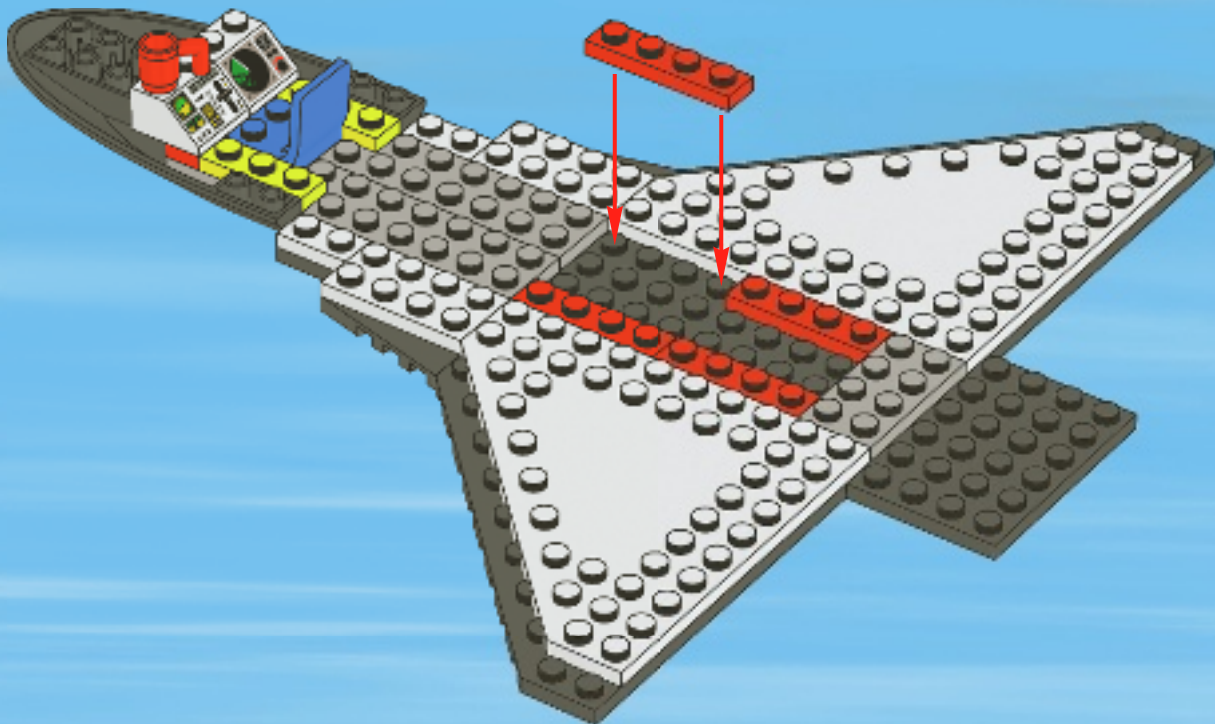

10

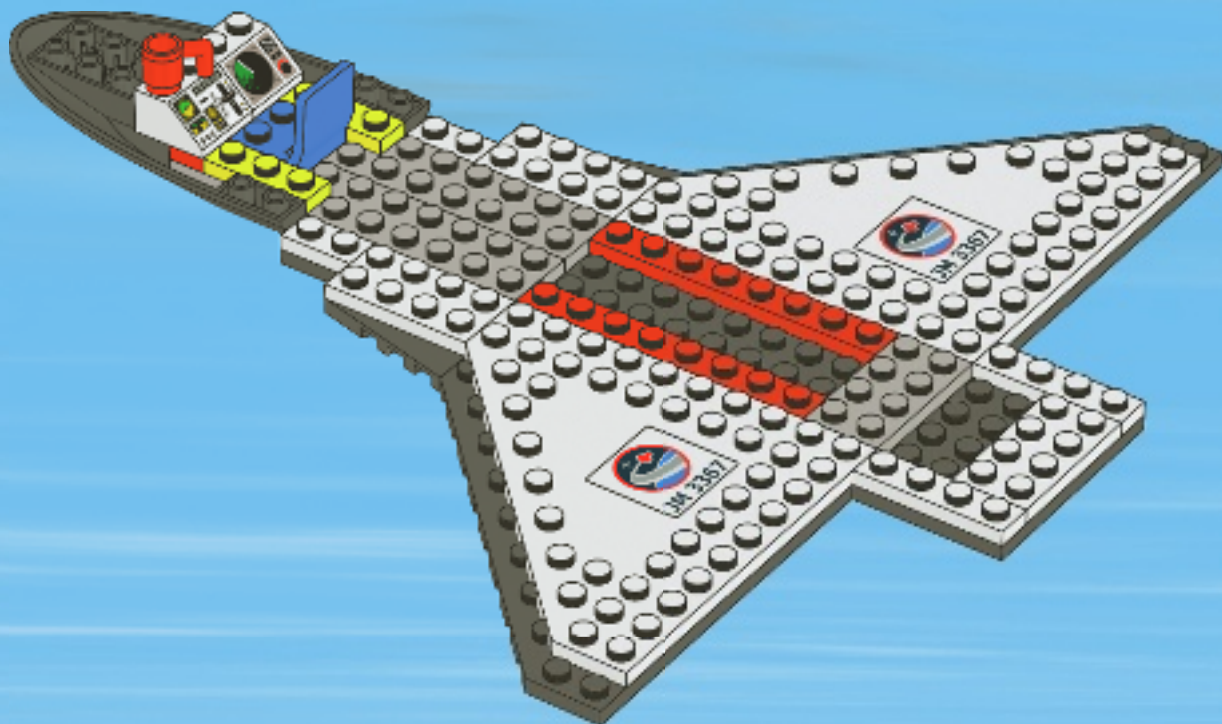

11

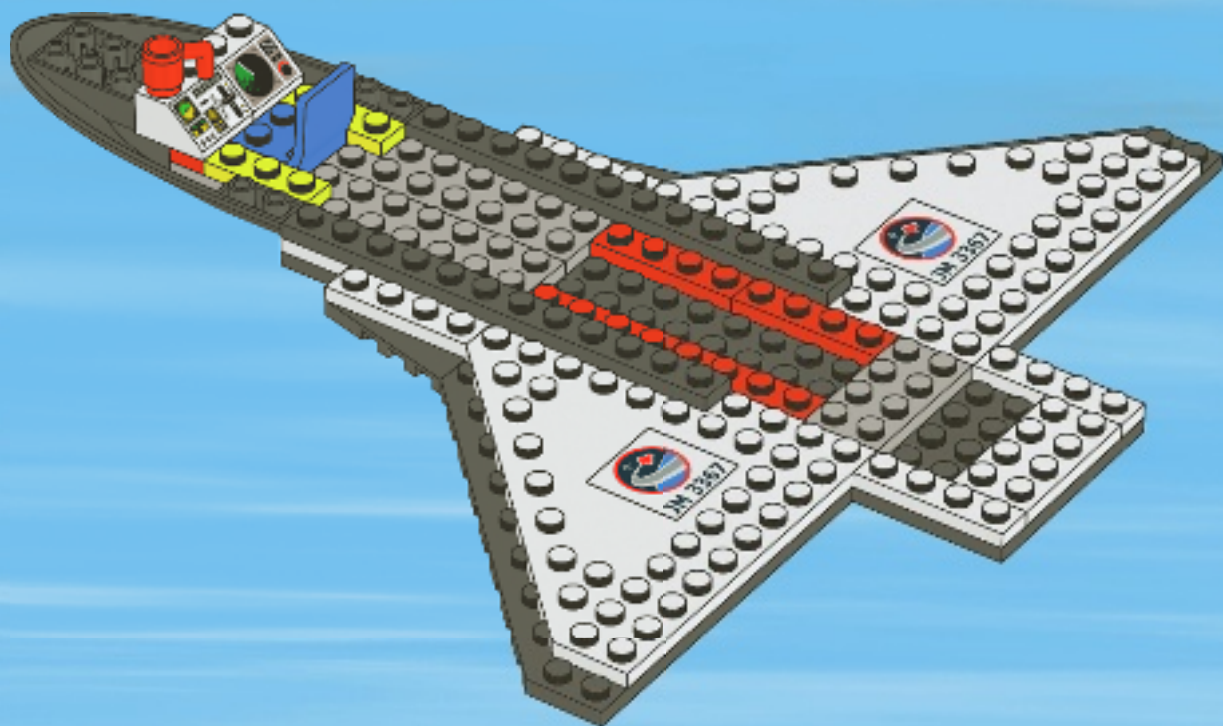

12

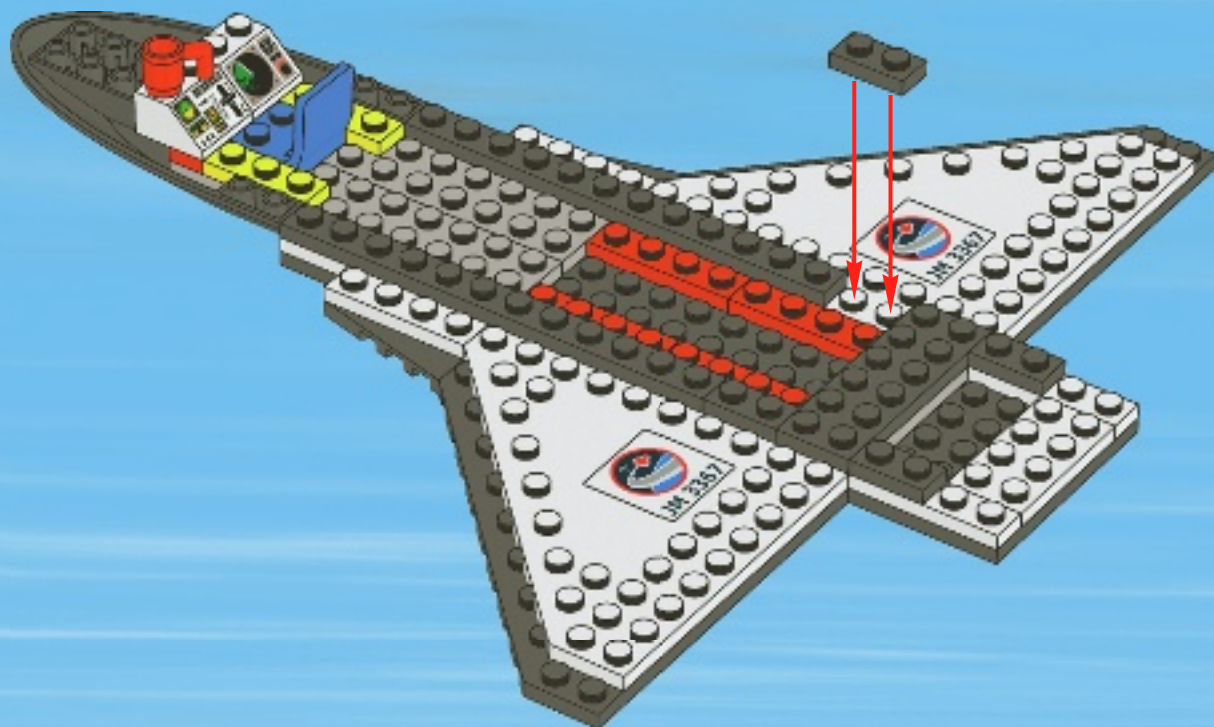

13

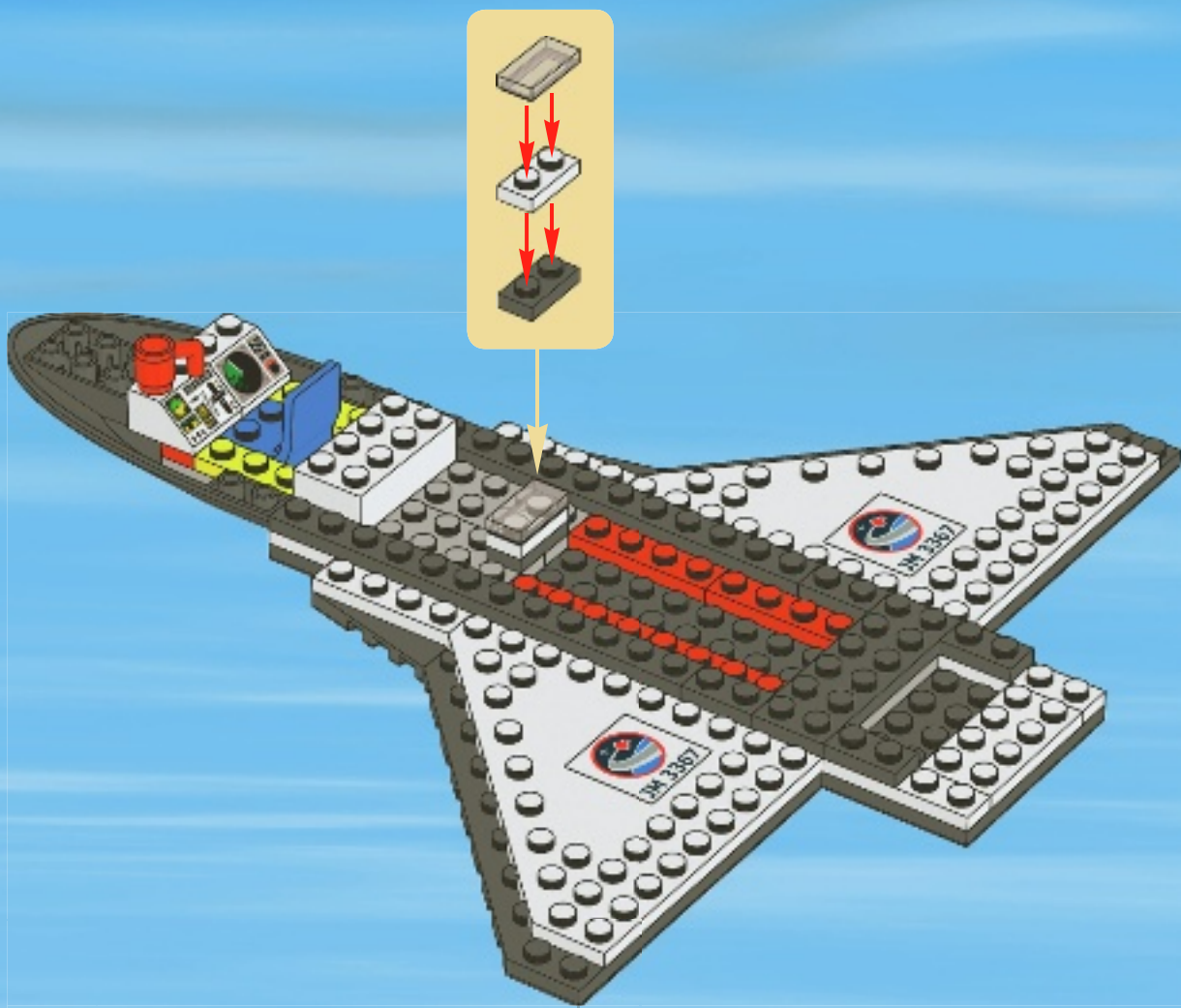

14

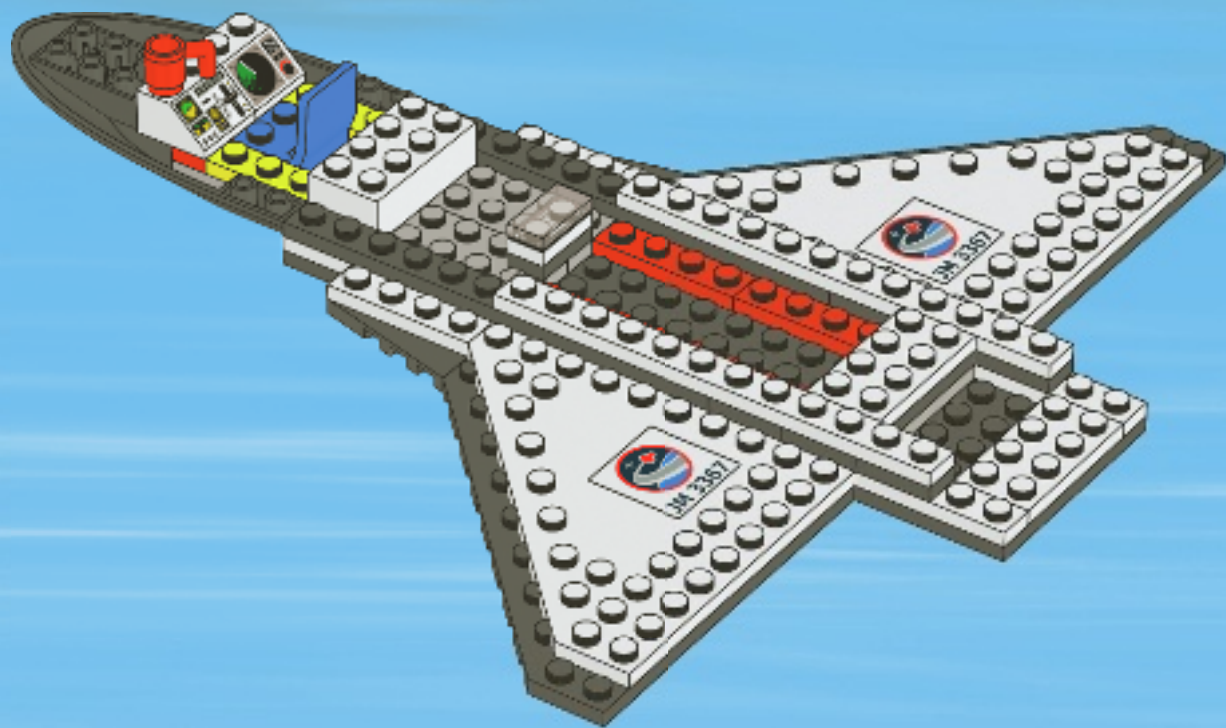

15

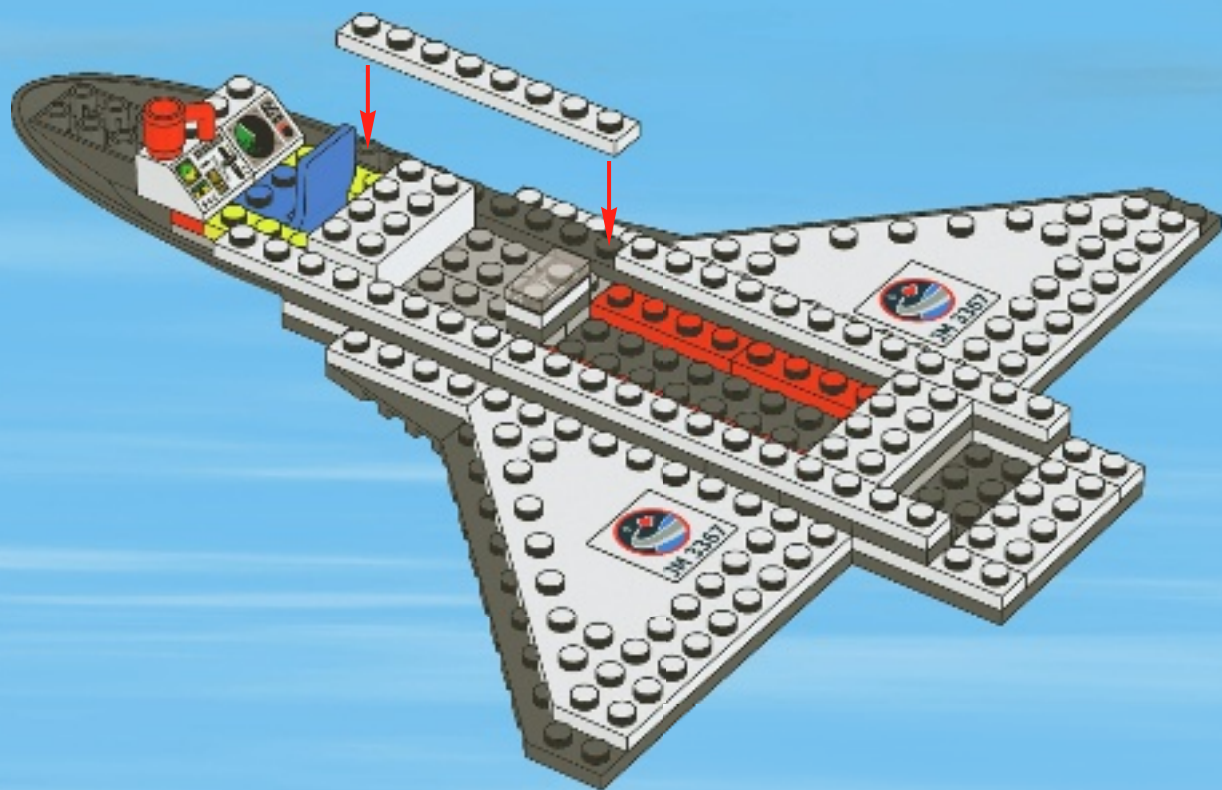

16

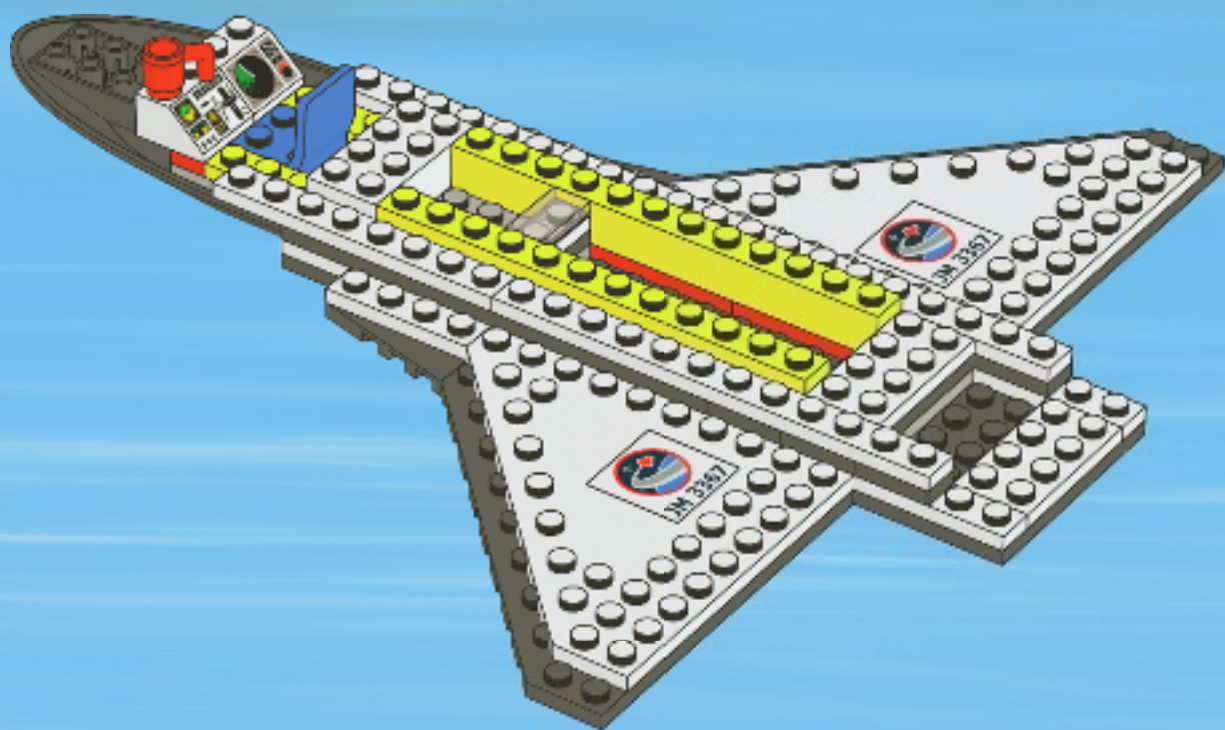

17

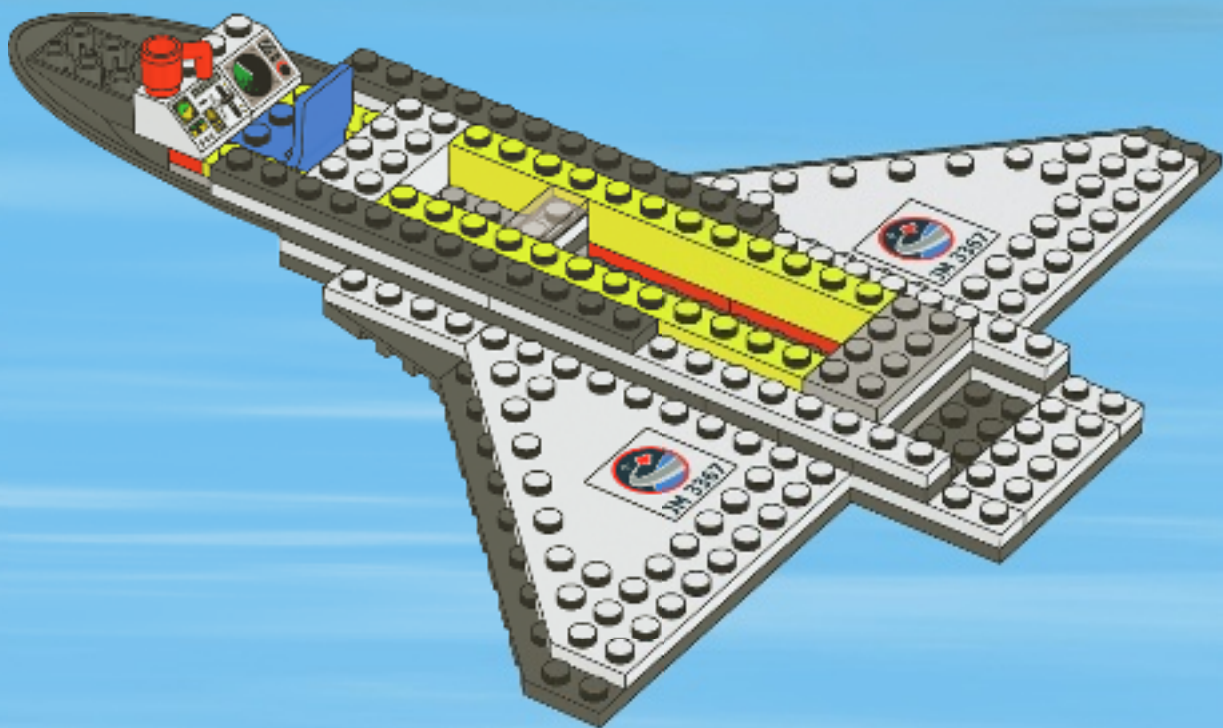

18

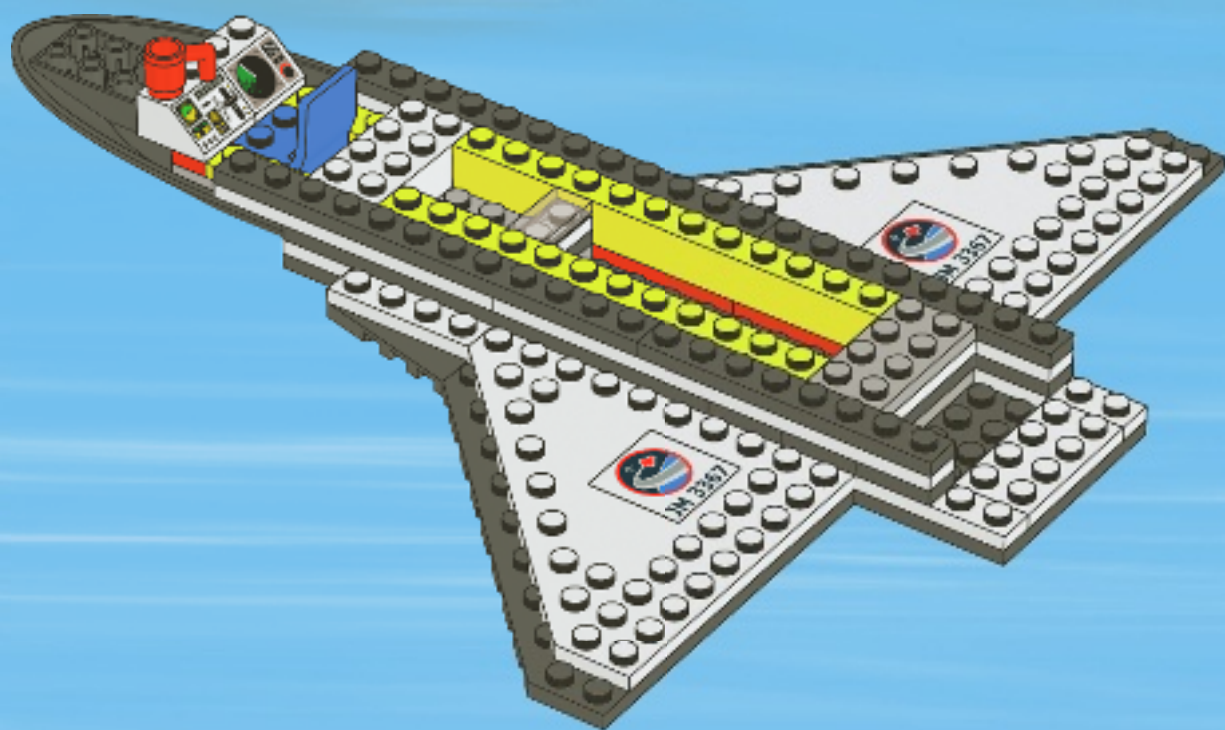

19

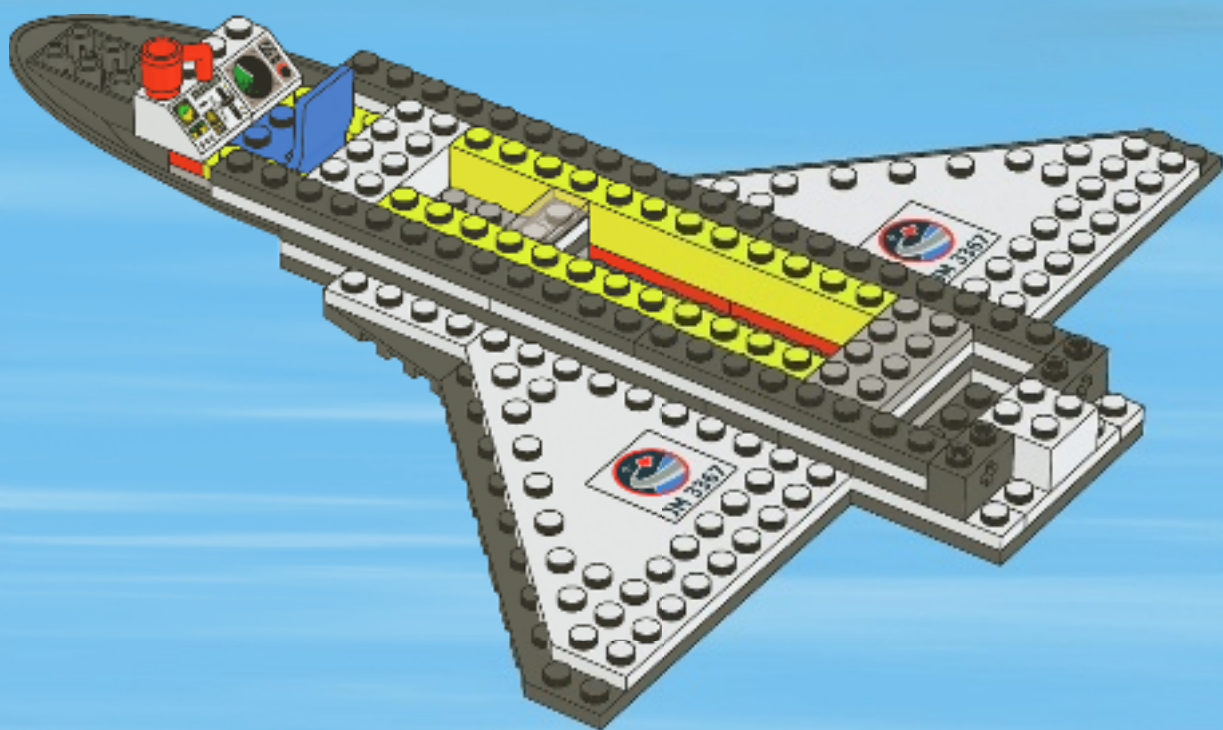

20

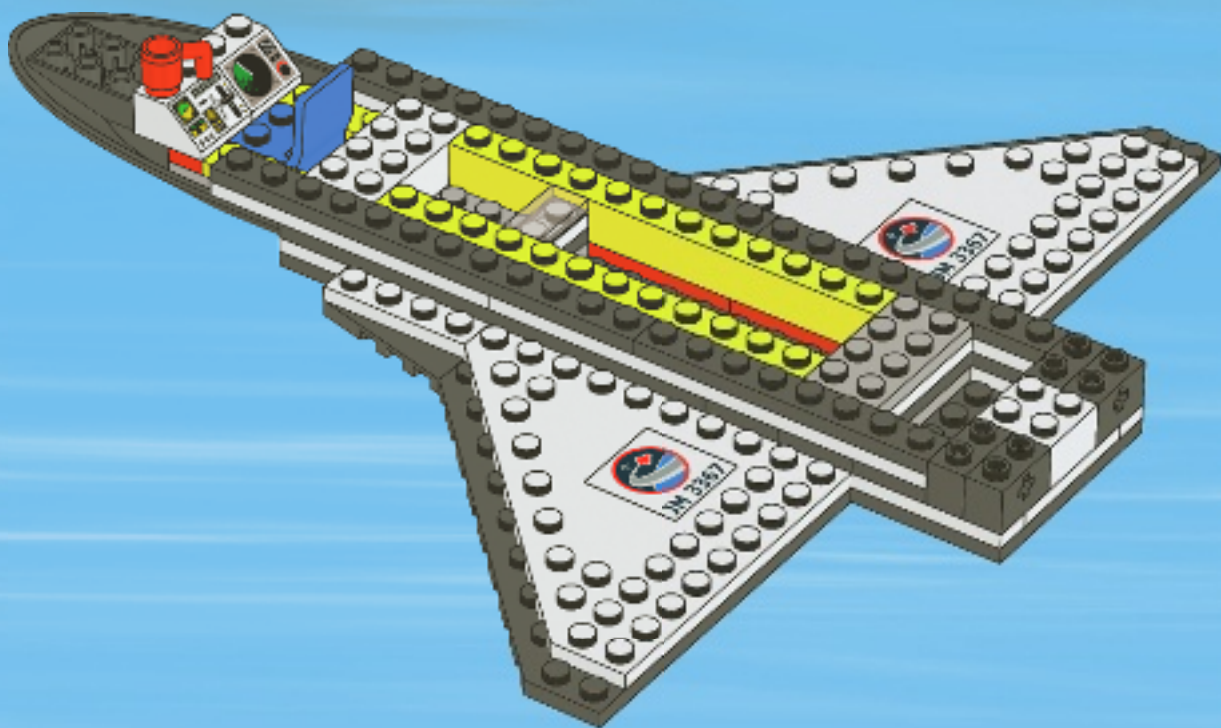

21

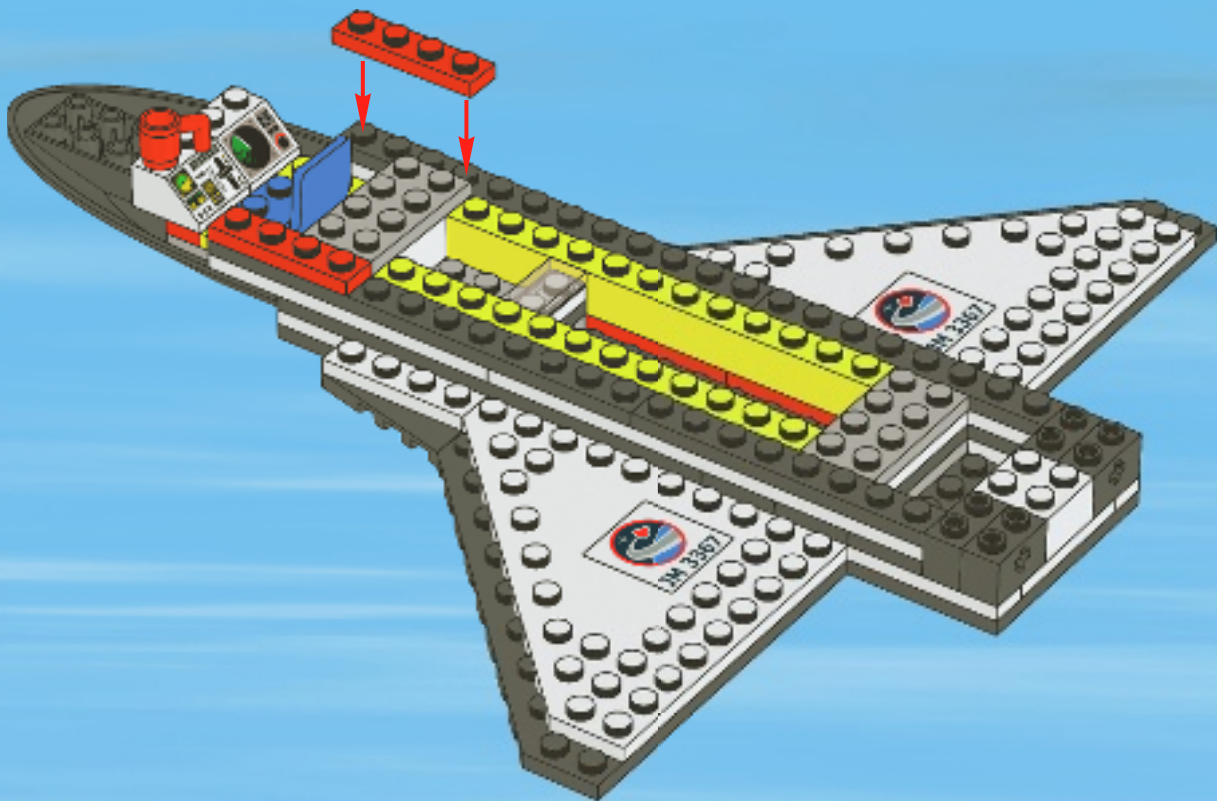

22

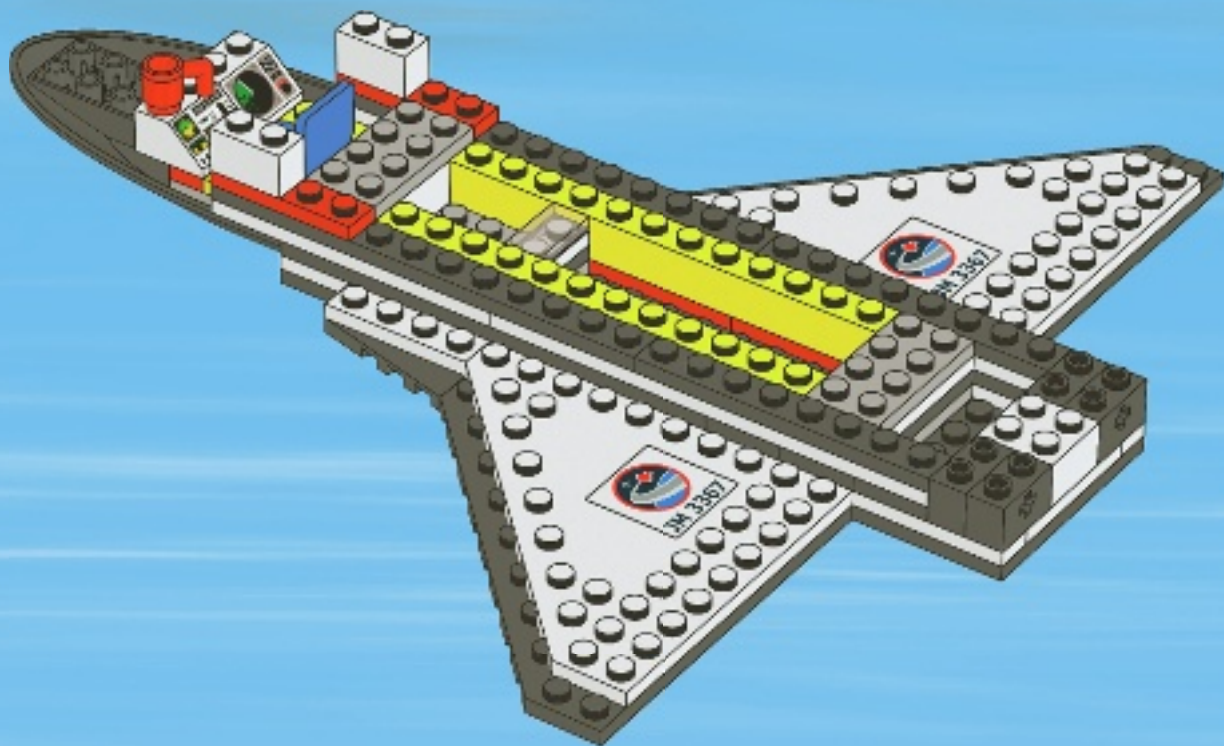

23

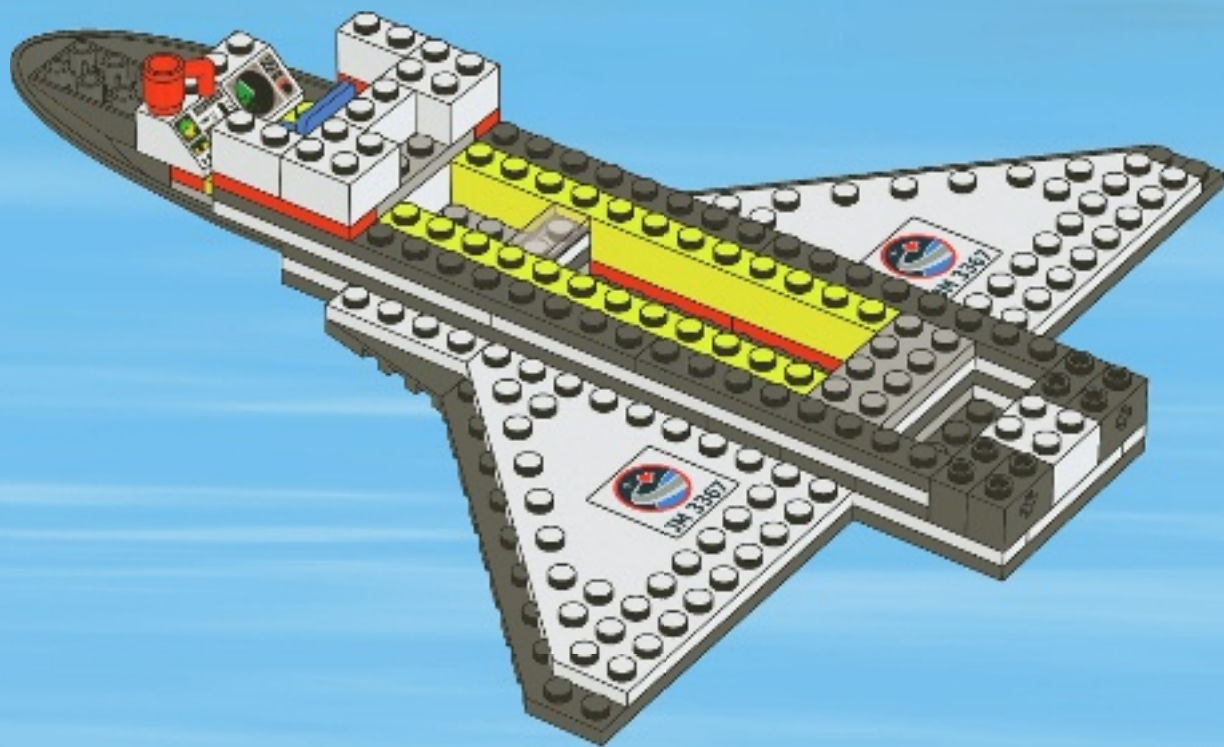

1

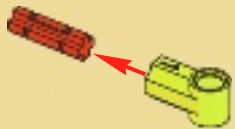

2

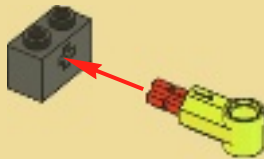

3



24

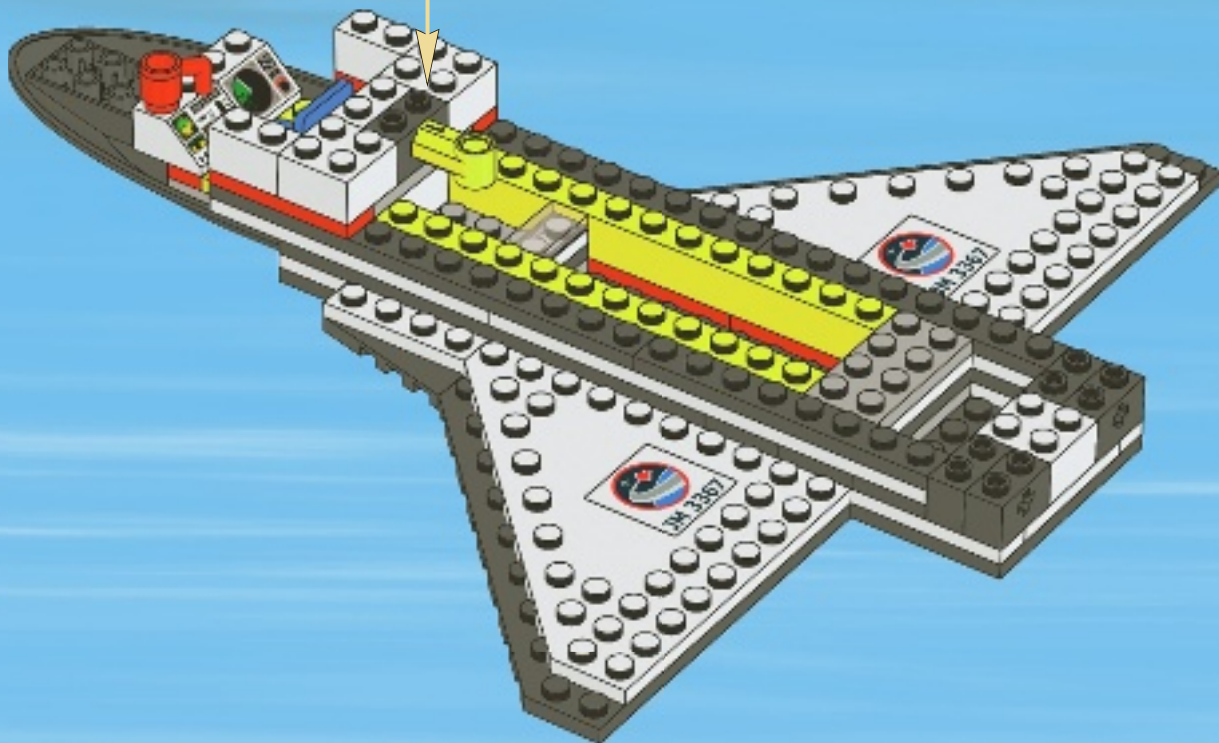

25

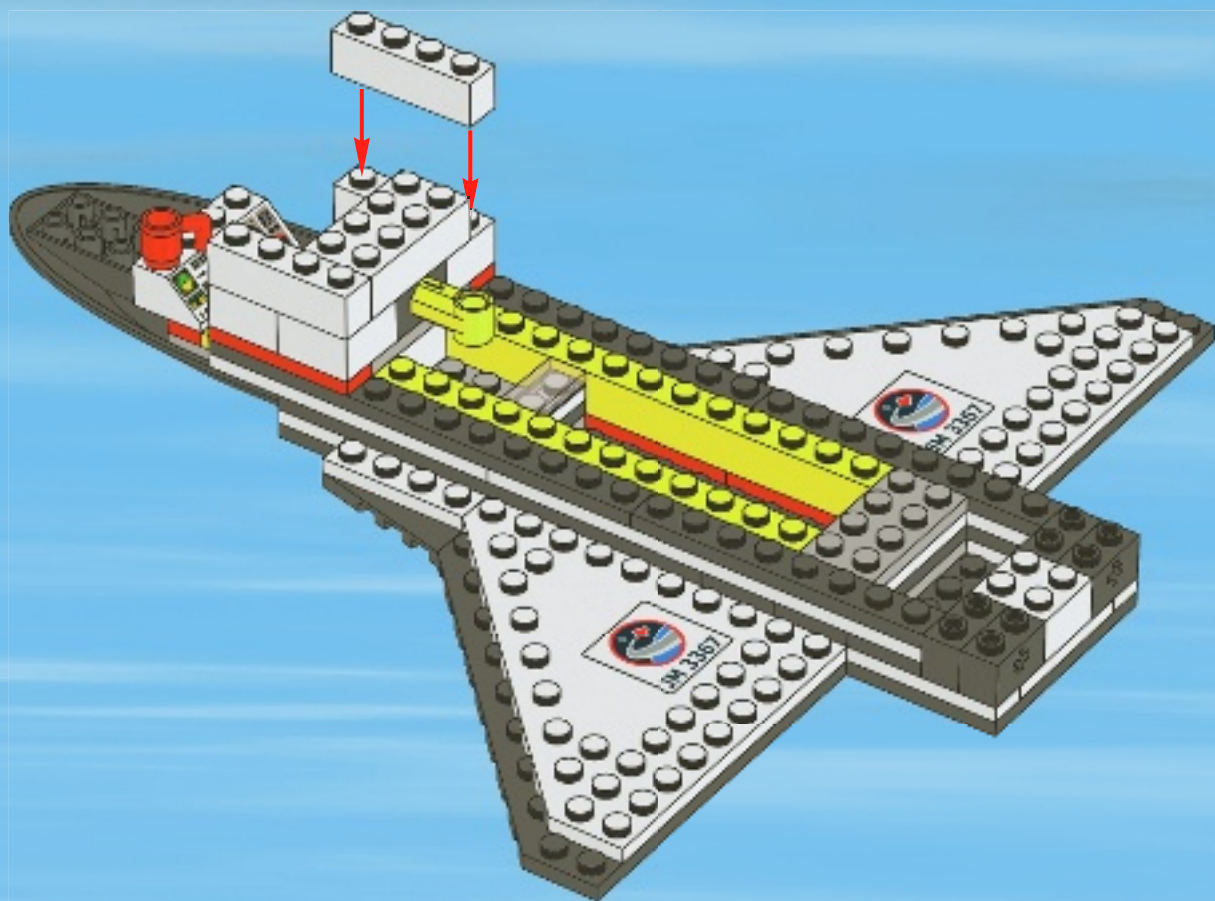

26

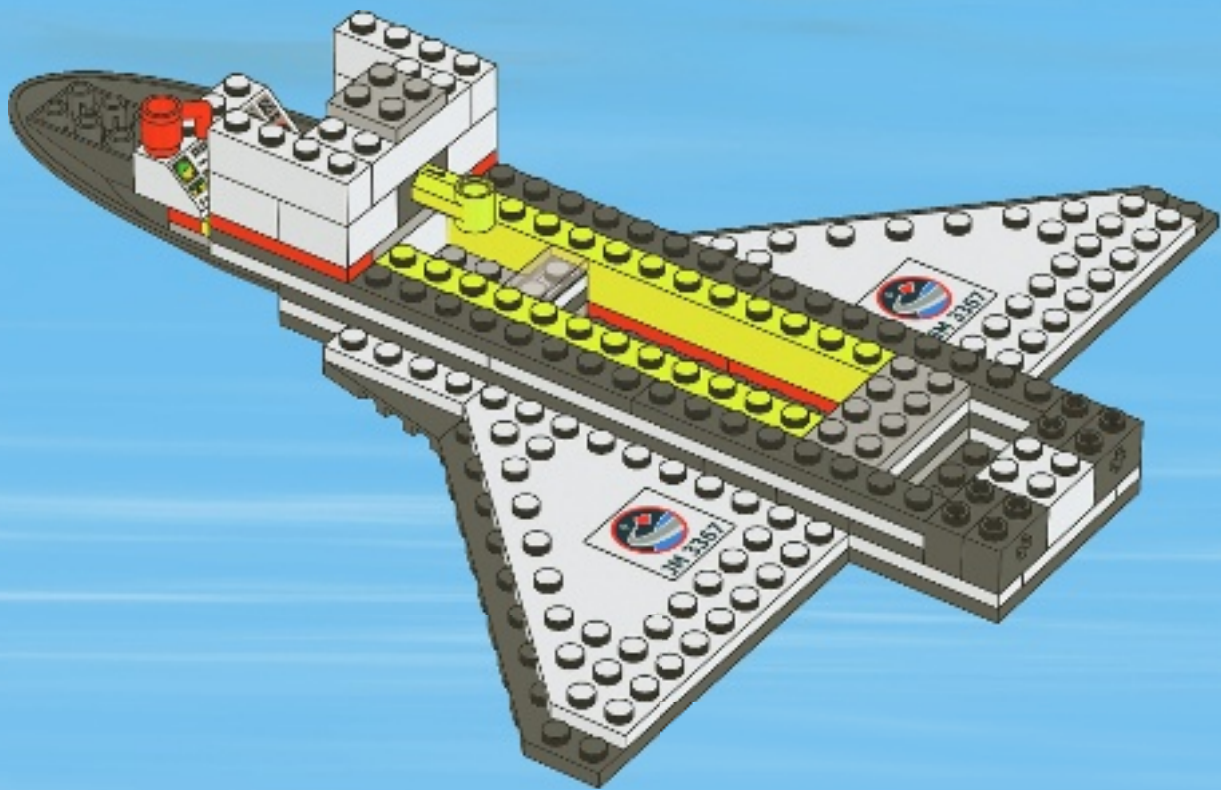

27

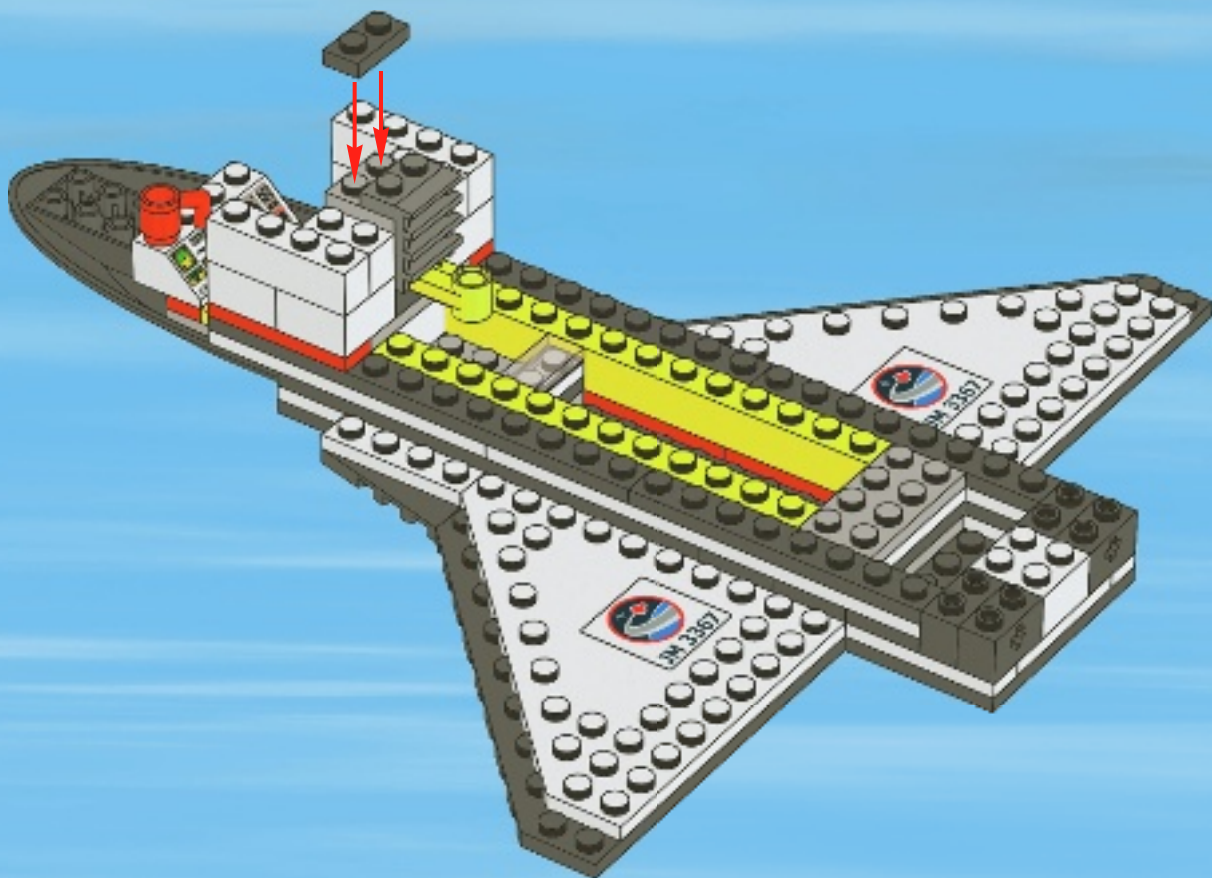

28

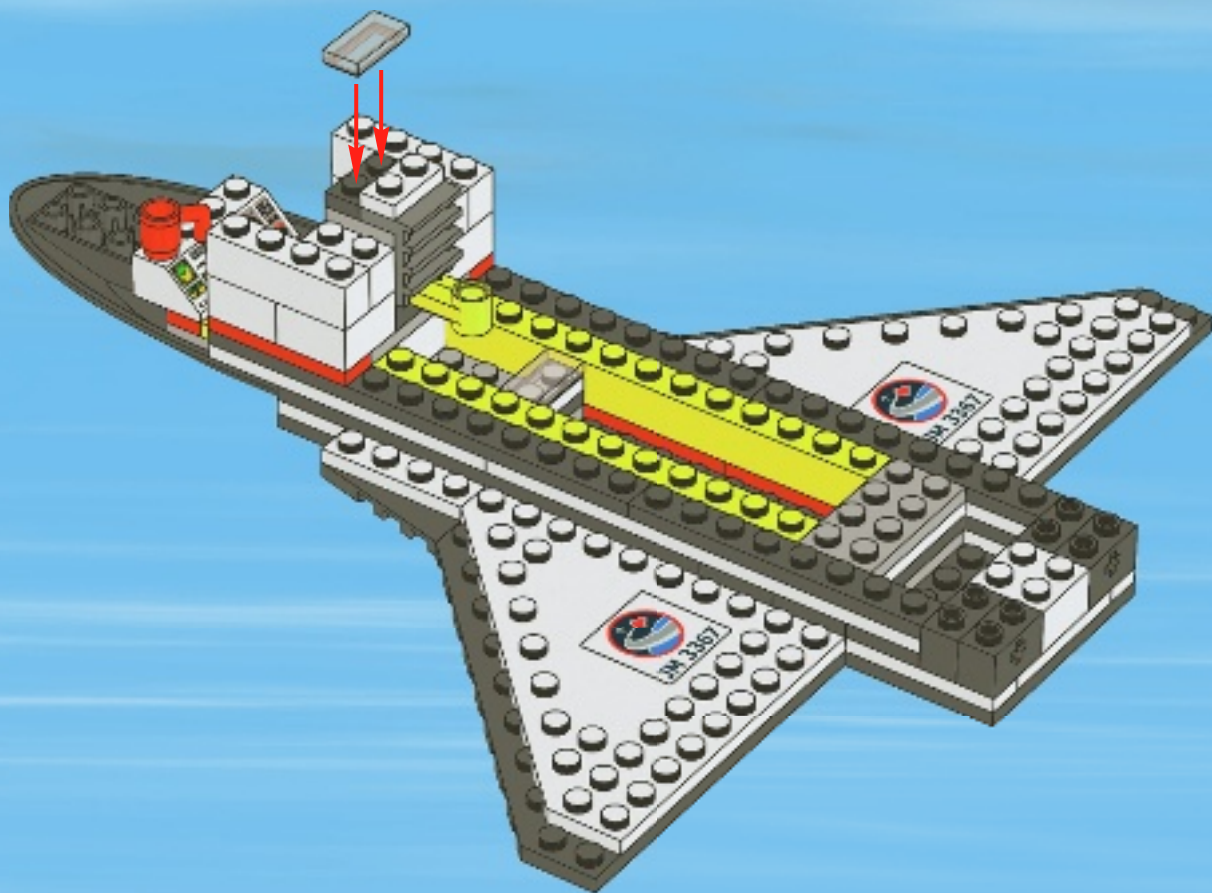

29

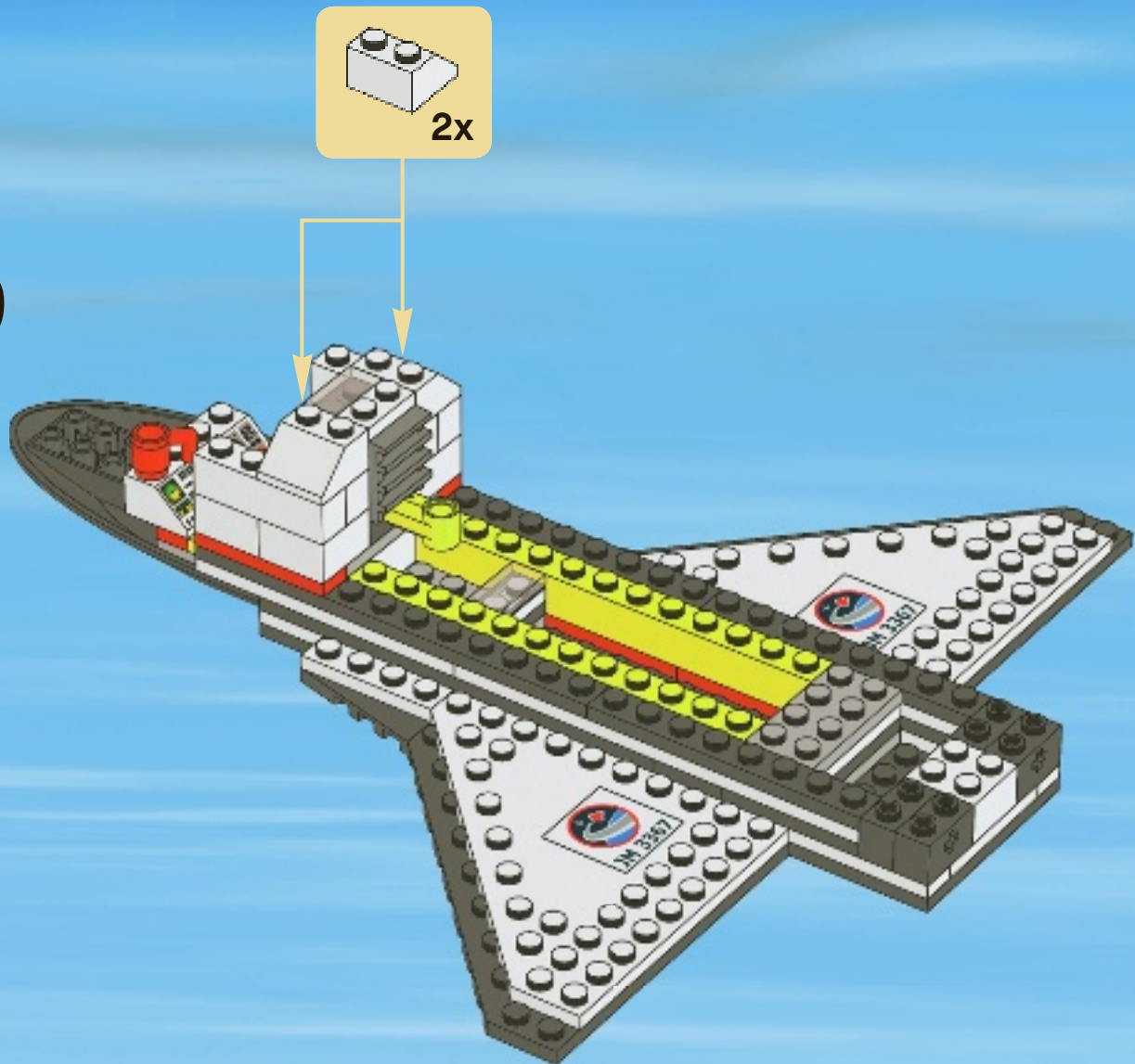

1

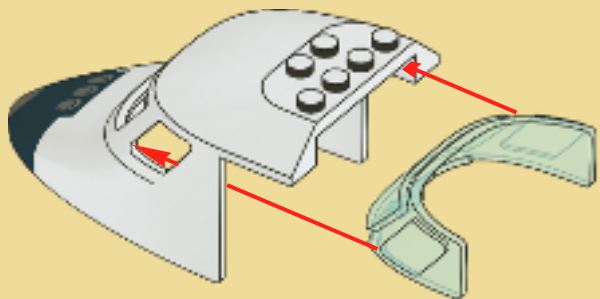

2

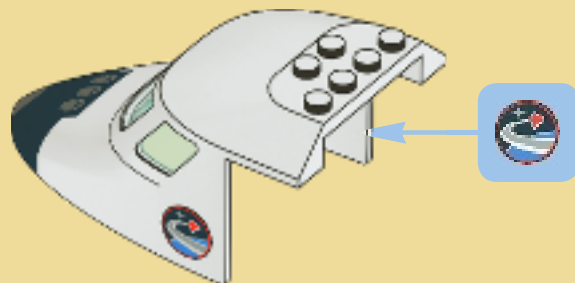

30

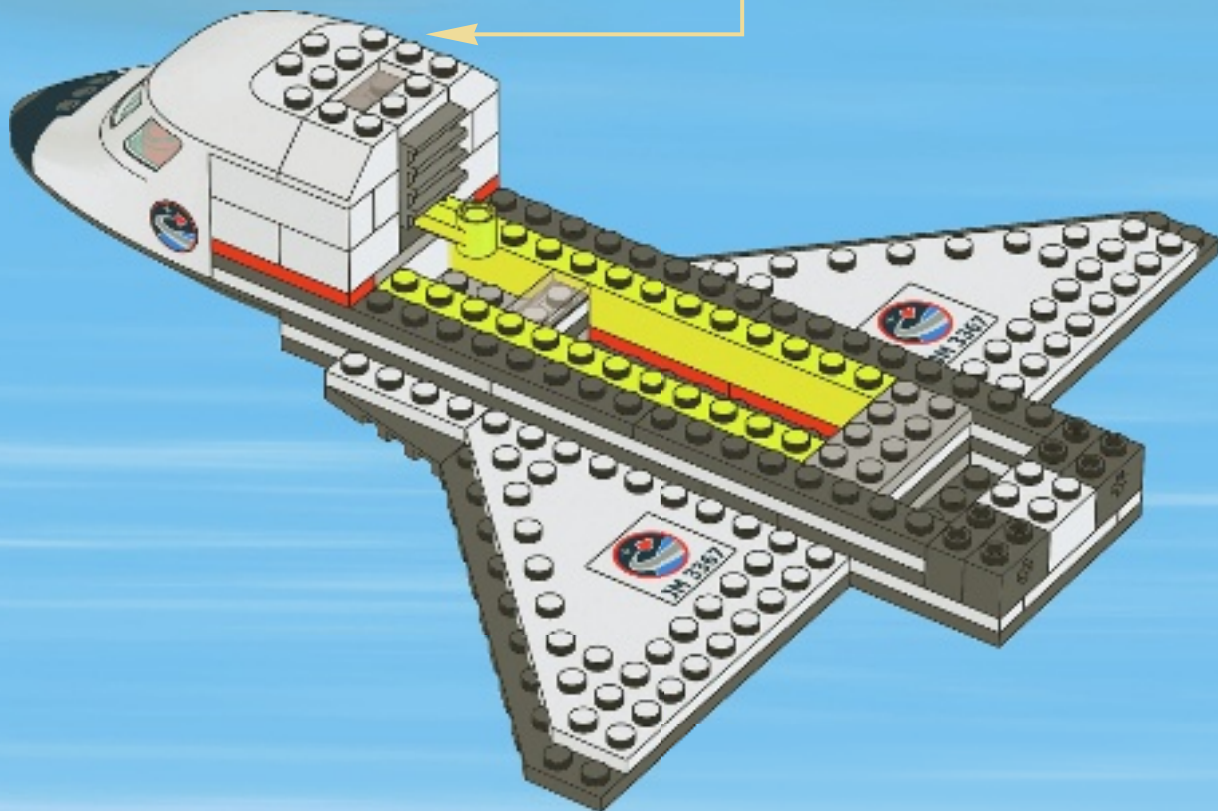

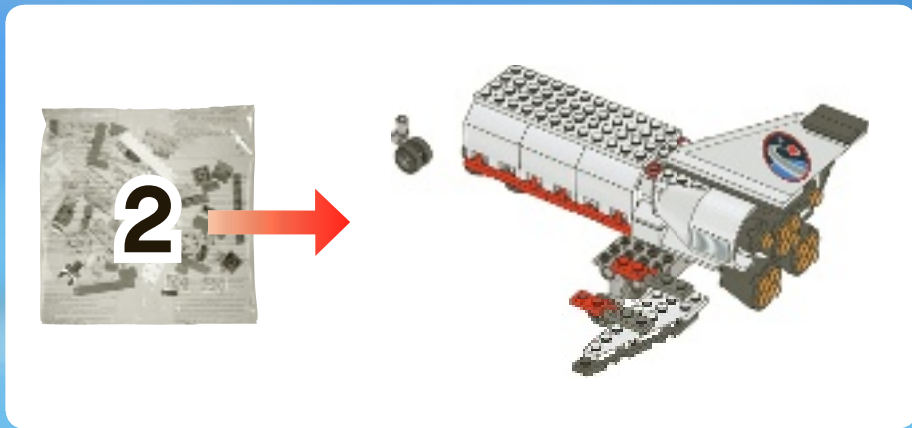

31

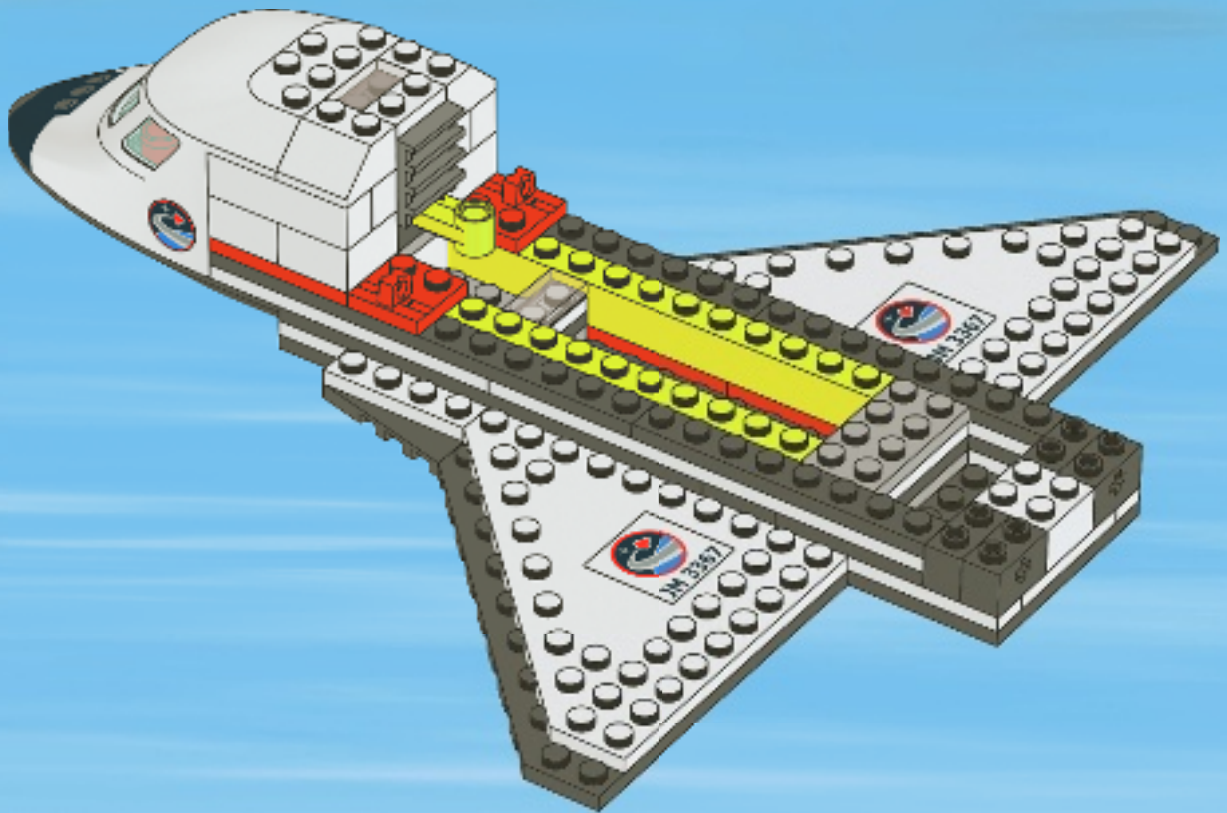

32

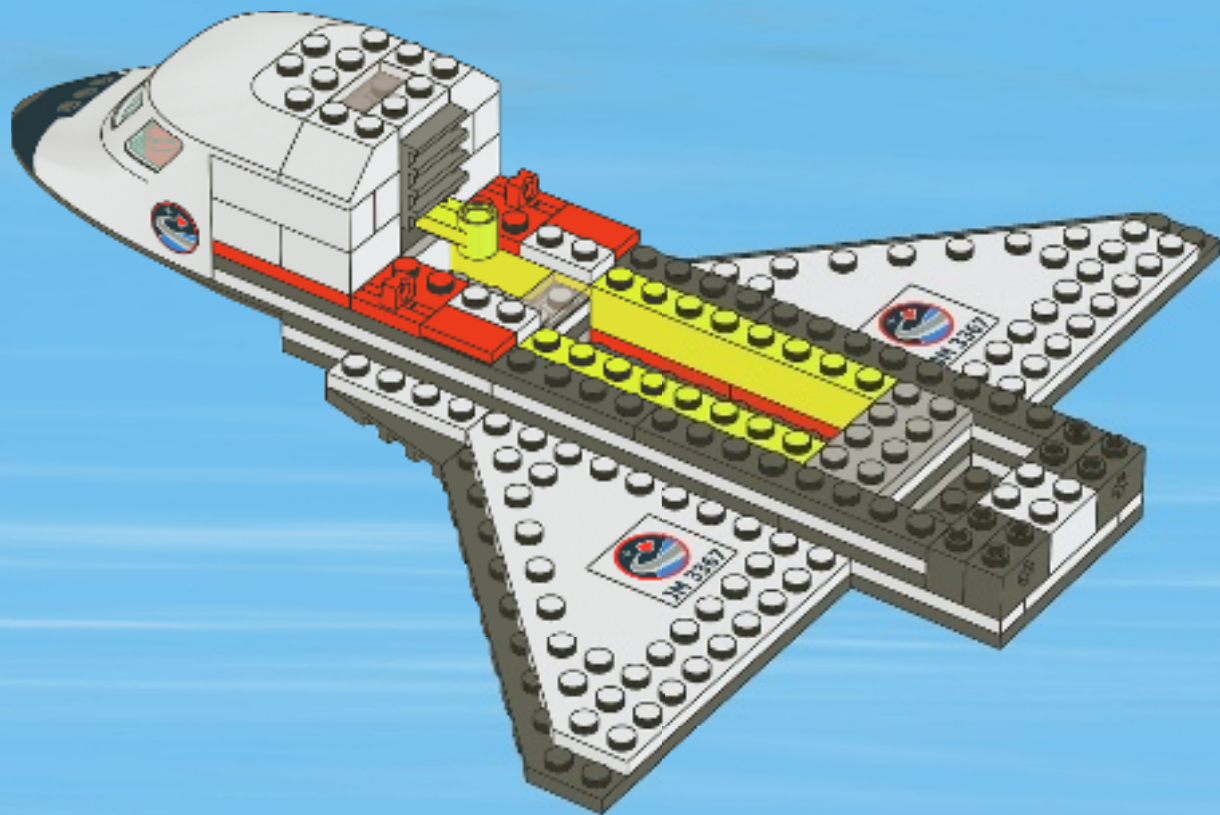

33

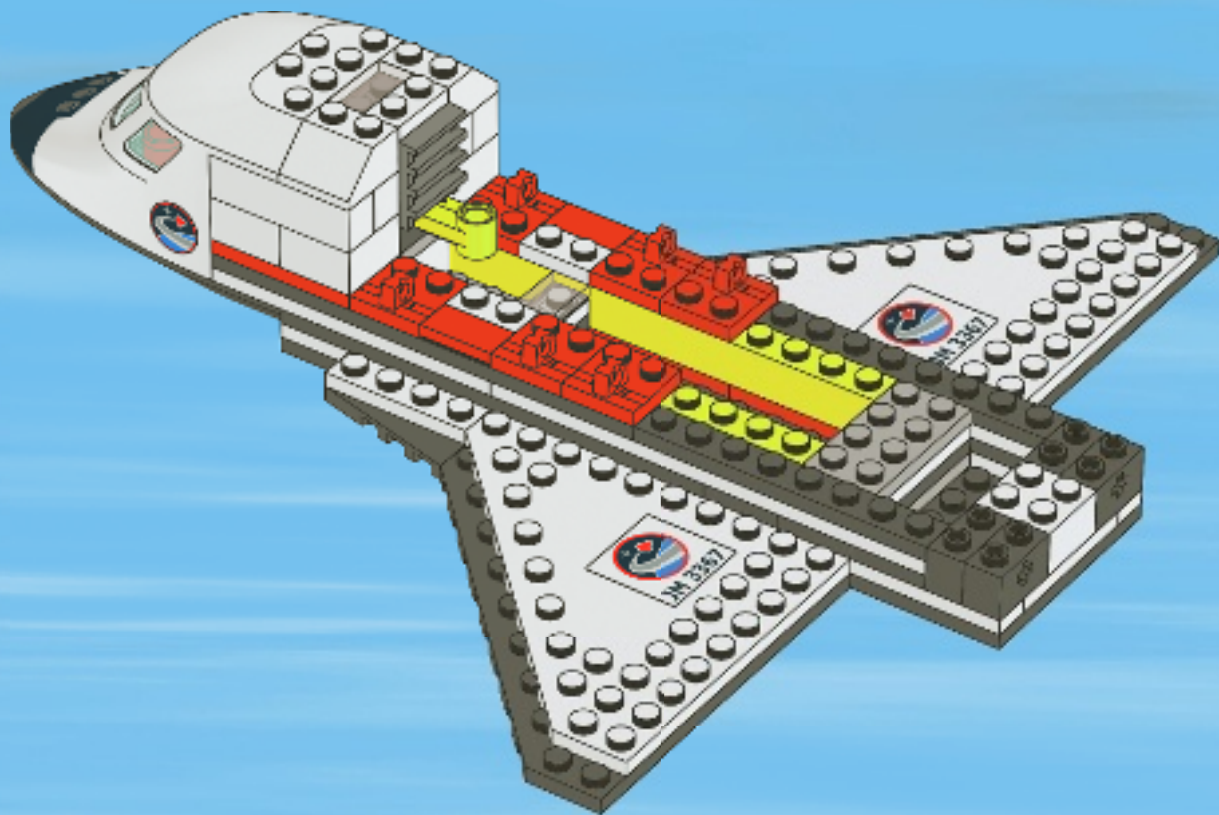

34

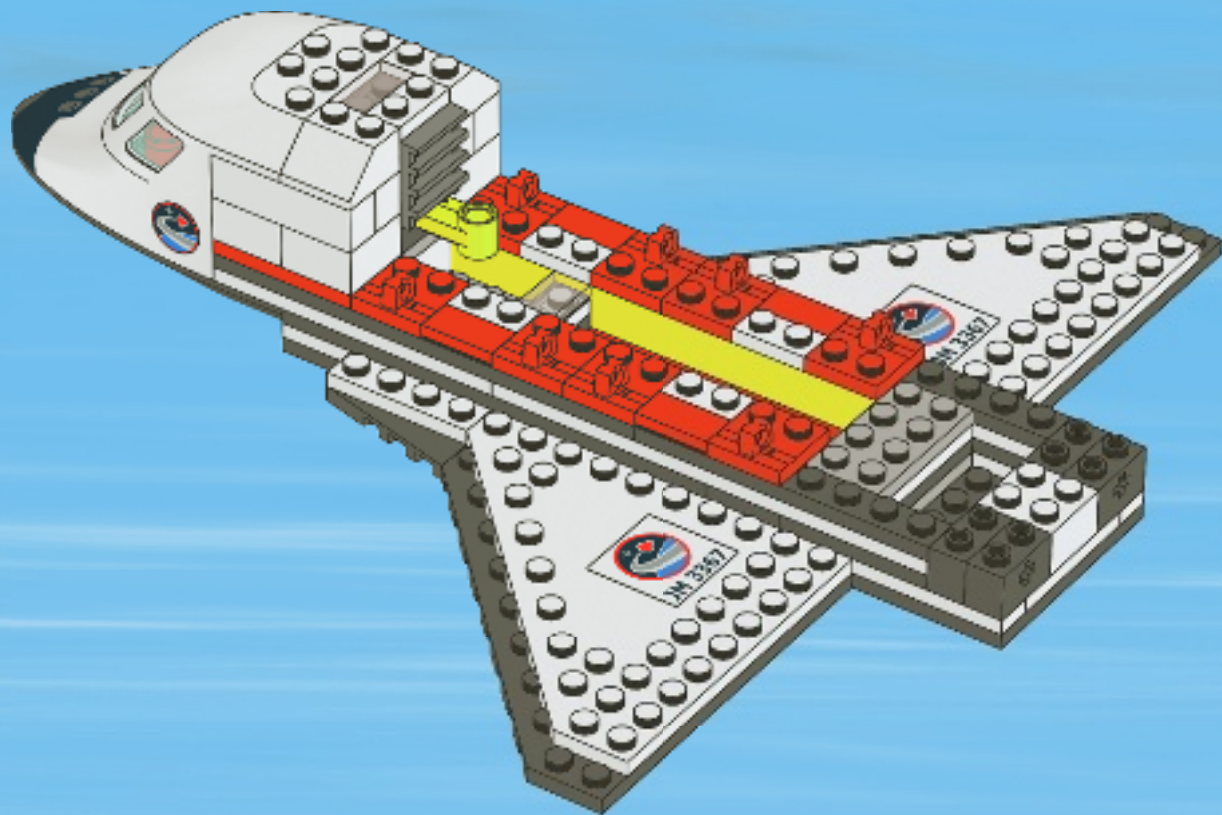

35

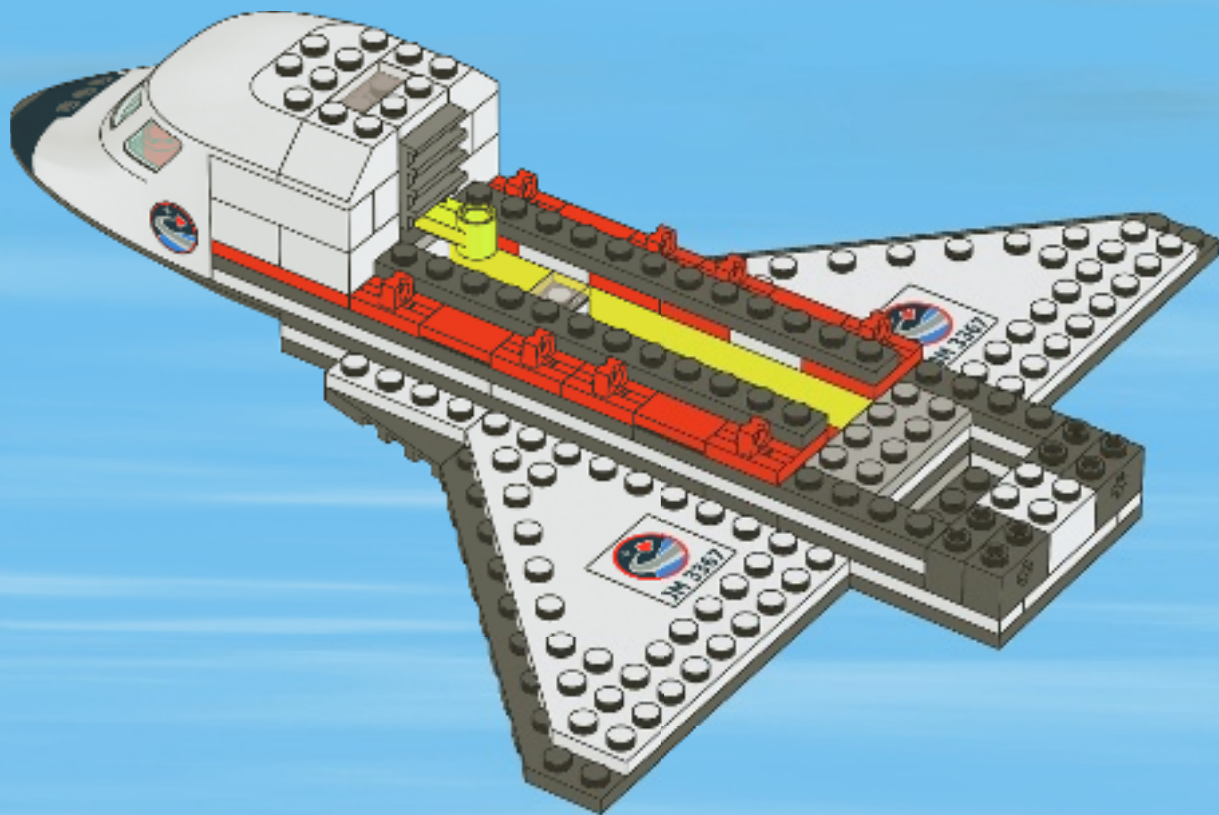

36

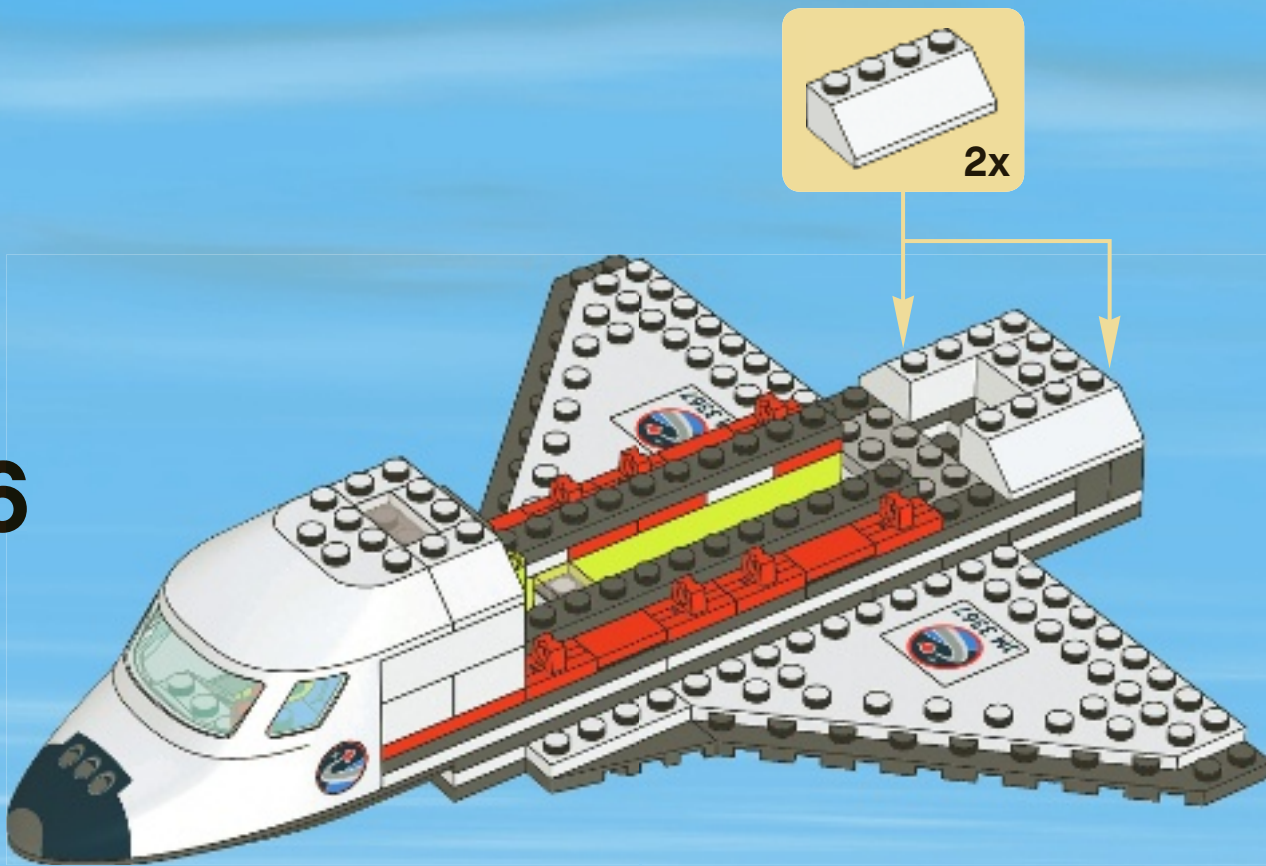

1



2

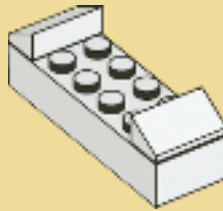

37

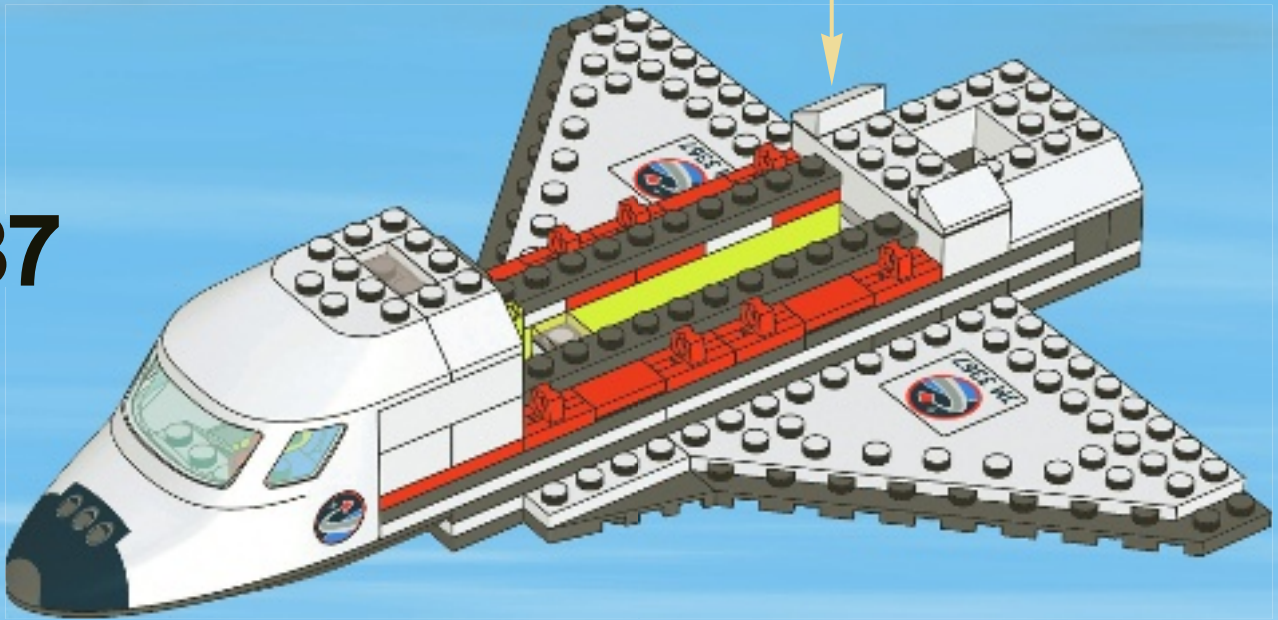

38

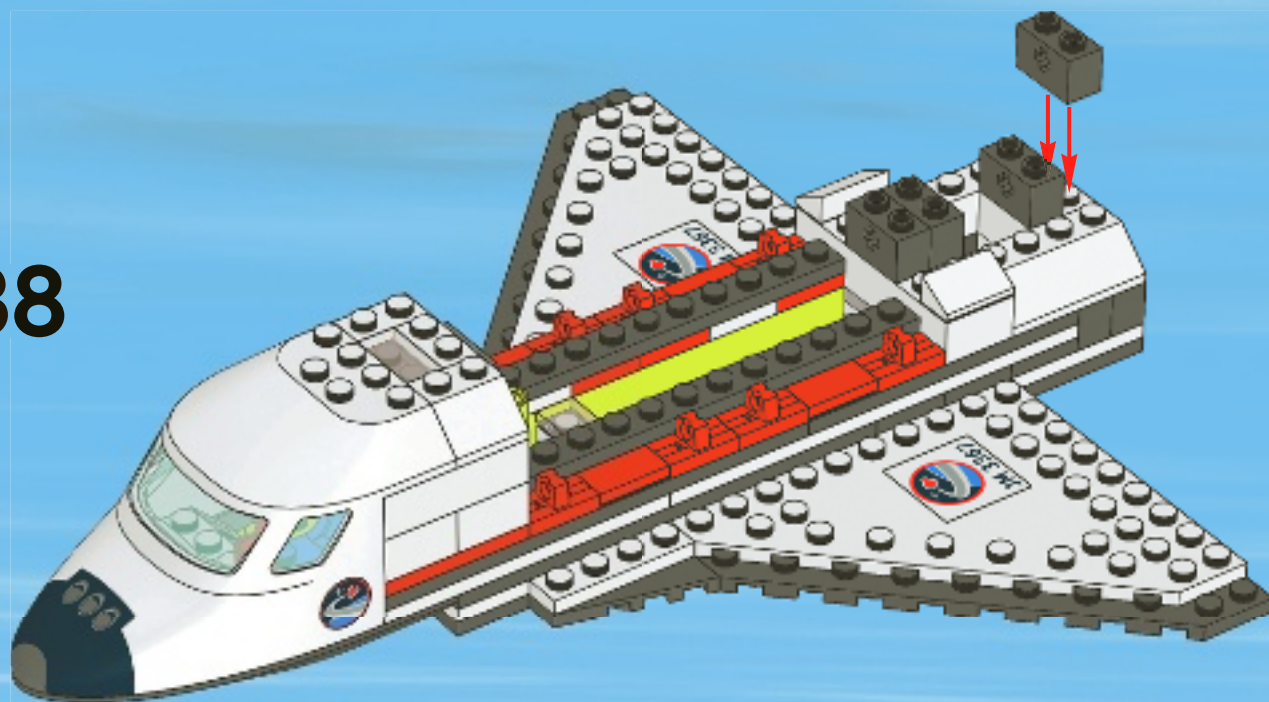

39

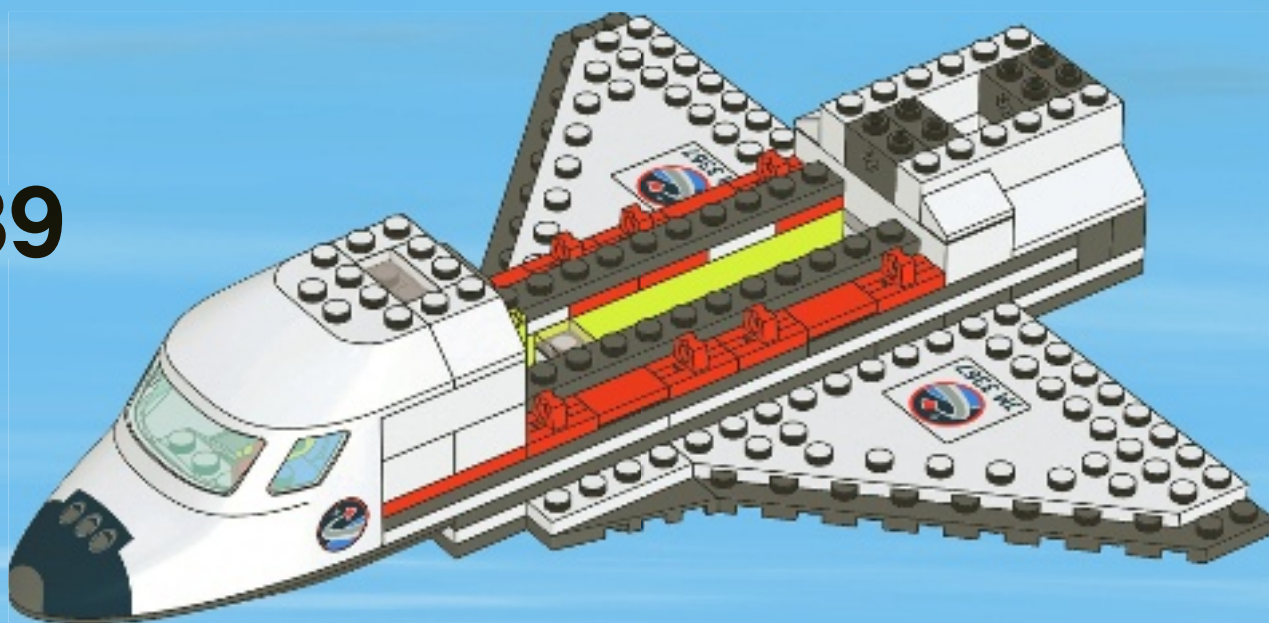

1



2

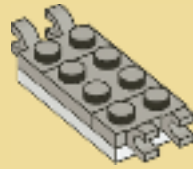

3

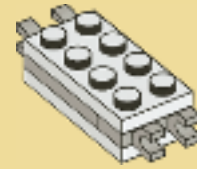

40

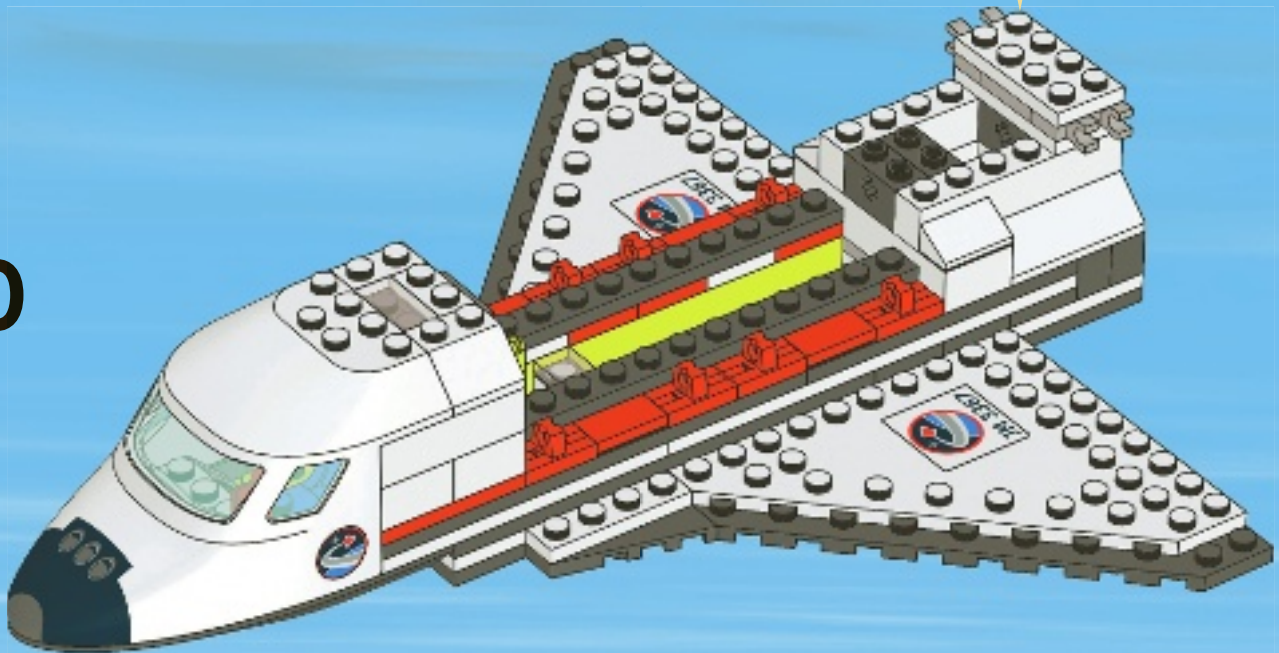

41

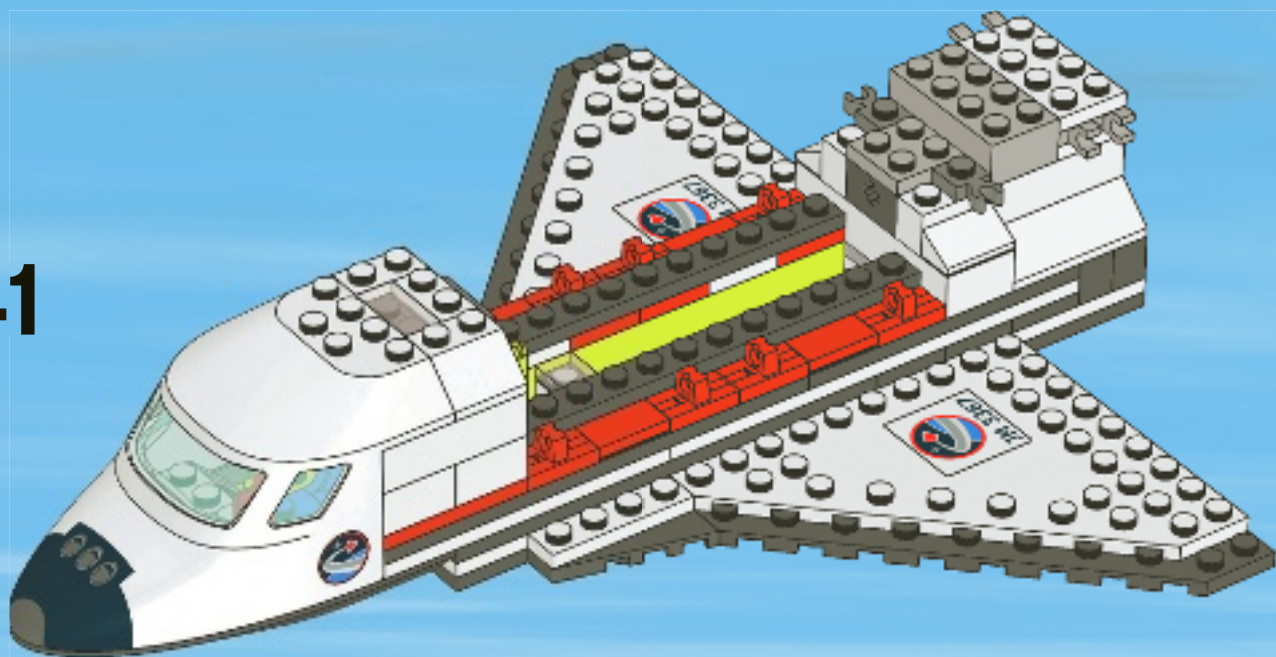

42

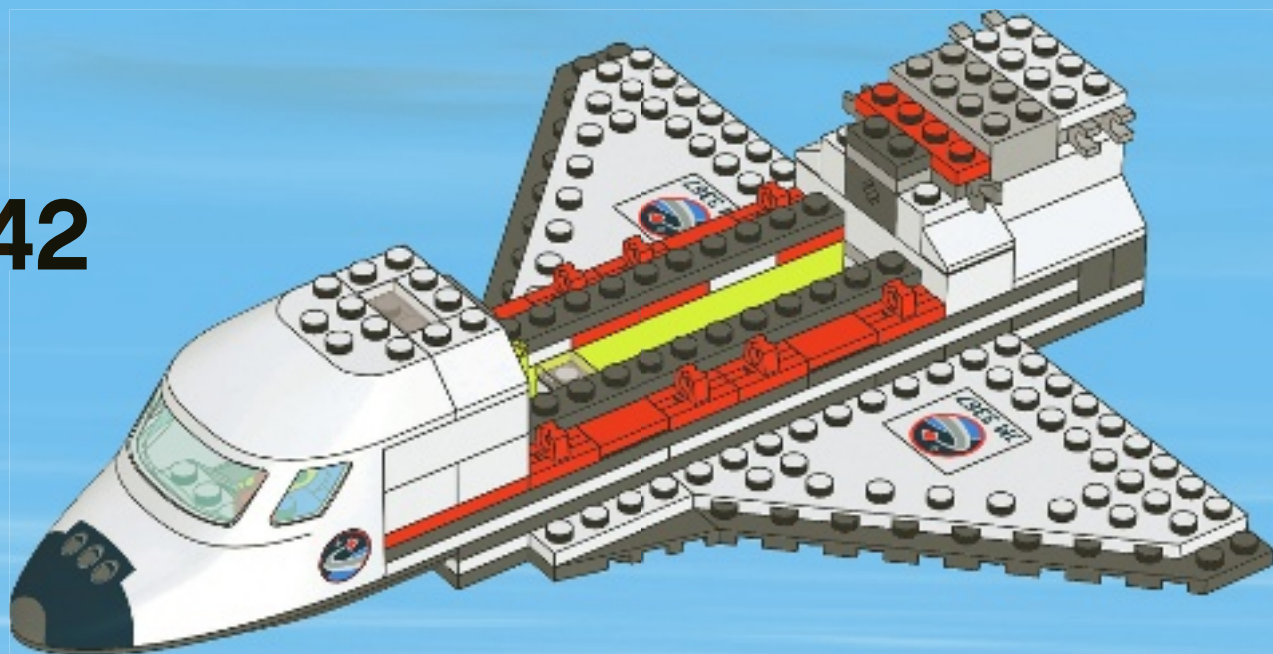

43

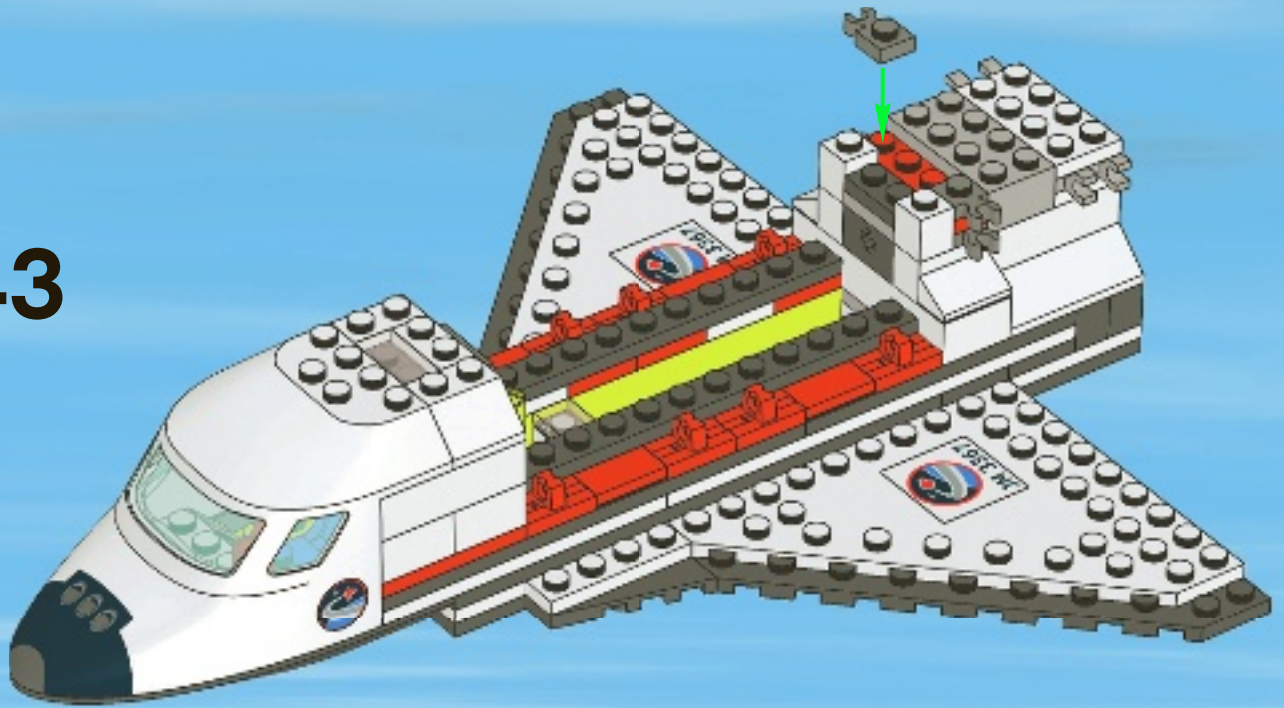

44

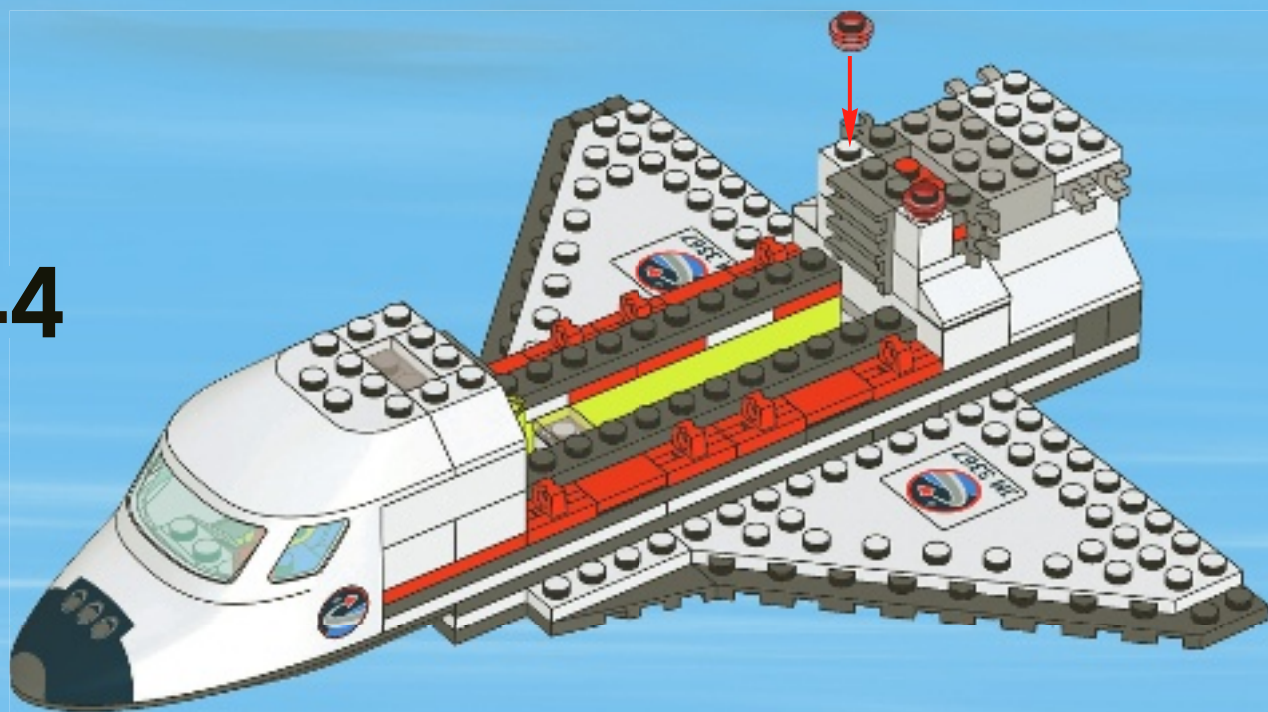

45

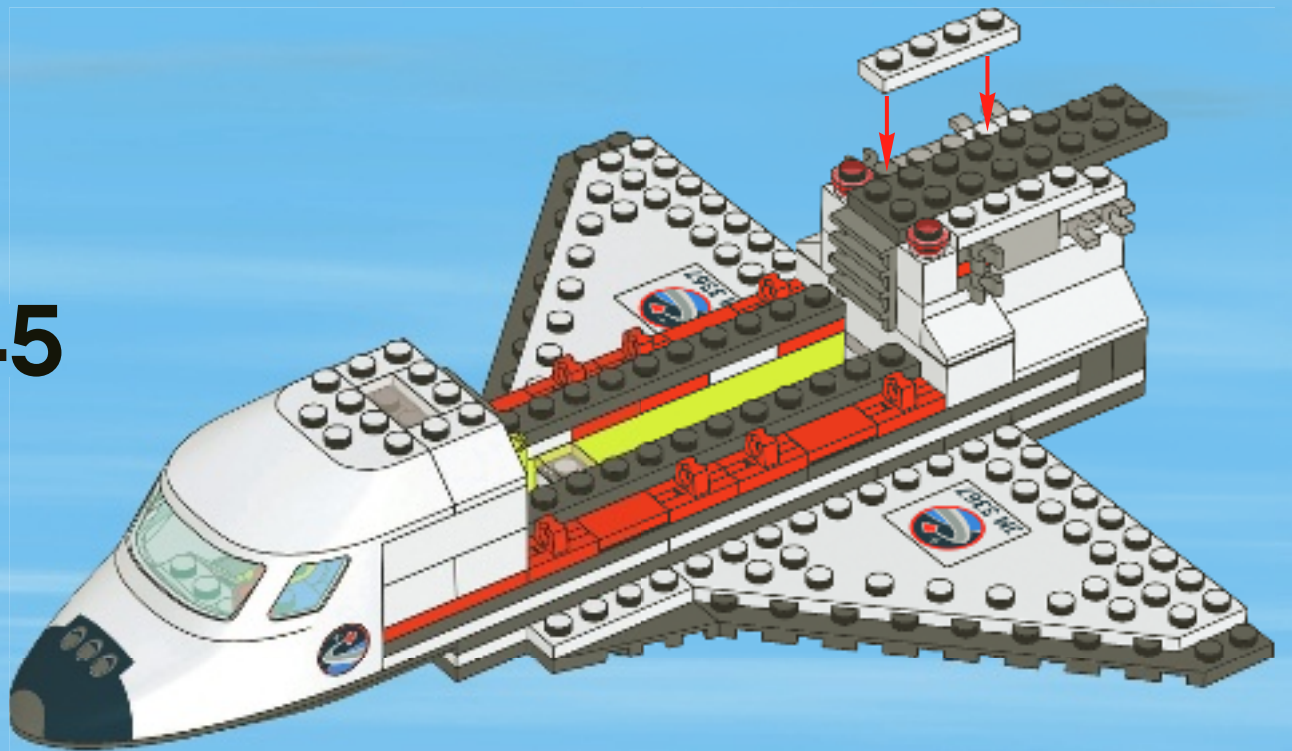

46

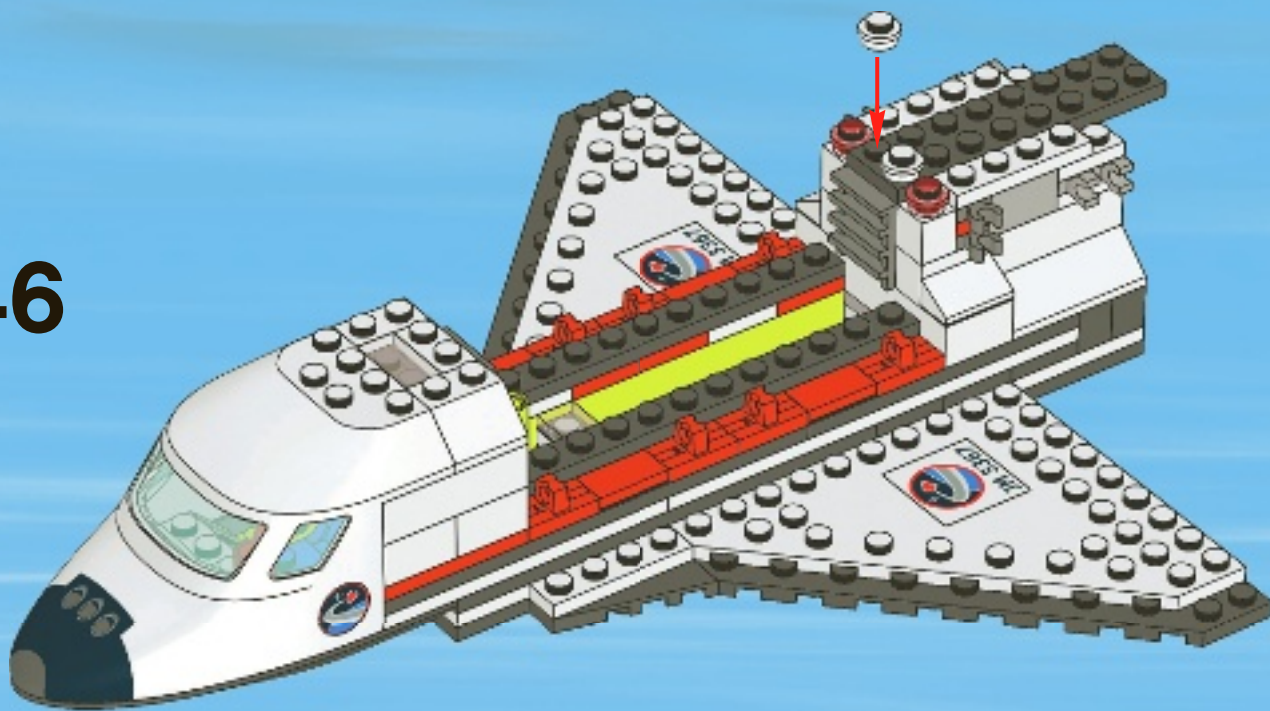

47

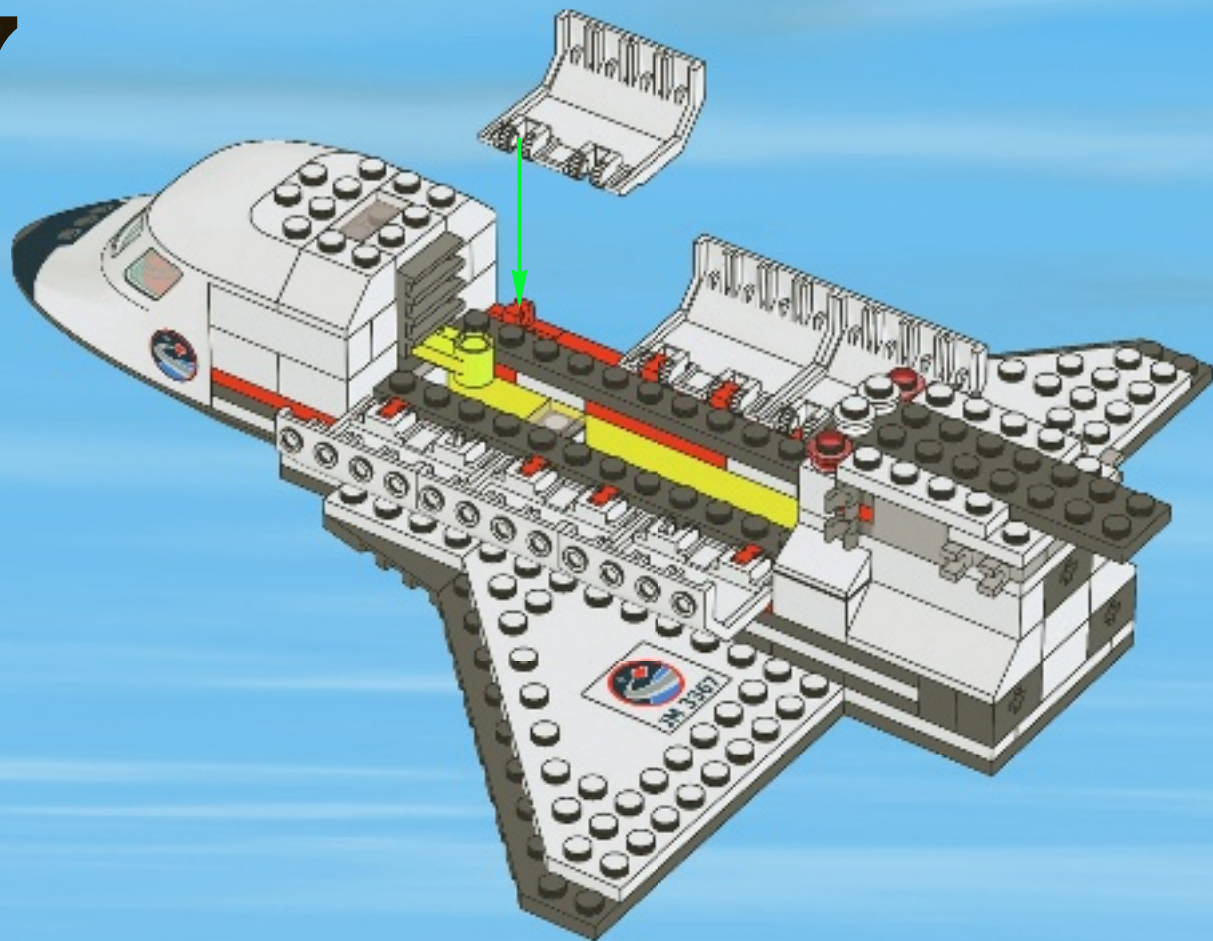

48

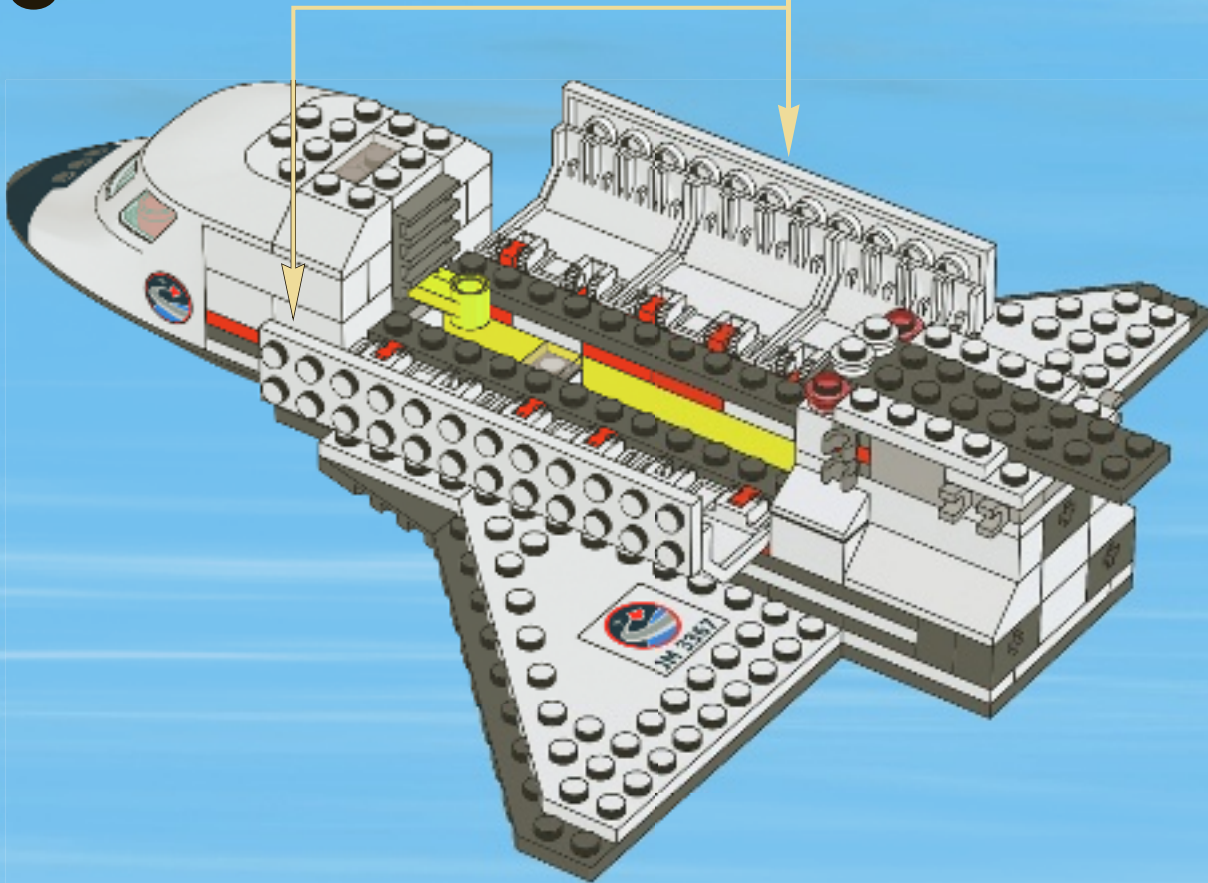
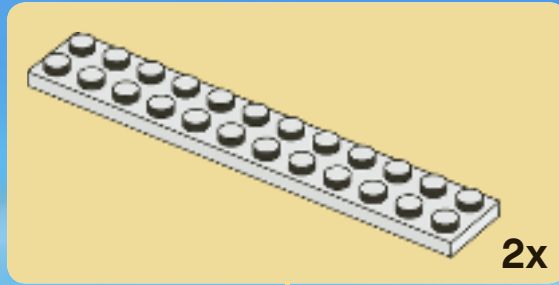

49

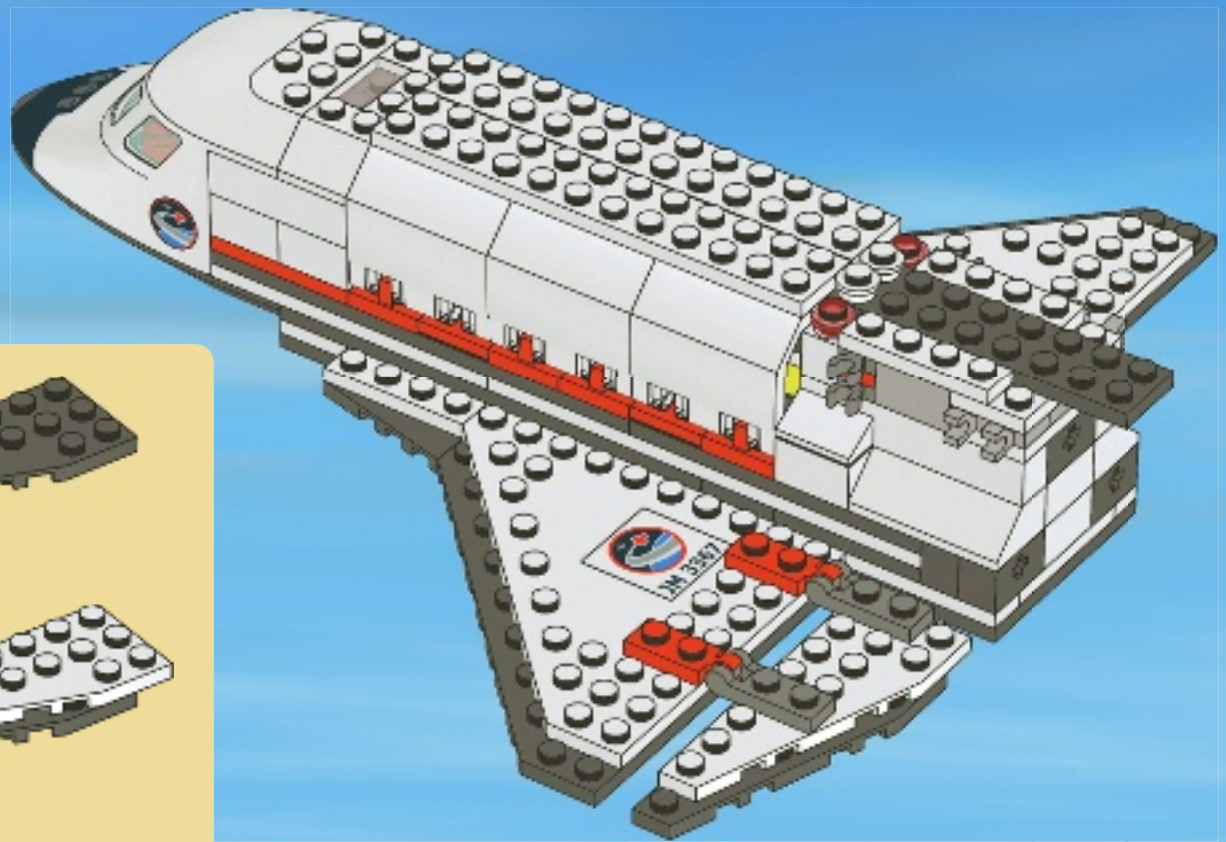

1



2

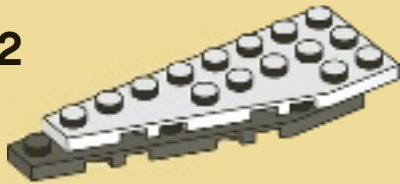

3

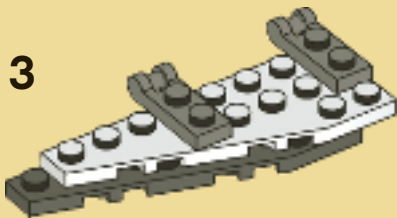

4

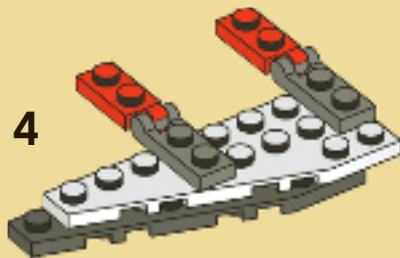

50

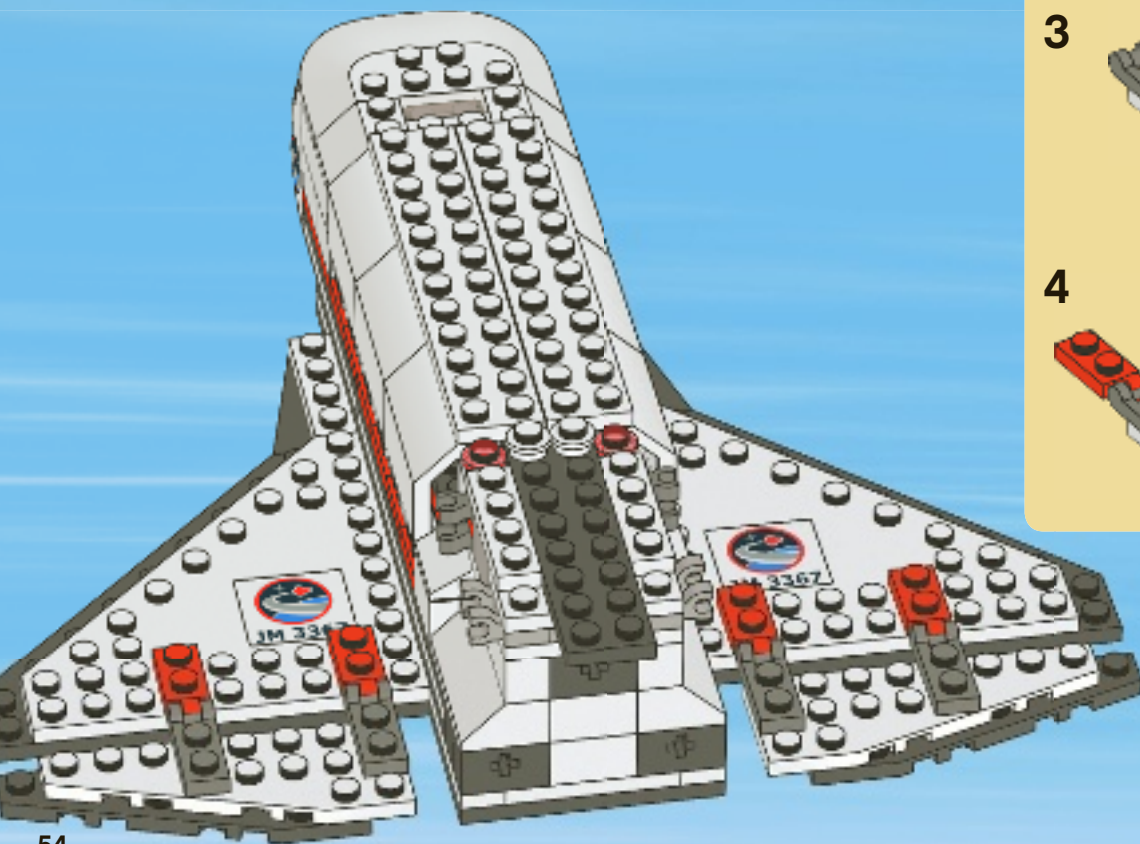

1



2

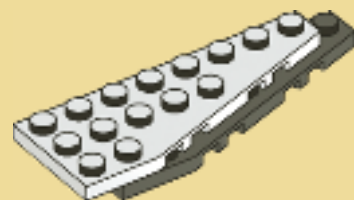

3



4



51

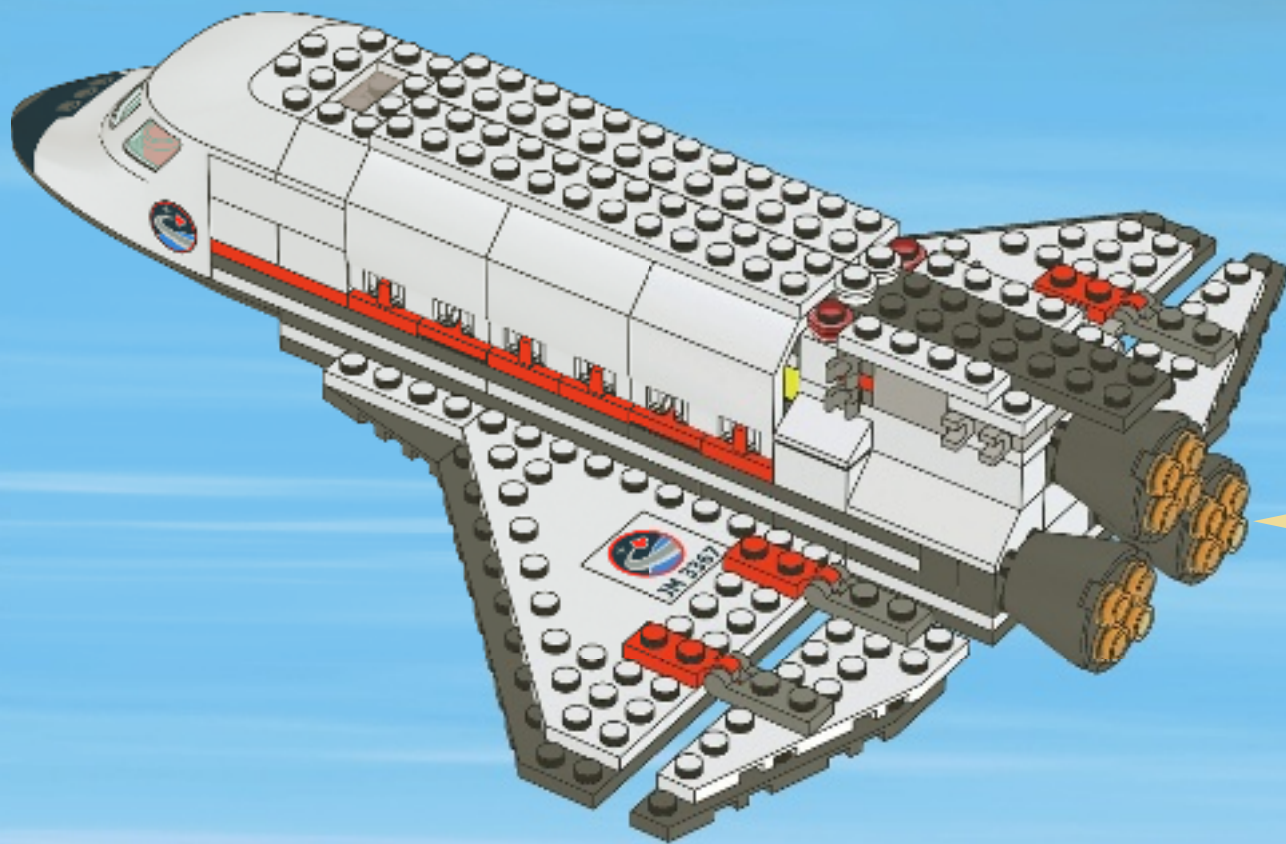

52

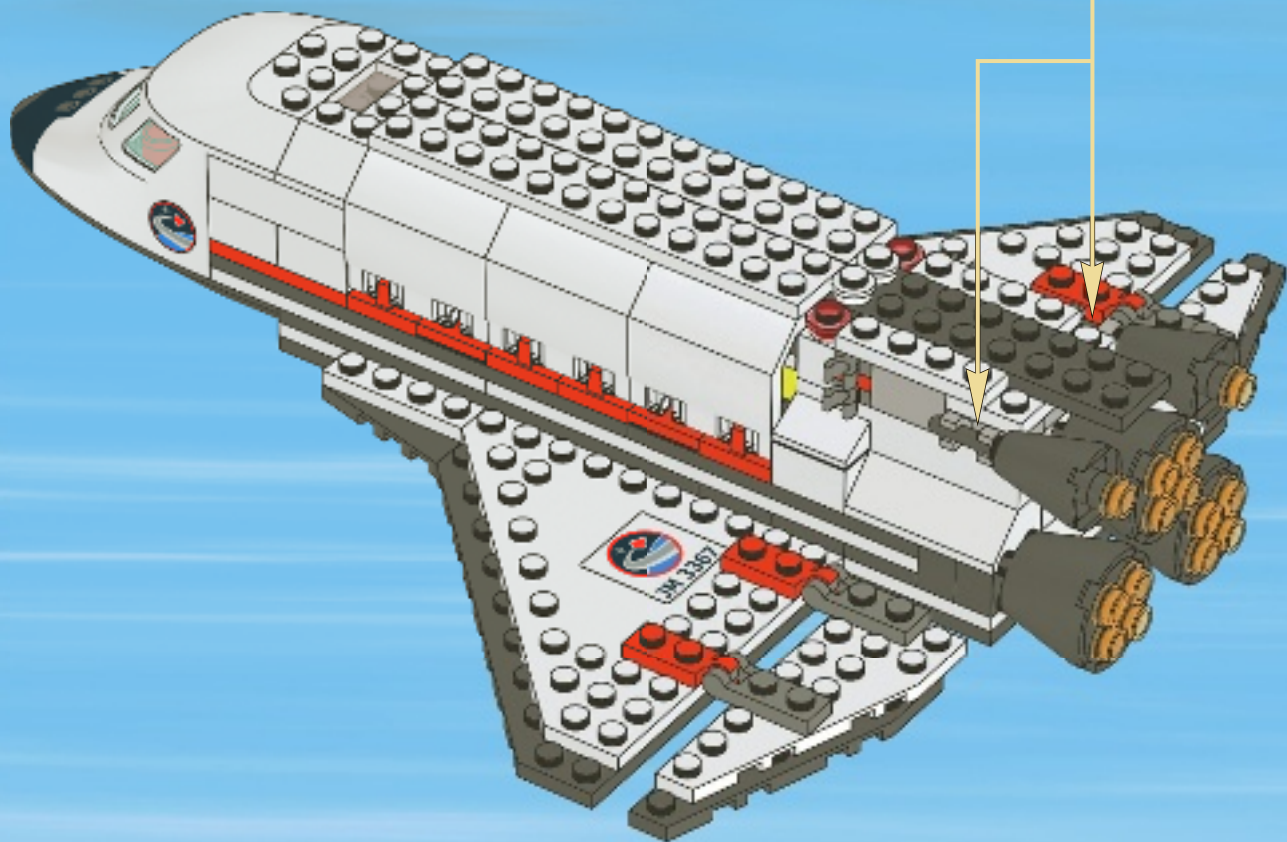

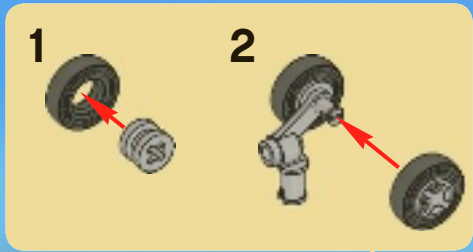

53

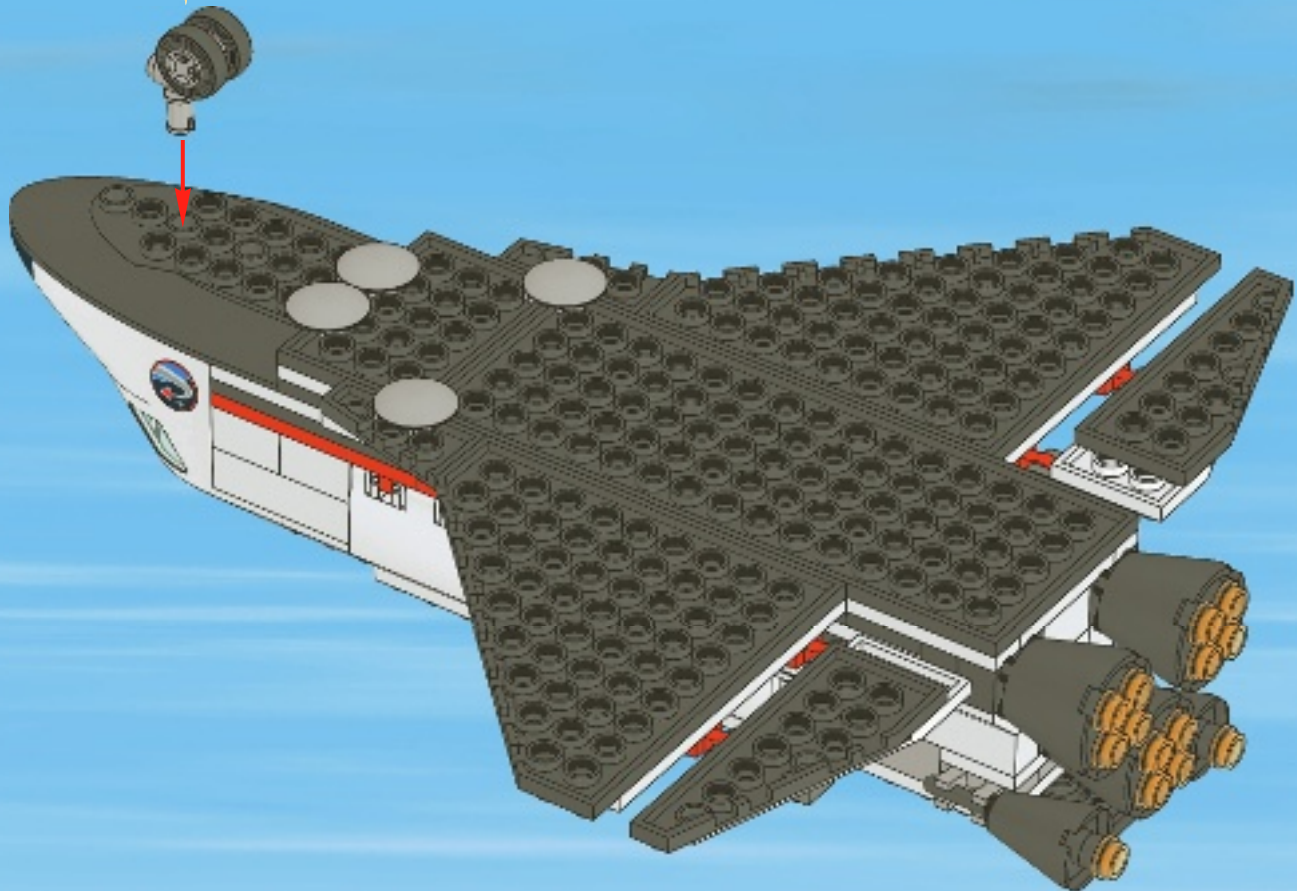

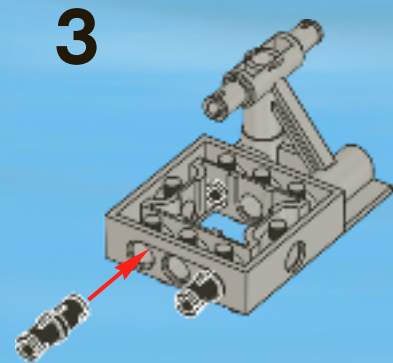
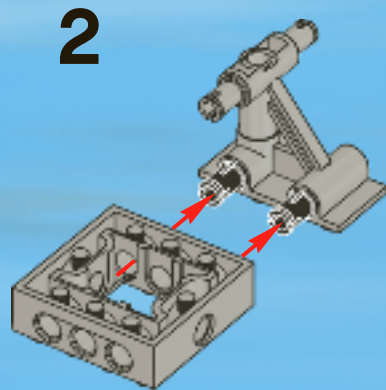
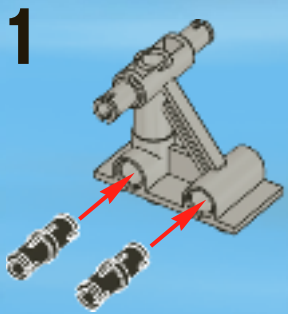

4

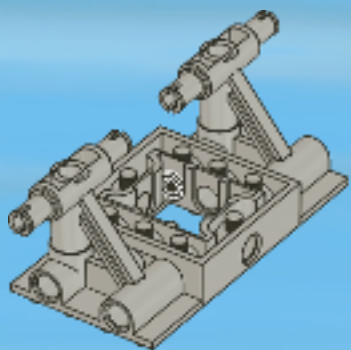

5

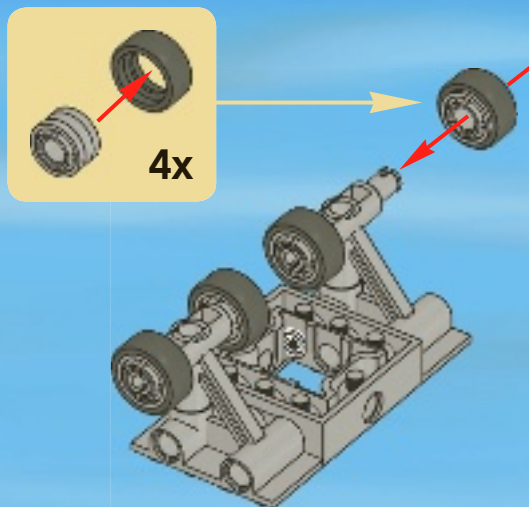

54

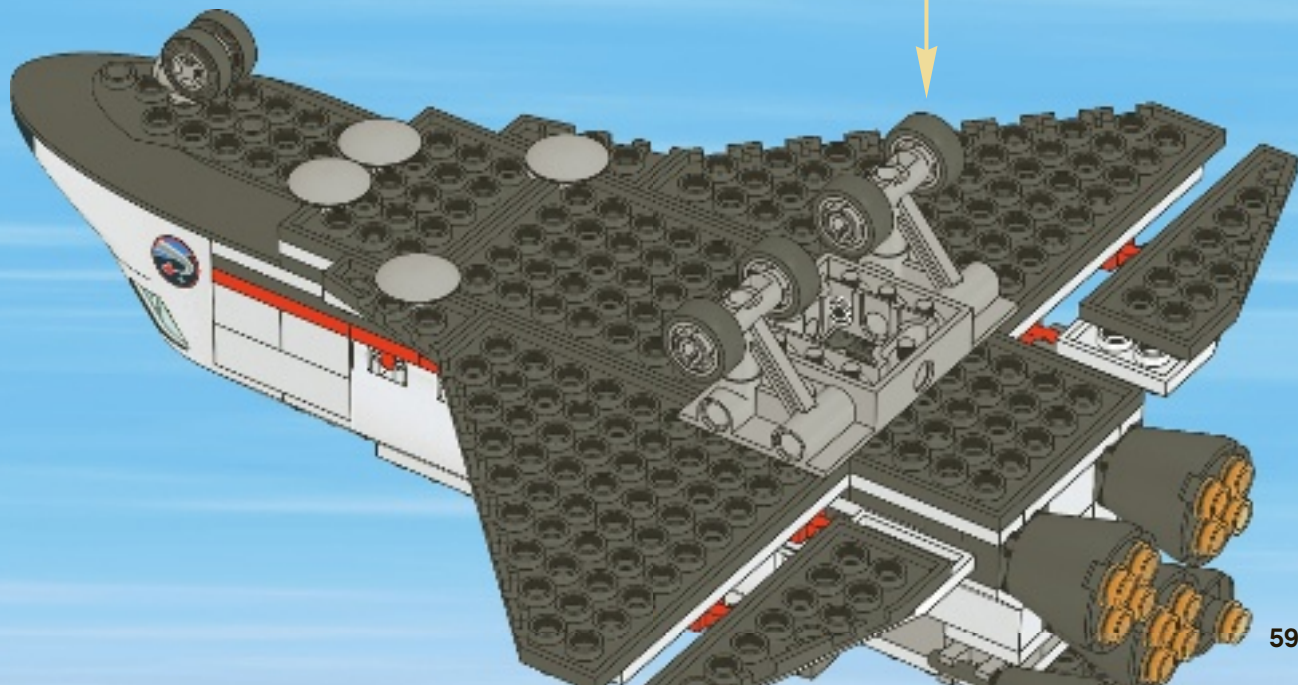

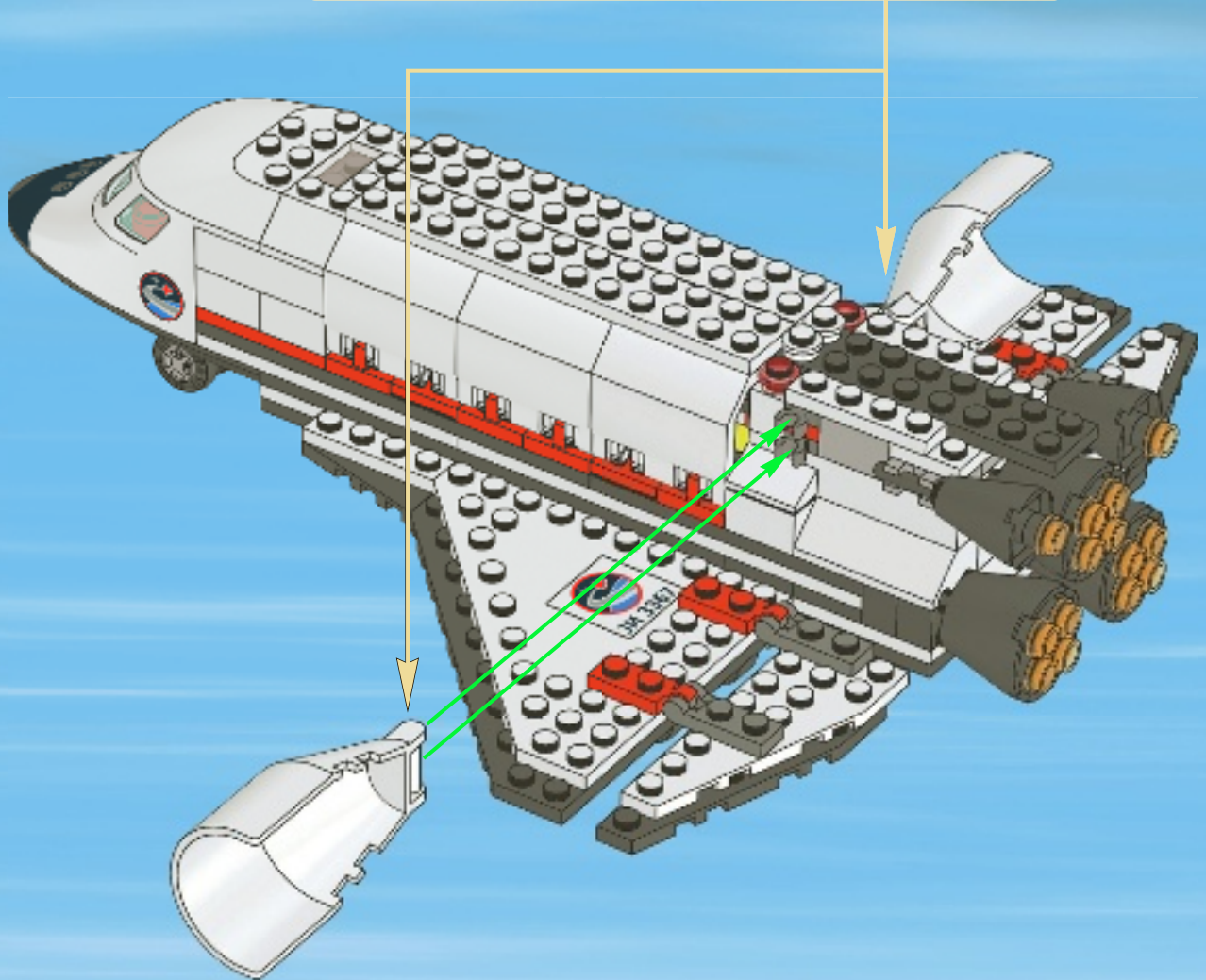
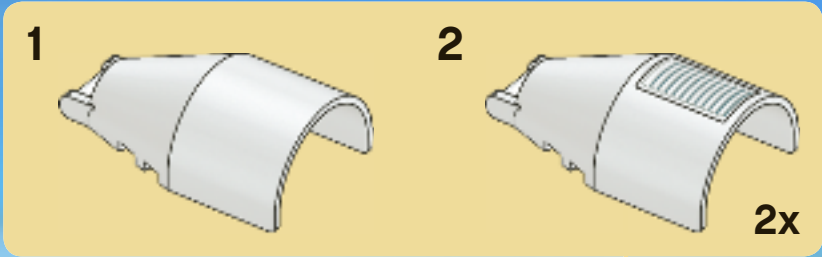

1

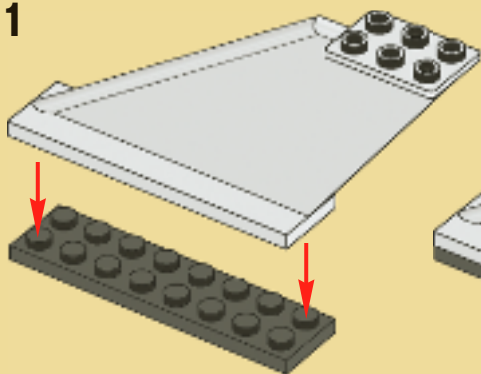

2

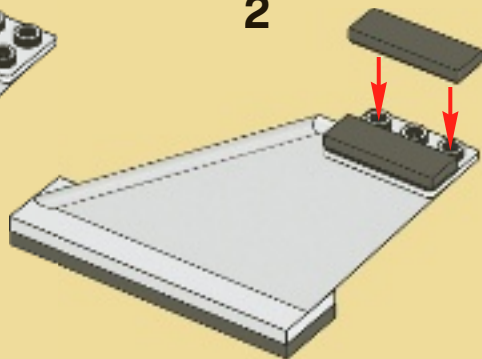

3

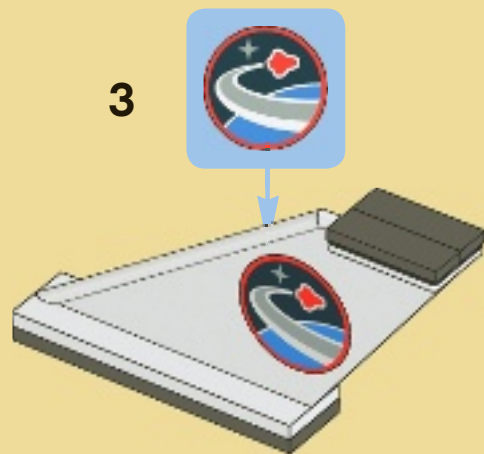

56

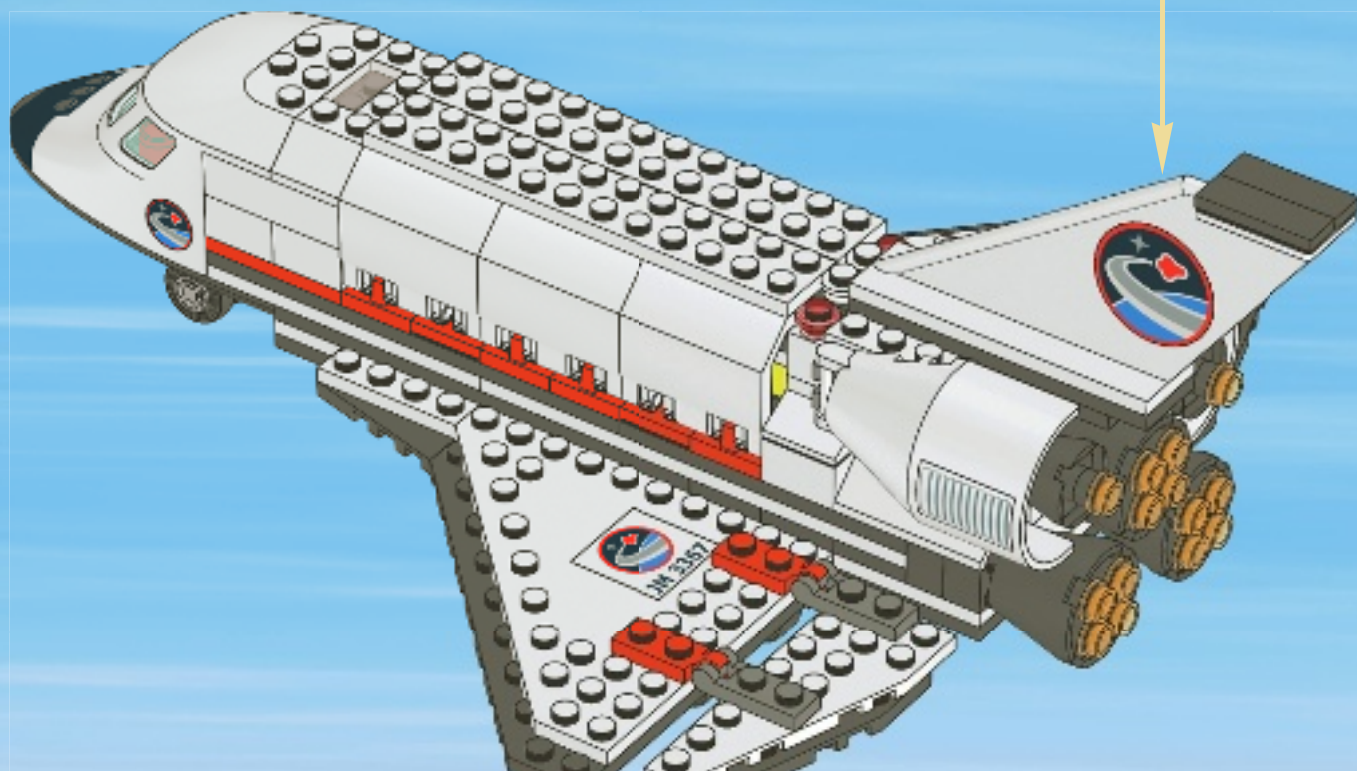

1

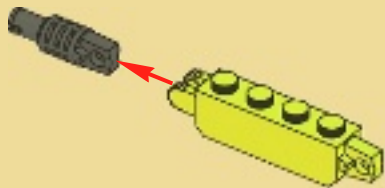

2

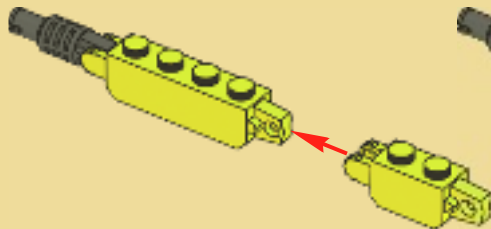

3

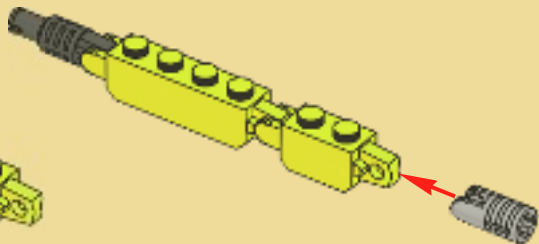

57

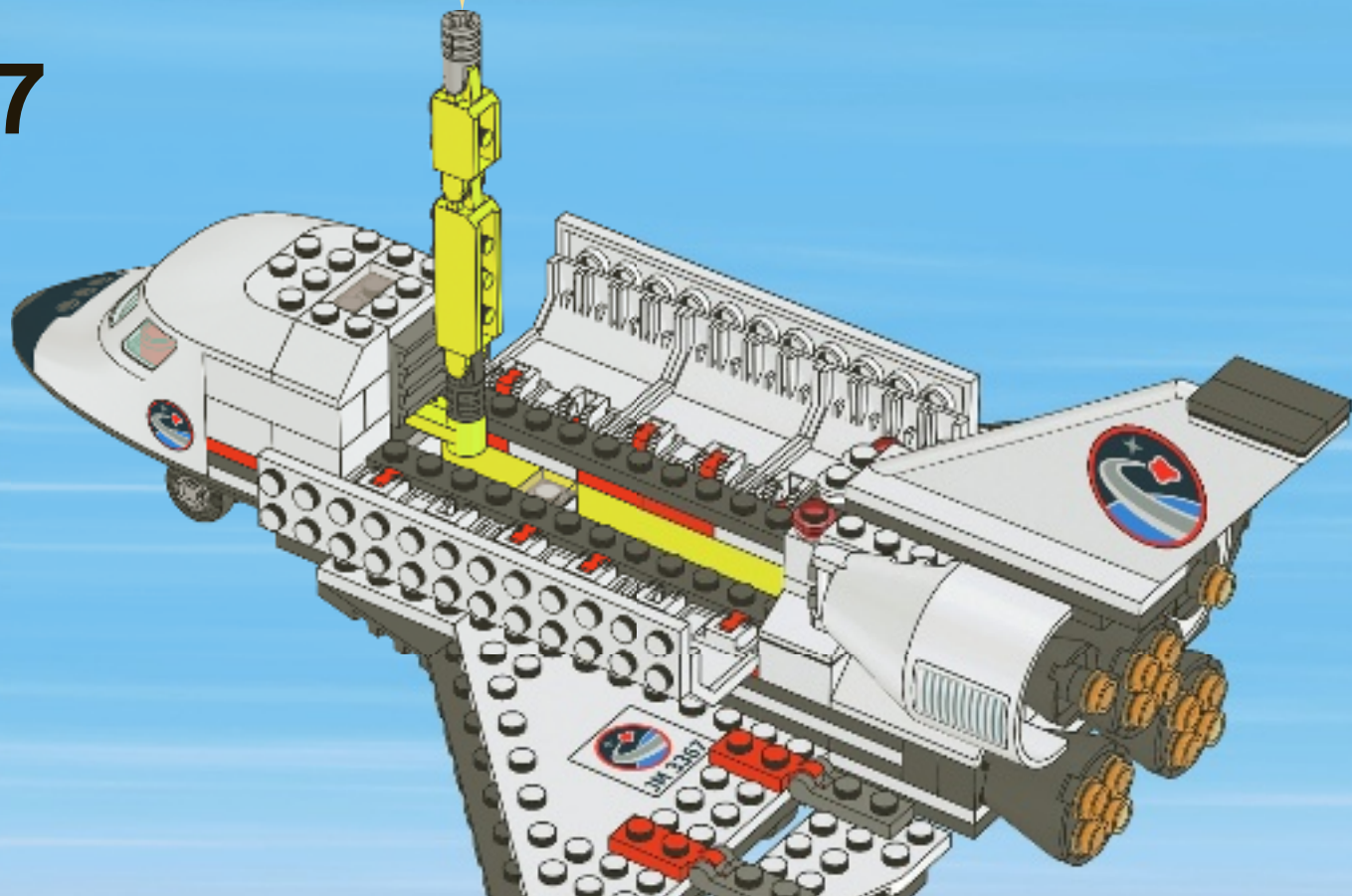

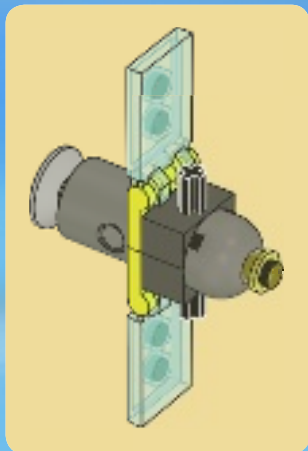

58

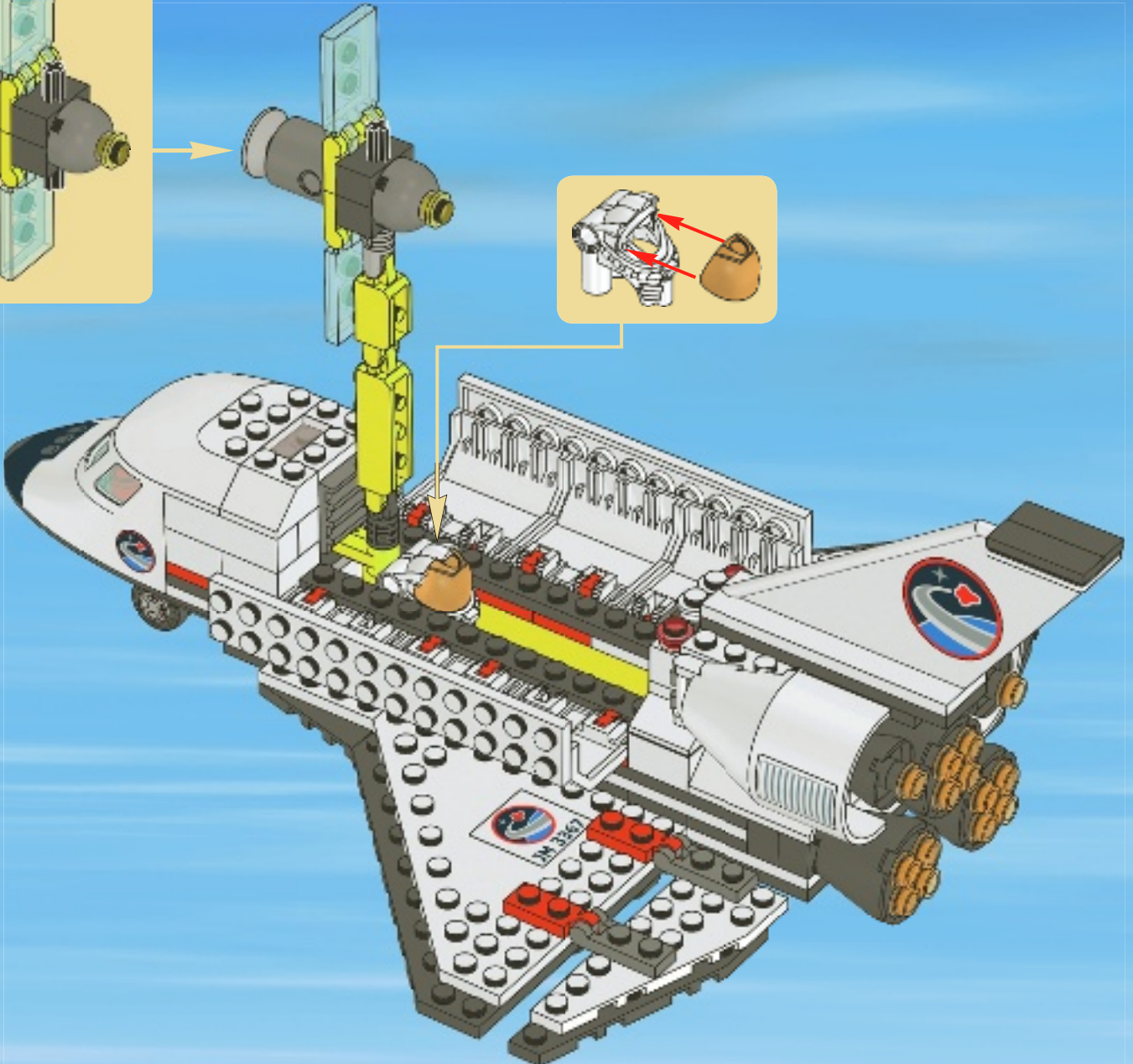
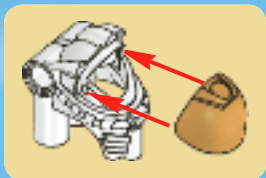

59

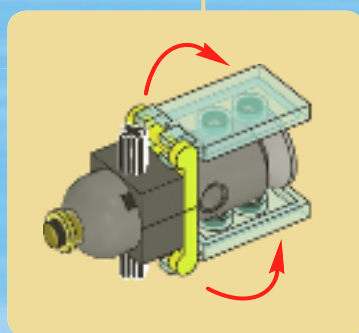

60

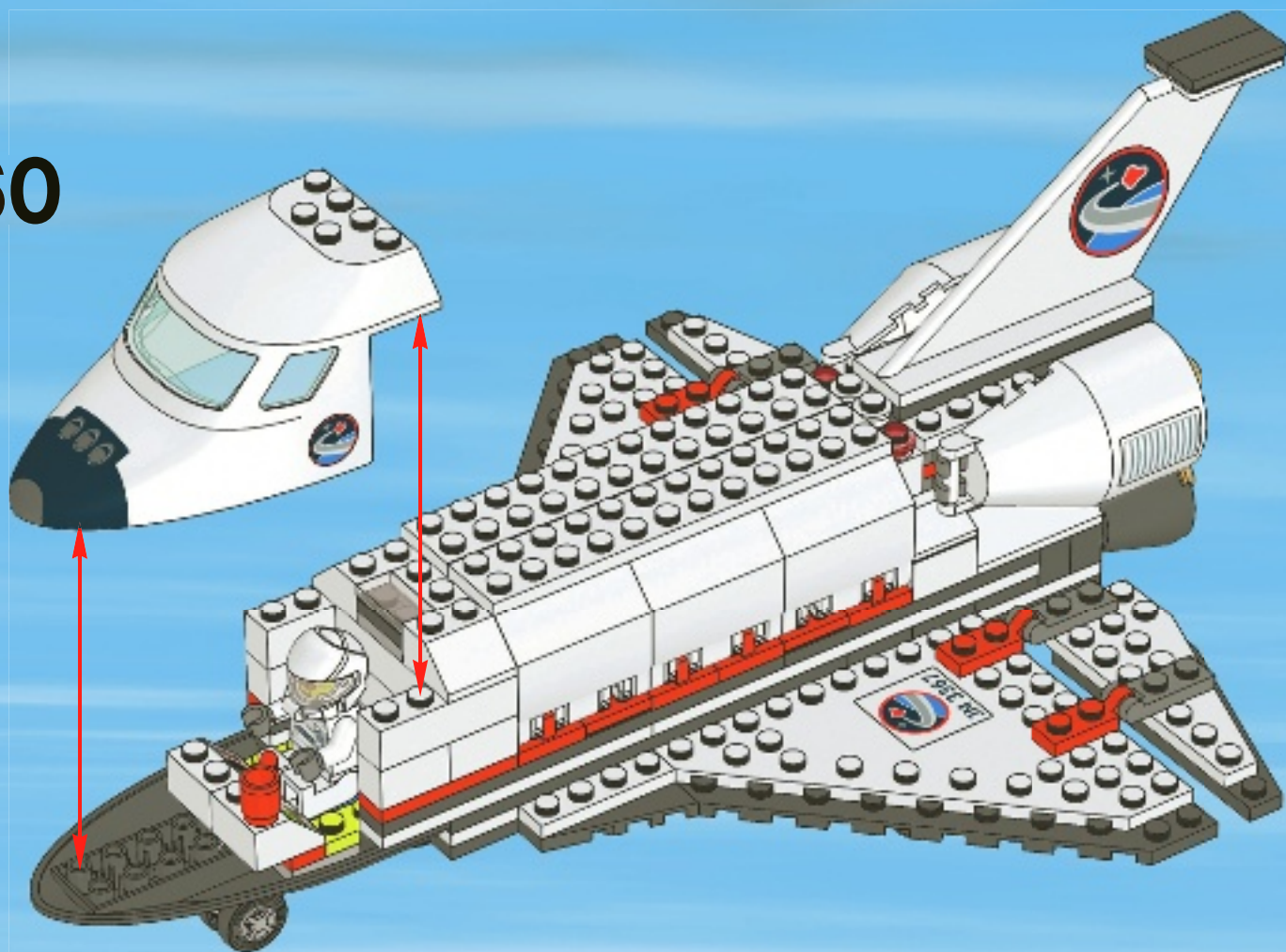



An astronaut's feet can be attached to the end of the Canadian arm to position him or her at a specific location for work in space.

Die Füße eines Astronauten können an einem Roboterarm befestigt werden, wenn er im Weltraum an einer bestimmten Stelle arbeiten muss.

Les pieds d'un astronaute peuvent être attachés à l'extrémité du Bras Canadien afin de positionner à l'endroit précis où il doit travailler dans l'espace.

Los astronautas pueden sujetar sus pies al extremo de un brazo mecánico denominado Canadarm para alcanzar una posición específica y llevar a cabo su labor en el espacio.

Os pés de um astronauta podem ser presos à extremidade do braço Canadiano para a posicionar numa localização específica de trabalho no espaço.

Az űrhajós lábát rögzíteni lehet a robotkar végéhez, így talál magának biztos pontot a munkavégzéshez az űrben.

NASA Astronaut



LEGO**CITY**

“Happy Birthday” was the first song to be performed in space.

“Happy Birthday” war das erste Lied, das im Weltall gespielt wurde.

« Happy Birthday » a été la première chanson chantée dans l'espace.

La primera canción que se cantó en el espacio fue “Cumpleaños Feliz”.

“Feliz Aniversário” foi a primeira música a ser tocada no espaço.

A “Happy Birthday” volt az első dal, amit az űrben énekeltek.

438 days was the longest duration for single human space mission.

Die längste Weltraummission einer einzelnen Person dauerte 438 Tage.

La mission spatiale humaine la plus longue en un seul vol a été de 438 jours.

La misión espacial más larga en la que han intervenido seres humanos duró 438 días.

438 dias foi a estadia mais longa de uma missão espacial de um só ser humano.

Az egy küldetés során az űrben megszakítás nélkül eltöltött leghosszabb idő 438 nap.

NASA Space Shuttle





The Space Shuttle's total thrust at liftoff is 7.8 million pound-force.

Die Schubkraft eines Space Shuttles beim Start entspricht etwa 34.700 Kilonewton.

La poussée totale de la navette spatiale lors du décollage est de 34,7 millions de newtons.

Al despegar, una lanzadera espacial desarrolla un empuje total de 34,7 millones de newtons.

A Força de impulso do voivém espacial ao descolar é de 34.700 kN.

Az űrsikló teljes tolóereje felszálláskor 34 700 kN (7,8 millió font-erő).

NASA Space Shuttle

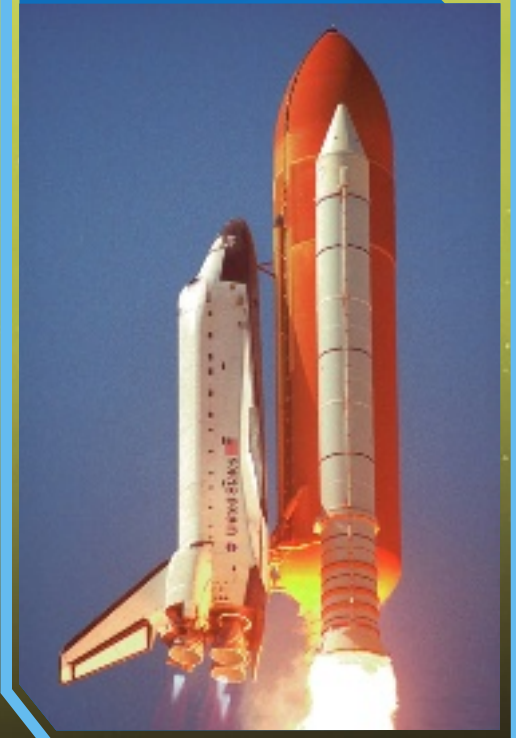

The LEGO CITY logo is located in the top left corner. It consists of the word "LEGO" in its signature yellow font with a black outline, set against a red square background. To the right of this is the word "CITY" in a blue, stylized font with a white outline.The word "CITY" is part of the LEGO CITY logo, positioned to the right of the "LEGO" text.

**IF someone next to you
shouted in the vacuum of space you wouldn't be able
to hear them.**

Wenn jemand im luftleeren Weltall neben dir schreien würde,
könntest du die Person nicht hören.

Si une personne située à côté de vous dans le vide spatial crieait,
vous ne pourriez pas l'entendre.

Si alguien gritara junto a ti en el vacío del espacio, no odrías oírle.

Se no espaço alguém, junto a ti, gritasse no vácuo do espaço não o
conseguirias ouvir.

Ha valaki elkiáltaná magát melletted az üres világűrben, akkor
nem hallhatnád meg.



A Space Shuttle is used to launch satellites, space telescopes and to fix other spacecraft.

Mit einem Space Shuttle werden Satelliten und Weltraumteleskope ins Weltall gebracht. Es wird auch verwendet, wenn andere Raumfahrzeuge repariert werden müssen.

Une navette spatiale sert à lancer des satellites, des télescopes spatiaux et à réparer les autres vaisseaux spatiaux.

Una lanzadera espacial sirve para lanzar satélites y telescopios espaciales, así como para solucionar los problemas de otras naves.

Um vaivém espacial é usado para lançar satélites, telescópios espaciais e para reparar outras naves espaciais.

Az űrsiklót muholdak, űrtávcsövek Fellövésénél és más űrjárművek javításánál használják.



A School bus can fit in the payload bay of the Space Shuttle.

In den Laderaum eines Space Shuttles würde ein Schulbus passen.

Un bus scolaire peut entrer dans la soute de la navette spatiale.

La bodega de carga de una lanzadera espacial podría albergar un autobús escolar.

Um autocarro escolar cabe dentro do porão do vaivém espacial.

Egy iskolabusz is beférne az űrsikló rakterébe.

NASA Space Shuttle



LEGO**CITY**

In collaboration with NASA, In Zusammenarbeit mit der NASA,
En collaboration avec la NASA, En colaboración con la NASA,
Em colaboração com a NASA, A NASA közreműködésével.

NASA Astronaut



Astronauts are up to 2 inches taller while they are in space. This is due to lack of spinal compression by gravity.

Astronauten sind im Weltraum bis zu 5 cm größer als auf der Erde. Der Größenunterschied kommt von der Fehlenden Belastung der Bandscheiben ohne Schwerkraft.

Les astronautes sont jusqu'à 5 cm plus grands lorsqu'ils sont dans l'espace. Ceci est dû à l'absence de compression de la colonne vertébrale par la gravité.

La altura de los astronautas aumenta hasta 5 centímetros durante su estancia en el espacio. Ello se debe a que la columna vertebral no sufre la compresión que la gravedad causa sobre ella.

Os astronautas ficam até 5 cm mais altas quando estão no espaço. Isso deve-se à ausência de compressão vertebral produzida pela gravidade.

Az űrhajósak akár 5 cm-rel is magasabbak lehetnek, amikor az űrben vannak. Ez azért van, mert a gerincüket nem nyomja a nehézségi erő.





CITY



3365



3366



3367



3368

LEGO CITY



7279



7285



7286



7287



7288



7498



www.LEGOclub.com



LEGO® Club Email

LEGO club™

FREE! GRATIS! GRATUIT!



LEGO® Club Magazine

SIGN UP ONLINE!

www.LEGOclub.com



00800 5346 5555*



1-866-534-6258 • 1-877-518-5346

US & Canada only

Canada seulement

* Freephone. Mobile charges may apply.
* Numéro sans frais. Des frais peuvent s'appliquer avec les téléphones cellulaires.
* Gebührenfrei. Kosten für Anrufe aus Mobilfunknetzen können abweichen.
* Gratis telefonnummer vanaf vaste lijn.
* Det er et gratis nummer, når du ringer fra fasttelefon.
* Det är gratis, när du ringer från en fast telefon.
* Numéro sans frais. Des frais peuvent s'appliquer avec les téléphones portables.



Customer Service
Kundenservice
Service Consommateurs
Servicio Al Consumidor

www.lego.com/service or dial



: 00800 5346 5555
 : 1-800-422-5346



WIN!

Go to www.LEGOsurvey.com/product to fill out a survey for a chance to win a cool LEGO® Product. No purchase necessary. Open to all residents where not prohibited.

 www.LEGO.com



www.LEGOsurvey.com/product

GEWINNE! WIN!

Nimm an der Umfrage auf www.LEGOsurvey.com/product teil und hab die Chance ein cooles LEGO® Produkt zu gewinnen!

Die Teilnahme am Gewinnspiel führt zu keinerlei Kaufverpflichtungen. Teilnahme in allen nicht ausgeschlossenen Ländern möglich.

Ga naar www.LEGOsurvey.com/product, vul een enquêteformulier in en maak kans op een cool LEGO® product.

Geen aankoopverplichting. Iedereen mag deelnemen, uitzonderend ingezetenden van landen waar een enquêteverbod geldt.

GAGNE! 当てよう!

Visite www.LEGOsurvey.com/product pour répondre à un questionnaire et avoir une chance de gagner un produit LEGO® très cool!

Aucune obligation d'achat. Ouvert à tous les résidents des pays autorisés.

www.LEGOsurvey.com/product にアクセスして、アンケートにご記入ください。当選者にはレゴ®製品を差し上げます。

お買い上げの必要はありません。

禁止されていない限り、すべての皆様にご利用いただけます。