



**BRICK
HEADZ**

40628





Get excited about our new packaging!

We're switching from plastic to paper-based packaging. That's why you might find a mix of paper and plastic in our boxes!

Nos nouveaux emballages vous emballeront !

Nous passons des emballages en plastique aux emballages à base de papier. C'est pourquoi vous pourriez trouver un mélange de papier et de plastique dans nos boîtes !

¡Te presentamos nuestros nuevos empaques!

Estamos sustituyendo las bolsas de plástico por bolsas con base de papel. ¡Por eso, puedes encontrar una mezcla de papel y de plástico en nuestras cajas!

[LEGO.com/sustainable-packaging](https://www.lego.com/sustainable-packaging)

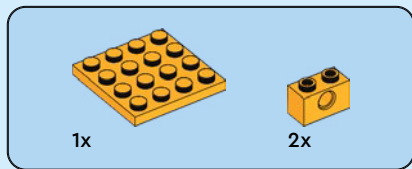

1

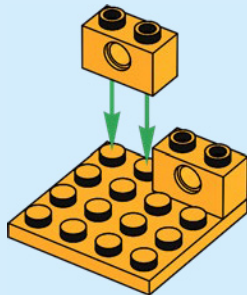



1x



1x

2

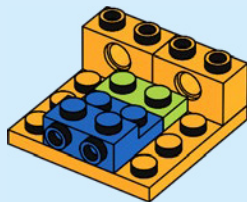

4x

3

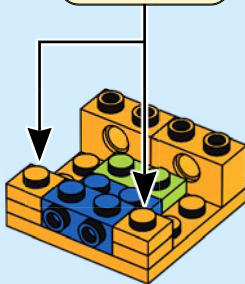
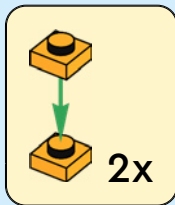



2x

4

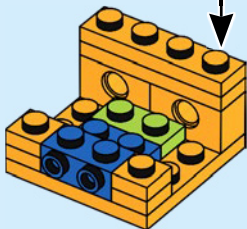
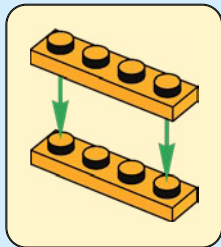

1x



1x

5

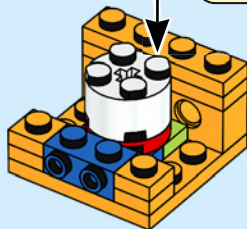
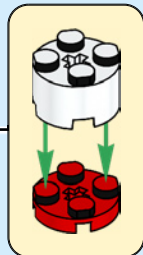

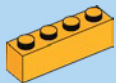

1x



2x

6

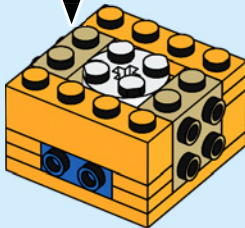
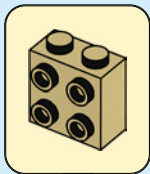

6



1x

7

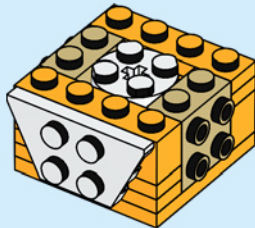

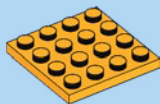

1x

8

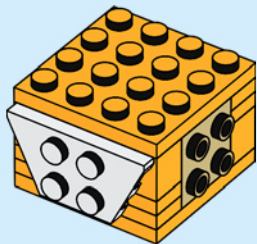

6x

9

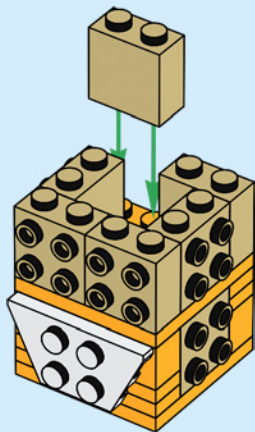



2x

10

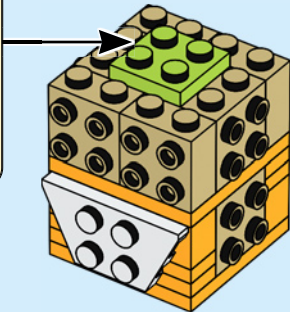
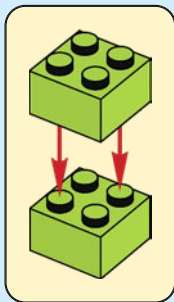



2x

11

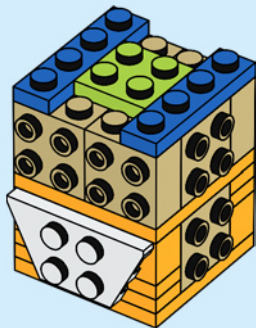

4x



4x

12

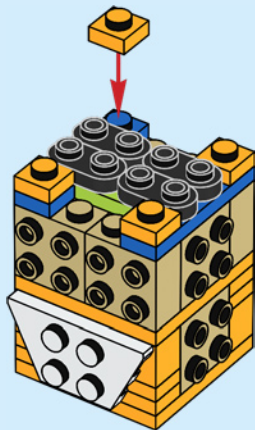



2x



1x



13

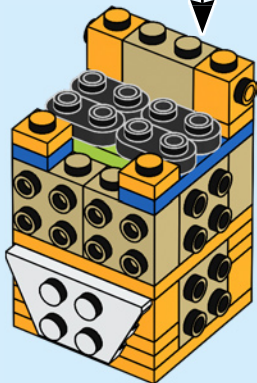



1x

14

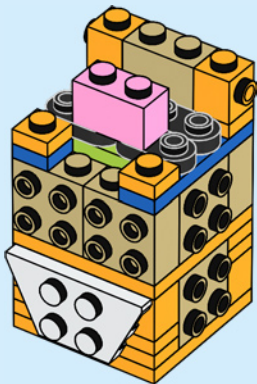

2x



1x

15

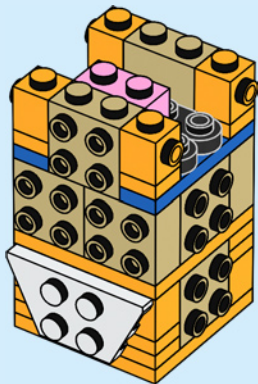

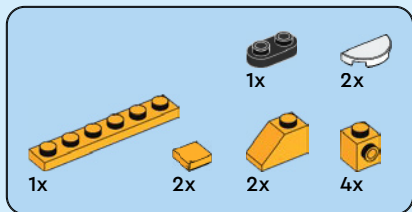

16

1

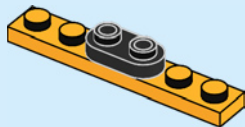

2

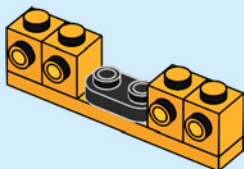

3

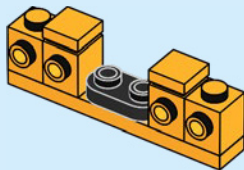

4

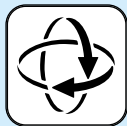
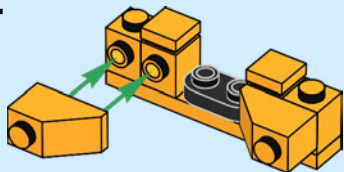

5

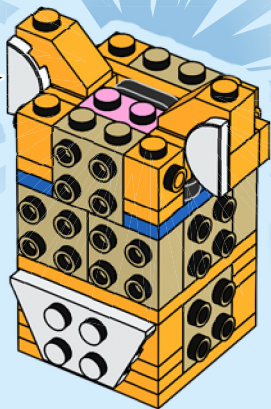
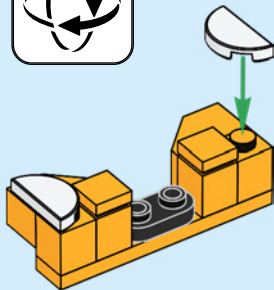



1x

17

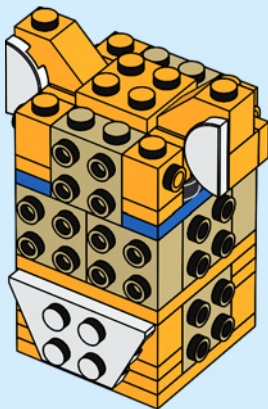

2x

18

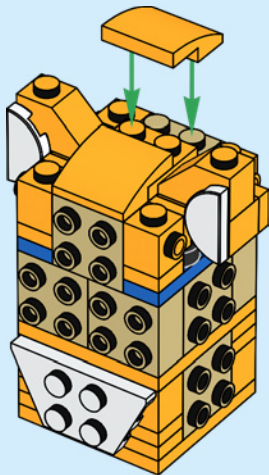

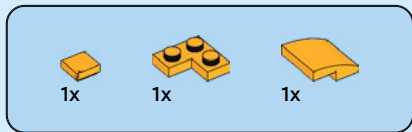

19

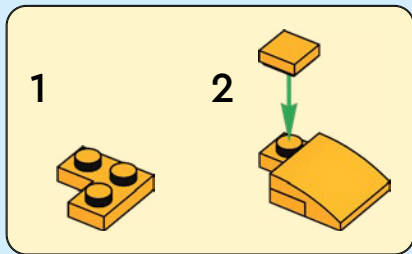
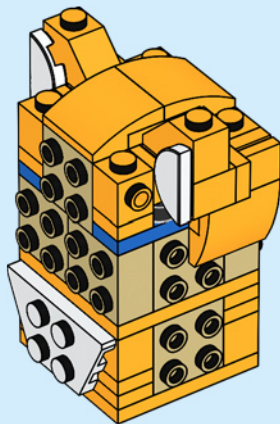



1x



1x



1x

20

1



2

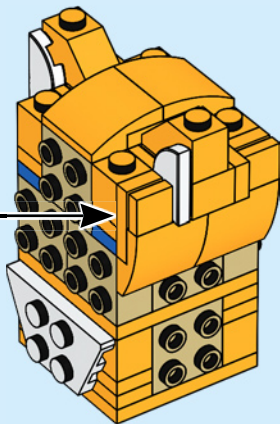
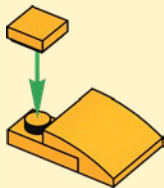



1x



1x

21

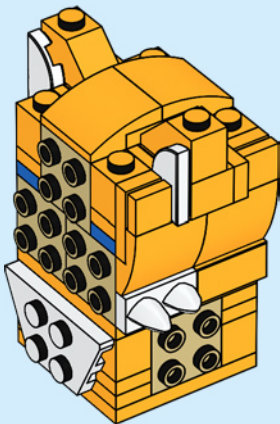

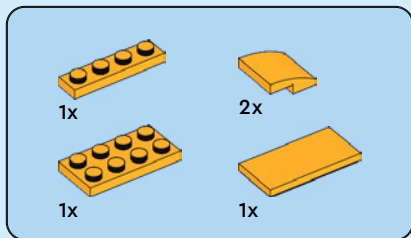

22

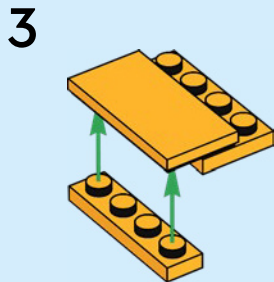
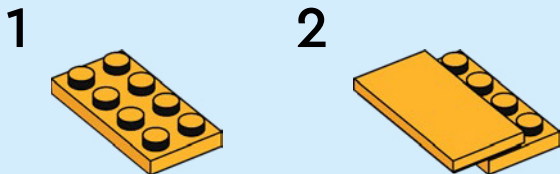

4

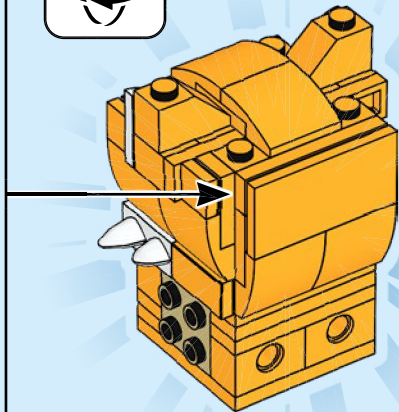
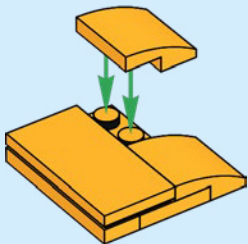

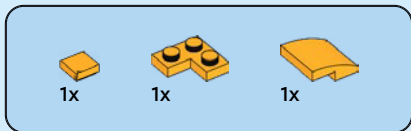

23

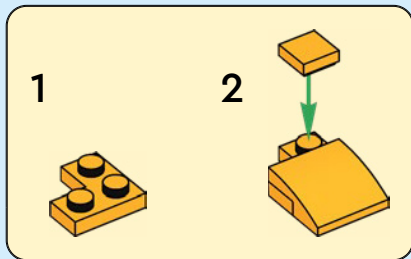
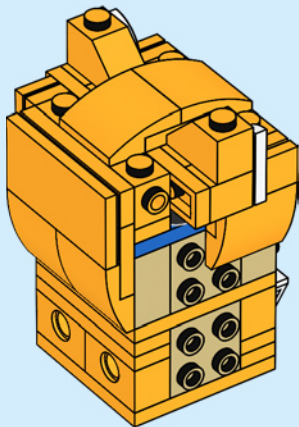



24

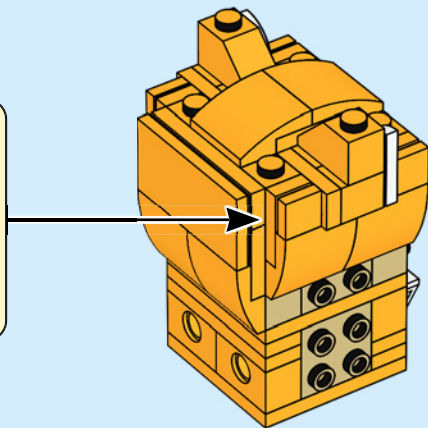
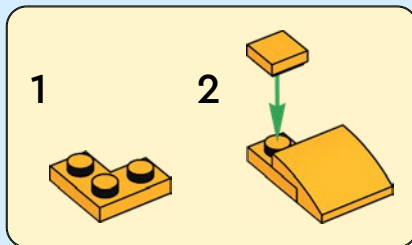



1x



1x

25

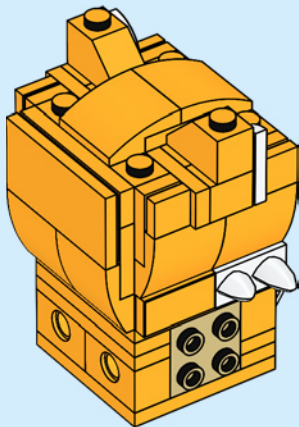



2x

26

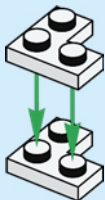

1x



1x

27

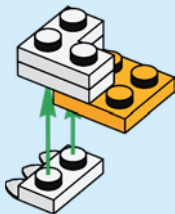



2x



1x

28

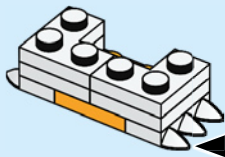
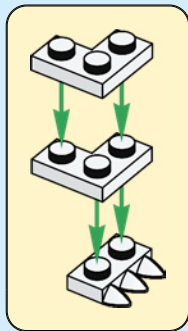

1x



2x

29

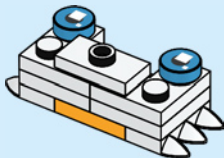



1x



2x

30

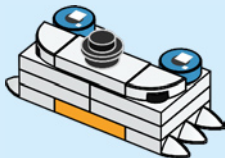

31

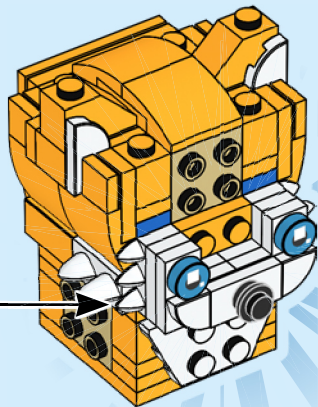
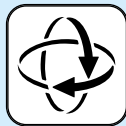

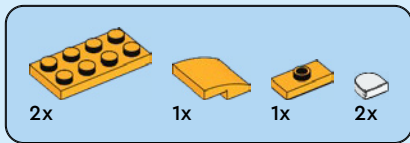

32

1

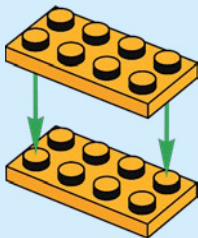

2

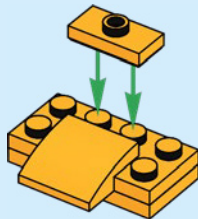

3

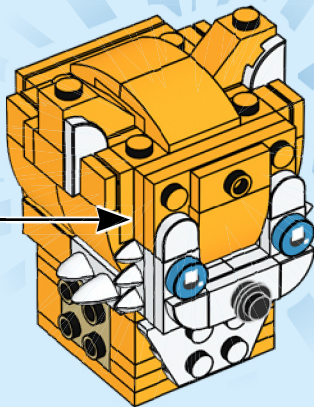
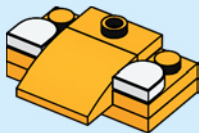

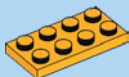

1x

33

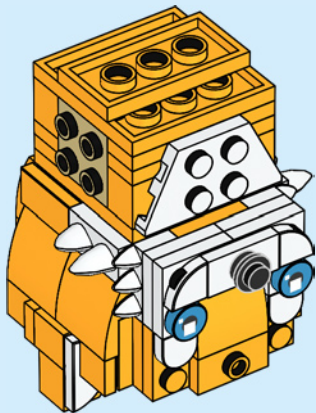
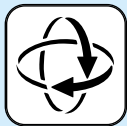



2x

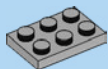

2x



2x



2x



4x

34

1

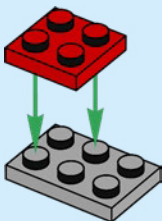

2

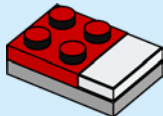

3



2x

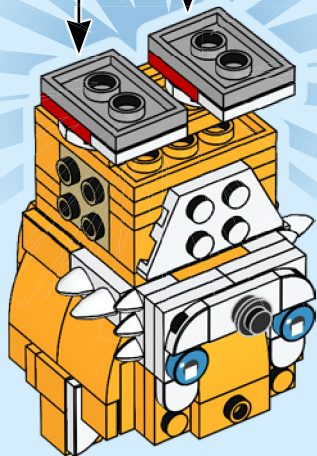



35

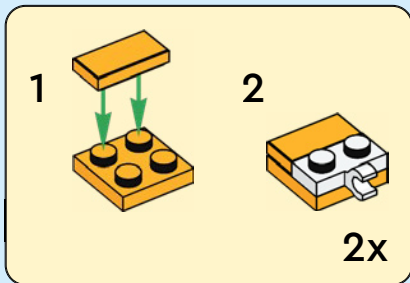
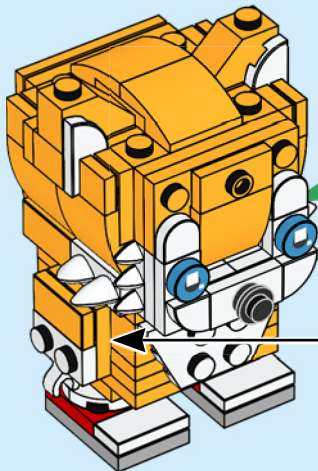



36

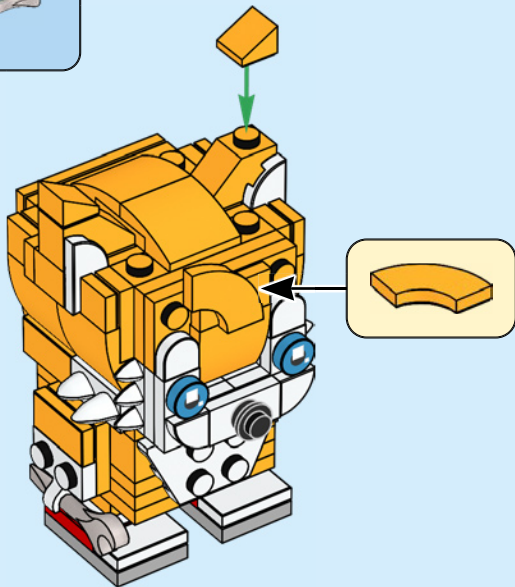



2x



2x



2x

3



2x



2x



3

1:1

37

1

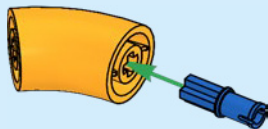

2

3

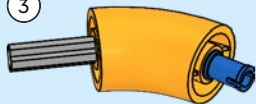

3

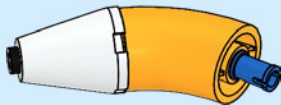

2x

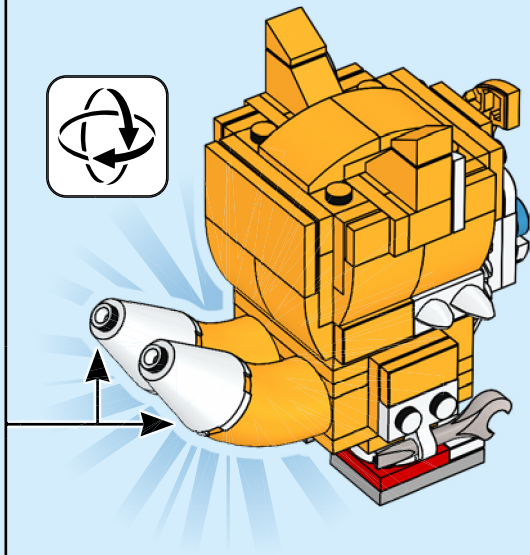
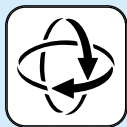

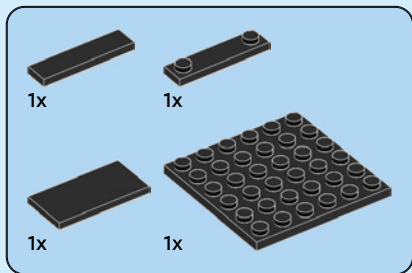

38

1

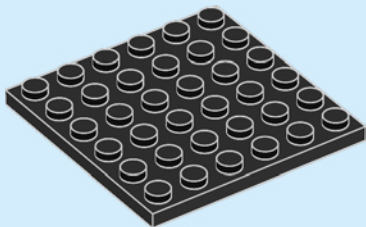

2

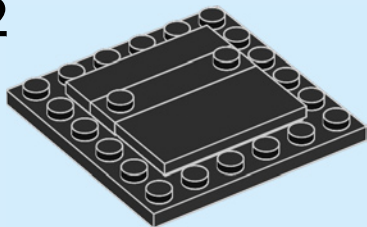

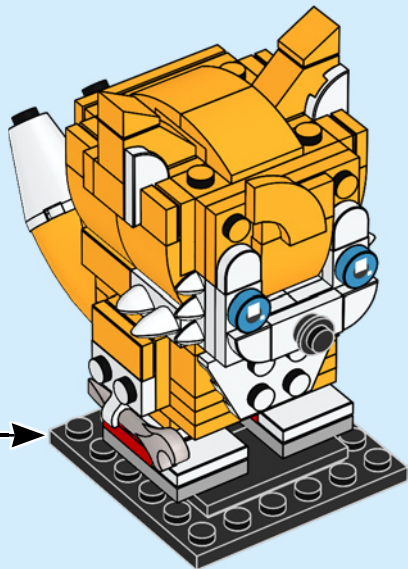
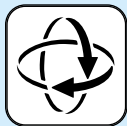

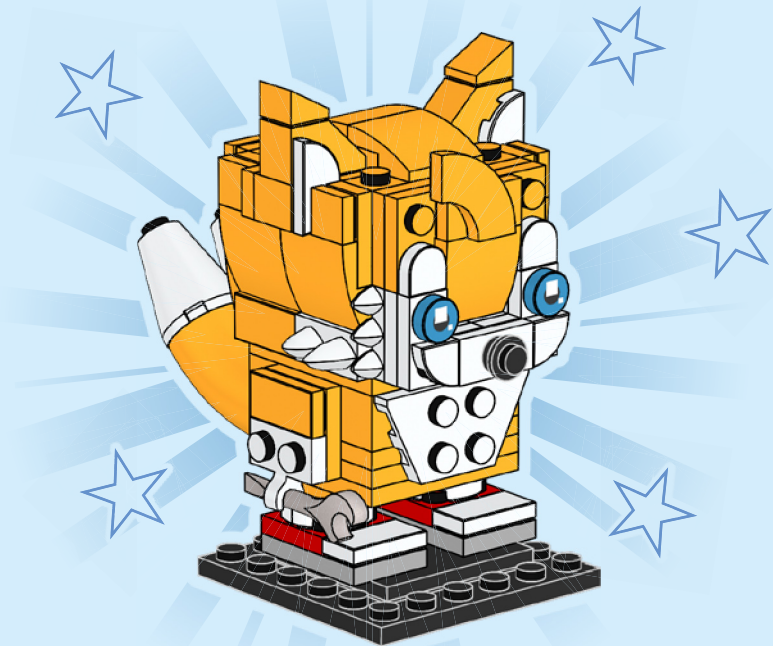



**BRICK
'HEADZ**

40627



SONICTM
THE HEDGEHOG

SONIC THE HEDGEHOGTM 40627

213

- | | | | | | | | | |
|---------------|---|---------------|---------------|---------------|---------------|----------------|---------------|---------------|
| 2x
4211815 | 3 | 6x
6065504 | 3x
6020073 | 8x
6092035 | 1x
6044601 | 1x
614301 | 1x
403221 | 2x
4206482 |
| 2x
4211396 | | 2x
6023173 | 1x
6003004 | 9x
6099730 | 2x
6172366 | 10x
6214334 | 2x
302221 | 1x
6469450 |
| 1x
614126 | | 8x
6073040 | 4x
6097511 | 4x
6003033 | 2x
6313115 | 1x
4164037 | 1x
4517993 | 2x
371023 |
| 5x
6210270 | | 2x
6023157 | 4x
6099714 | 4x
6099714 | 1x
6051511 | 2x
4220632 | 1x
6167576 | |
| 1x
6254045 | | 2x
6186081 | 1x
4621543 | 1x
6334203 | 2x
306901 | 2x
6455633 | | |
| 1x
243126 | | 4x
4622062 | 1x
6020074 | 2x
6250591 | 2x
6046384 | | | |
| 1x
4560182 | | 1x
6122504 | 2x
6093272 | 2x
6400114 | 2x
6046381 | | | |
| 1x
395826 | | | 2x
6439715 | 4x
6462354 | 4x
242001 | | | |
| | | | | 1x
4249506 | | | | |

 [LEGO.com/service](https://www.LEGO.com/service)



YOU COULD

WIN



Scan this QR code or go to
LEGO.COM/PRODUCTFEEDBACK and give us
your short feedback about this LEGO® set
for a chance to win a cool LEGO prize.

Terms and Conditions apply*

EN: YOU COULD WIN. Terms and Conditions apply* **DE: Du könntest GEWINNEN.** Es gelten die Teilnahmebedingungen* **FR: Tu pourrais GAGNER.** Des conditions s'appliquent* **IT: Potresti VINCERE tu.** Termini e condizioni sono applicabili* **ES: Puedes GANAR.** Aplican términos y condiciones* **PT: Poderá GANHAR.** Aplicam-se termos e condições* **ZH: 轻松获奖. 条款和条件适用*** **PL: Szansa na WYGRANĄ.** Obowiązują warunki korzystania* **CS: Máte šanci VYHRÁT.** Platí všeobecné smluvní podmínky* **SK: Máte šancu VYHRÁT.** Platia všeobecné zmluvné podmienky* **HU: TE IS NYERHETSZ.** Felhasználási feltételek érvényesek* **RO: Ai putea CÂȘTIGA.** Se aplică termenii și condiții* **BG: Можете да СПЕЧЕЛИТЕ.** Има определени правила и условия* **LV: Tu vari LAIMĒT.** Ir spēkā noteikumi un nosacījumi.* **ET: Sul on võimalus VÕITA.** Kehtivad tingimused* **LT: Jūs galite LAIMĖTI.** Taikomos sąlygos*

*[LEGO.com/productfeedback-terms](https://www.lego.com/productfeedback-terms)

LEGO and the LEGO logo are trademarks of the/sont des marques de commerce du/son marcas registradas de LEGO Group. ©2023 The LEGO Group.

©SEGA. All rights reserved. SEGA is registered in the U.S. Patent and Trademark Office. SEGA and SONIC THE HEDGEHOG are either registered trademarks or trademarks of SEGA CORPORATION.

6480149