



LEGENDS OF

# CHIMA

TM

70147



 [LEGO.com](http://LEGO.com)

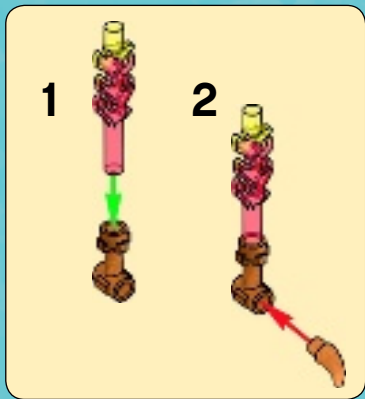

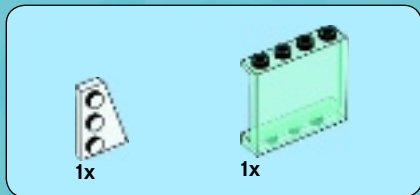

**1**

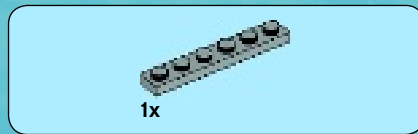
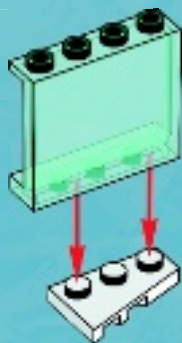

**2**

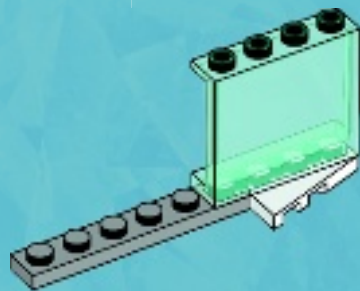



1x



2x



2x



1x



1x

# 3

## 1



## 2



## 3

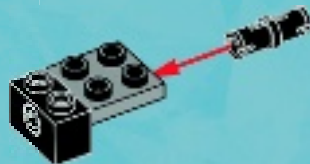

## 4



5

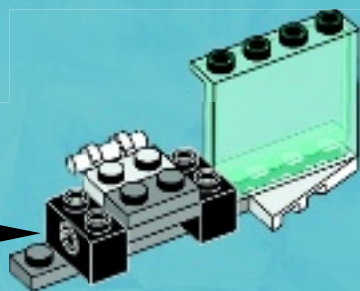



2x

4

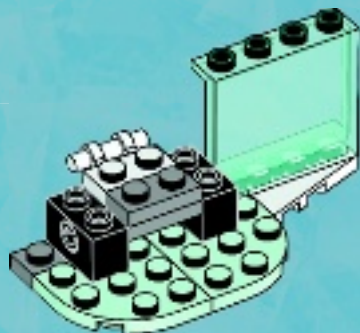

1x



1x



1x

5





1x



1x

6

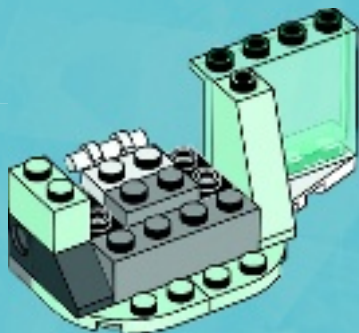

1x



1x

7

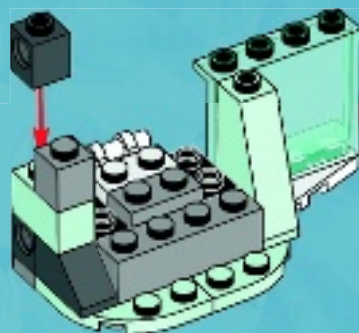

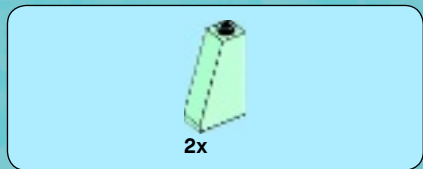

8



8

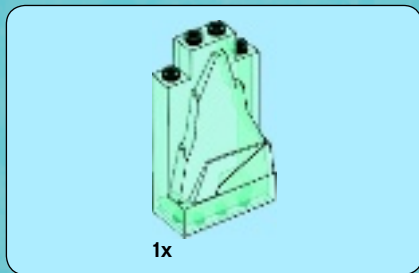

9

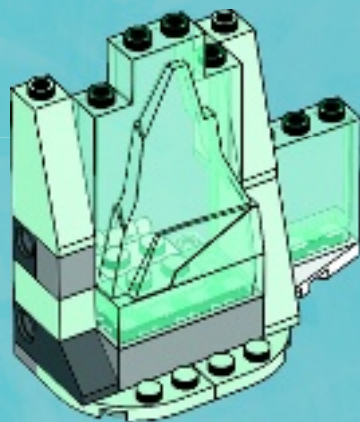





2x

10

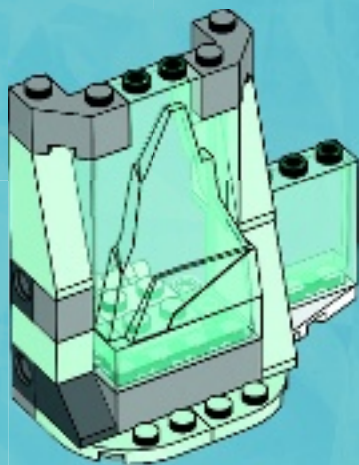



2x

11

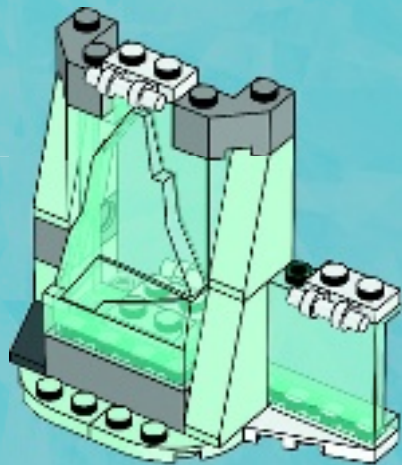

3x

12

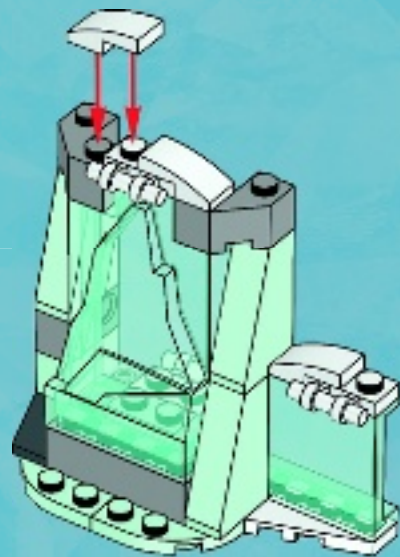



2x

13



2x

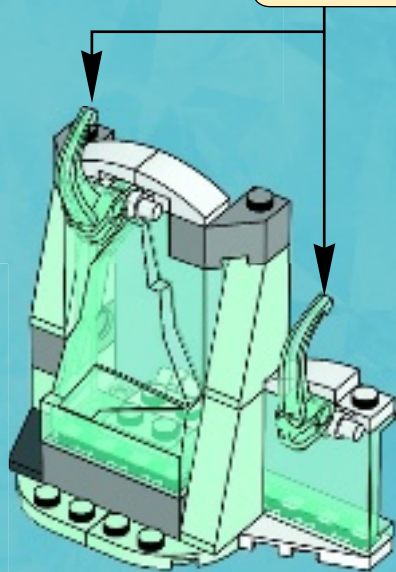



2x

# 14

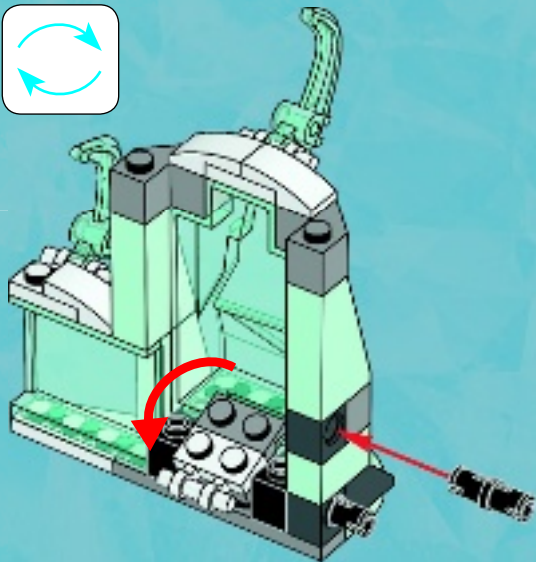
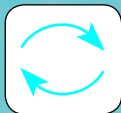

12



1x

# 15

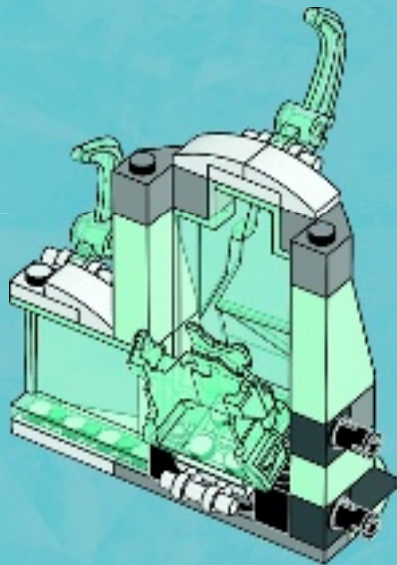

1

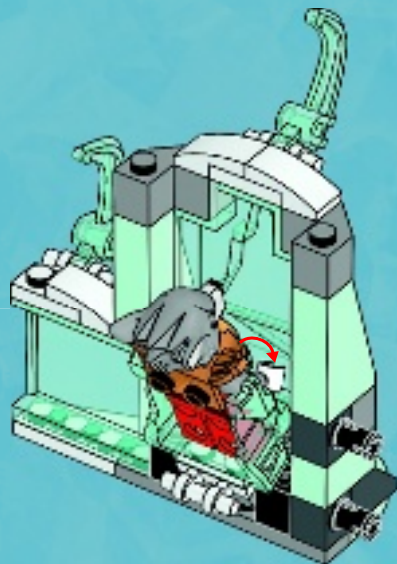

2

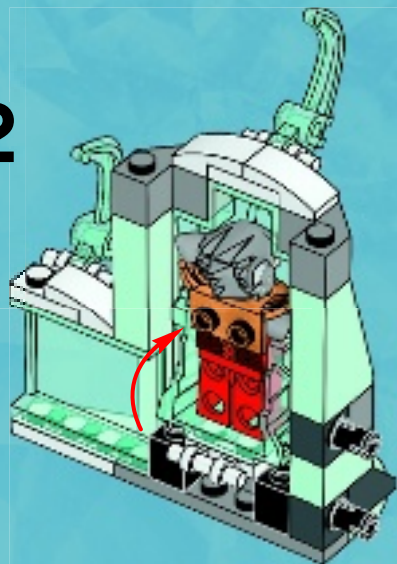

4

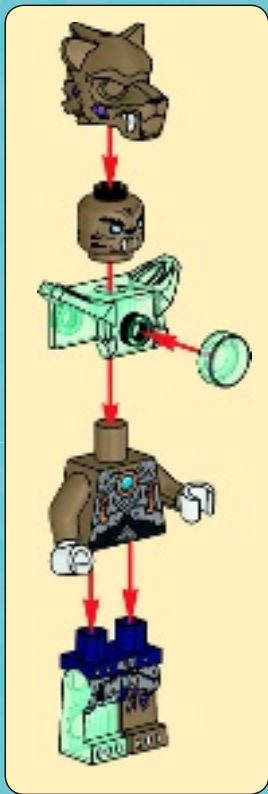

1



2



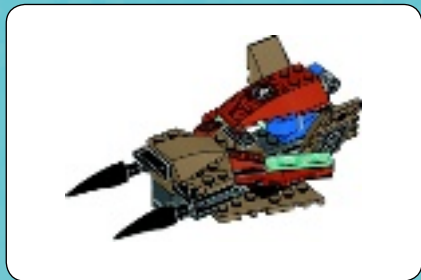

1



2





1x

3



1x



2x

4

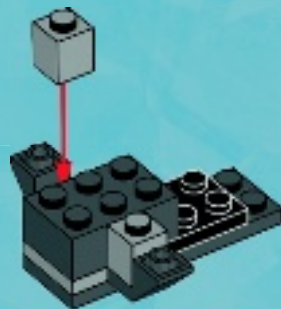



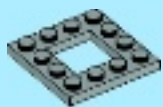

1x

5



1x



1x

6

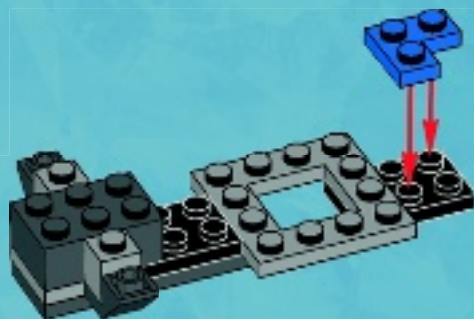



1x



1x

# 7

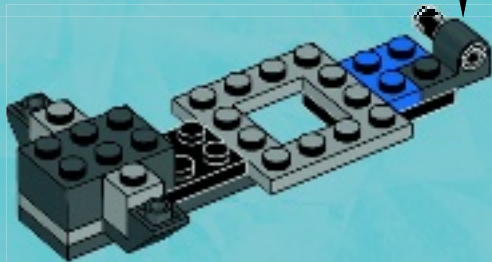

2x

# 8



2x

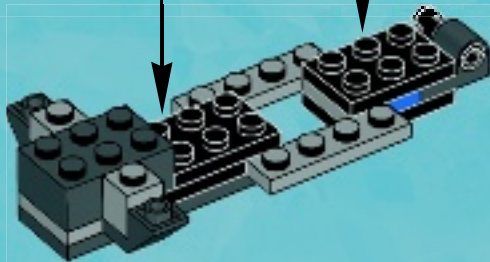

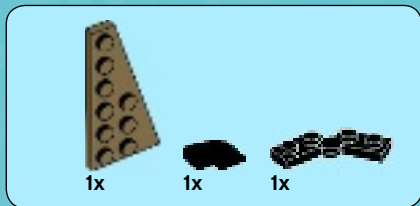

9

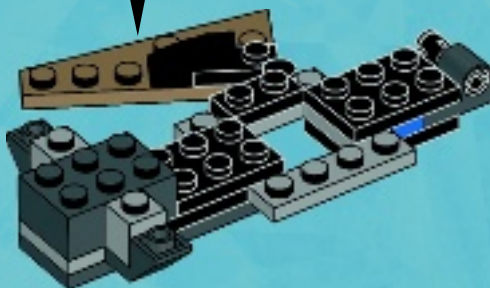

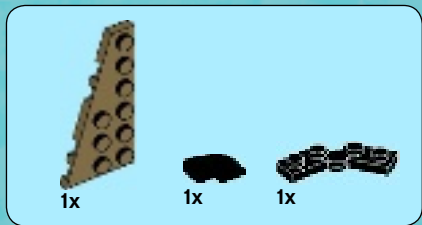

10

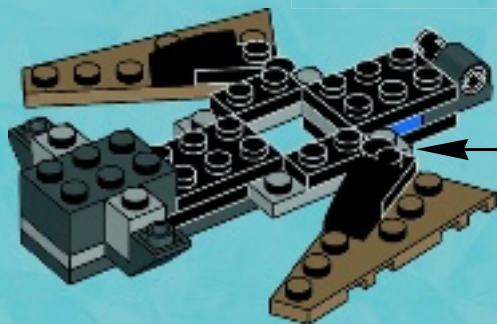
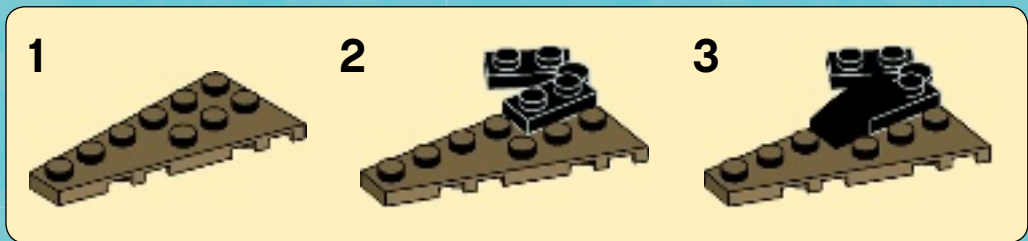



2x

# 11

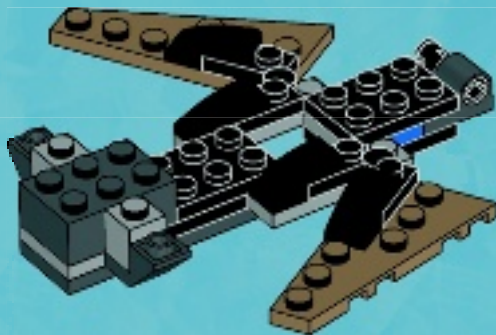

1x



2x

# 12

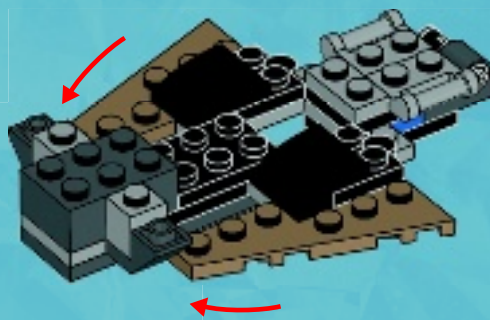



2x

# 13



2x

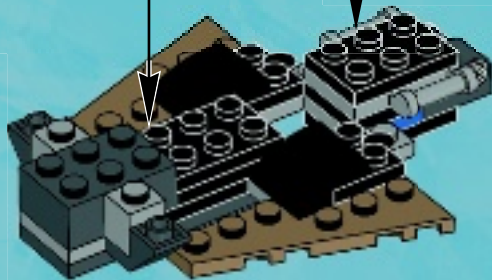

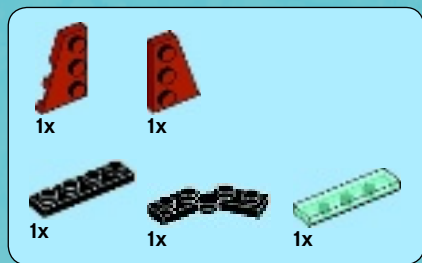

# 14

1



2



3



4



5

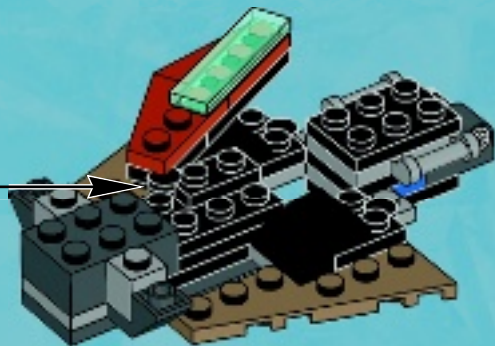



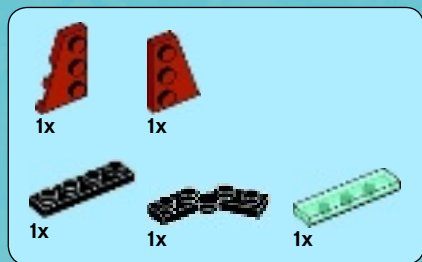

# 15

1



2



3



4



5

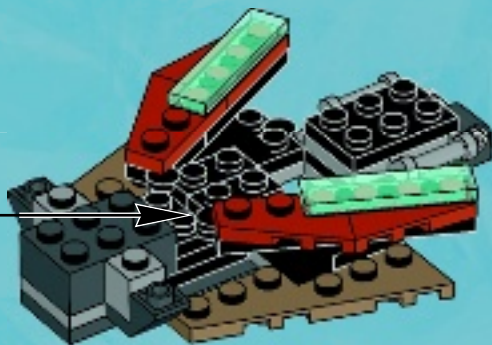



2x

# 16

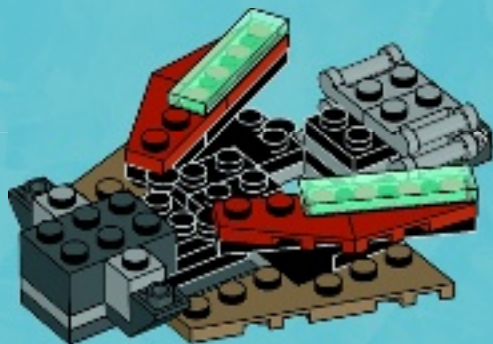

1x

# 17

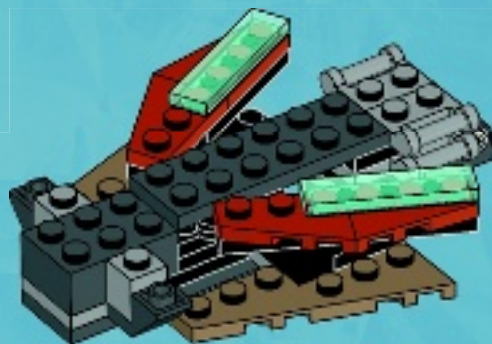

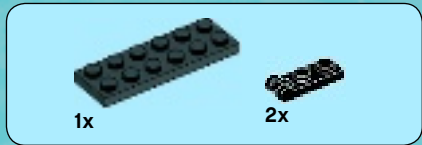

# 18

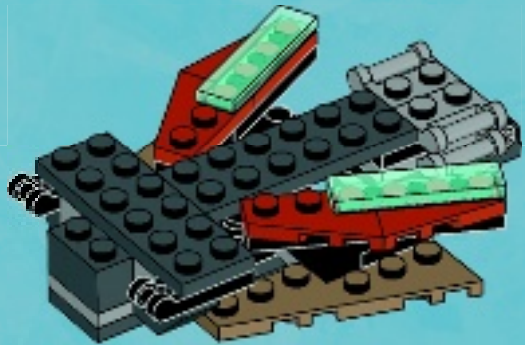
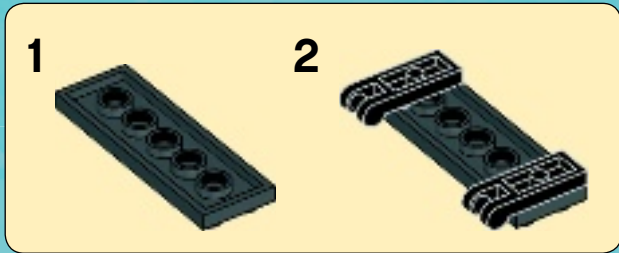



2x



2x

# 19



2x

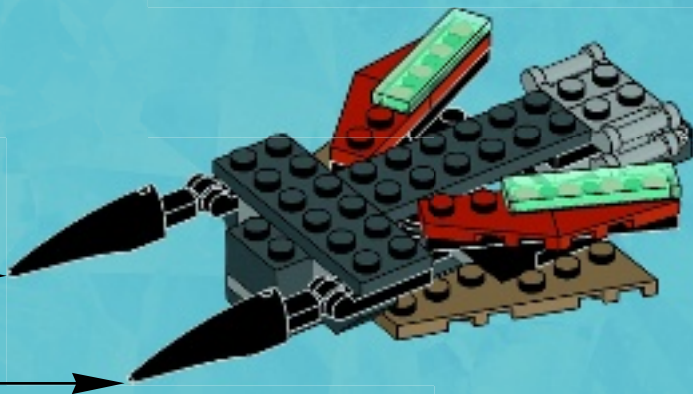



1x

20

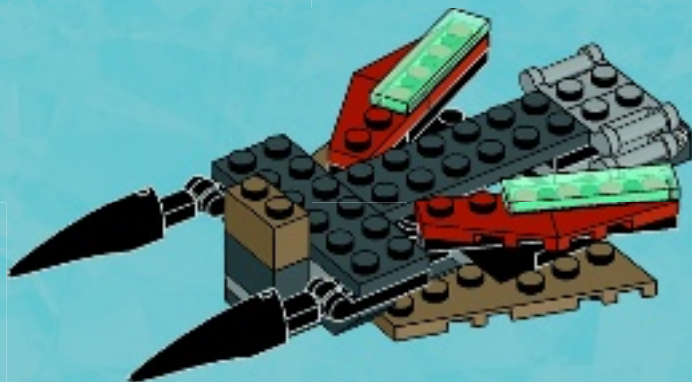



2x



1x

# 21

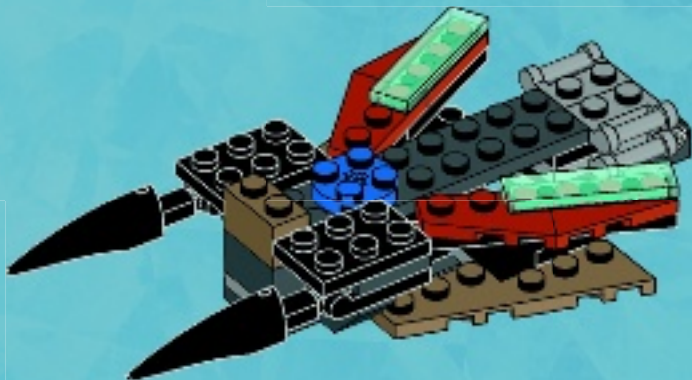



2x

# 22

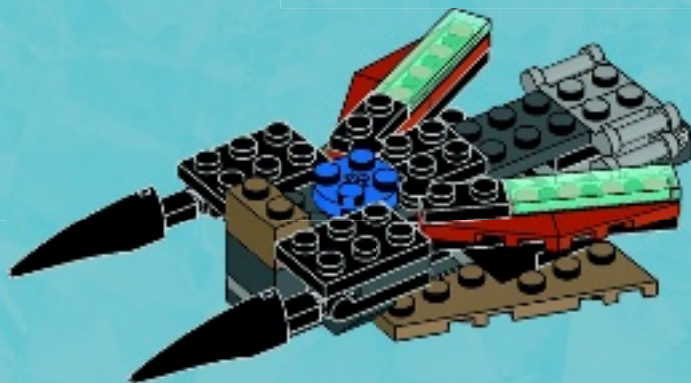





2x

23





1x



2x

# 24

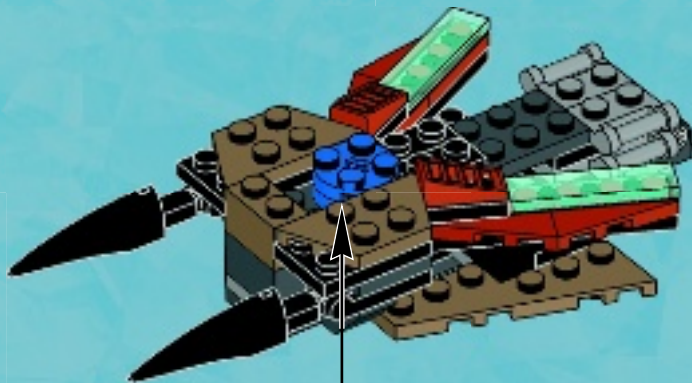

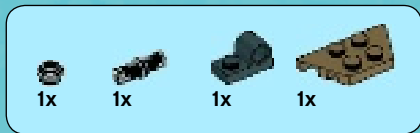

25

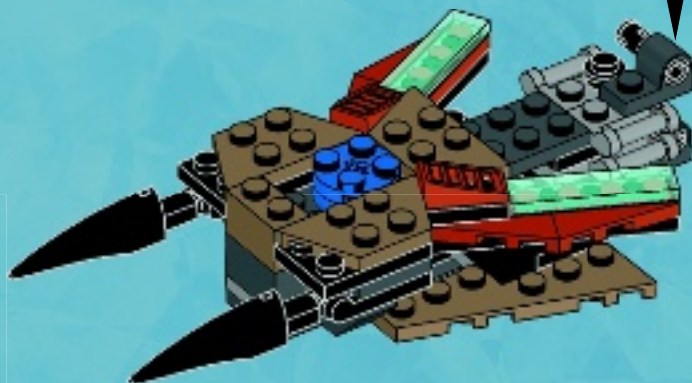



2x

# 26

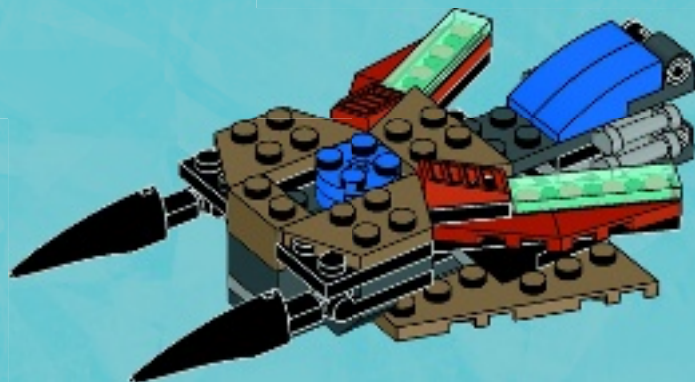



1x

# 27

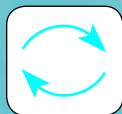
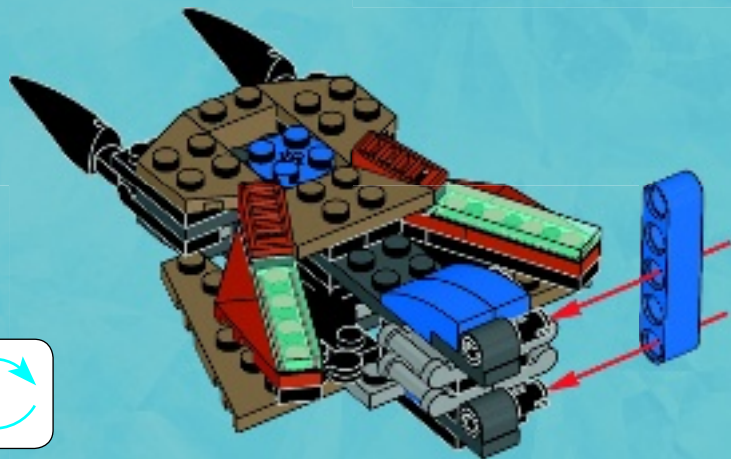

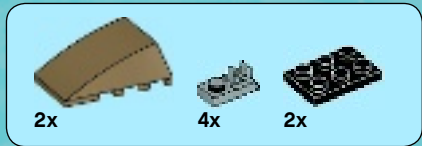

28

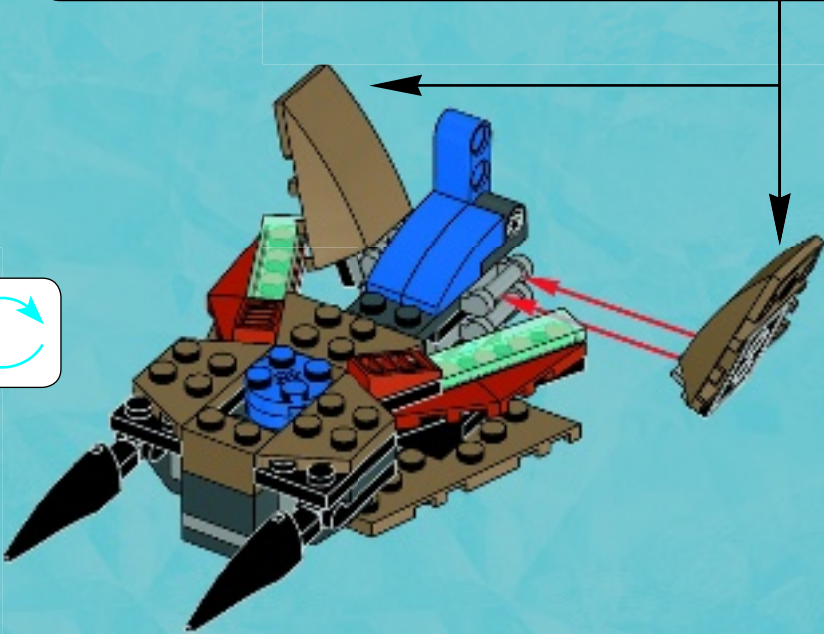
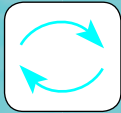
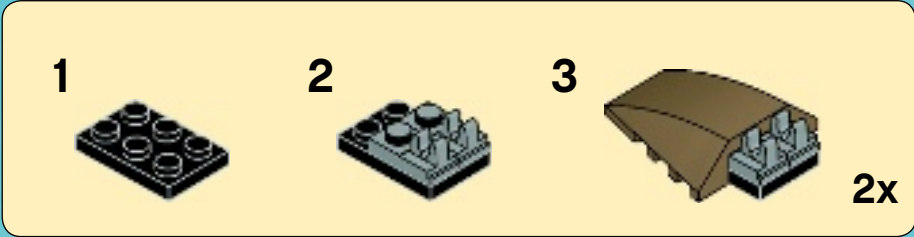



1x



1x

# 29

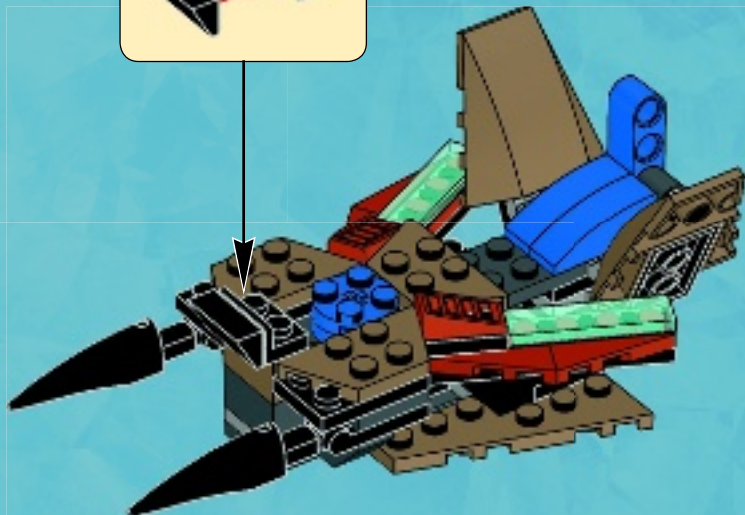
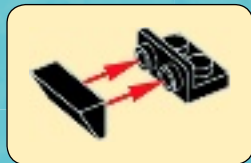



1x

30

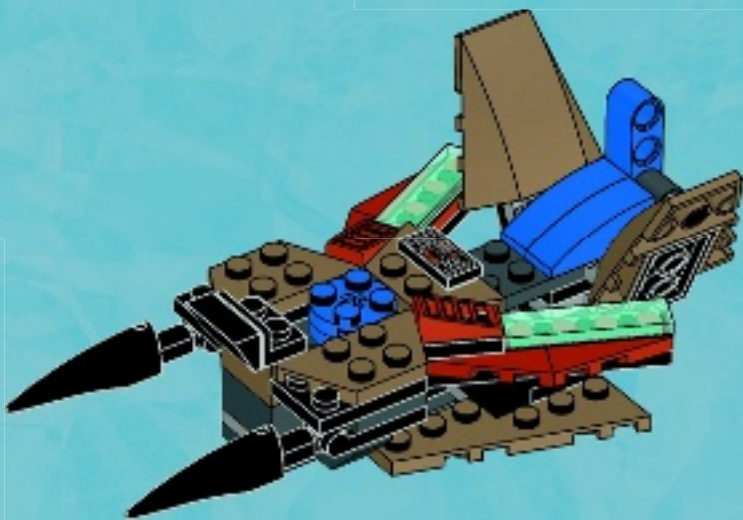

40



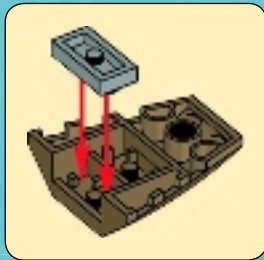
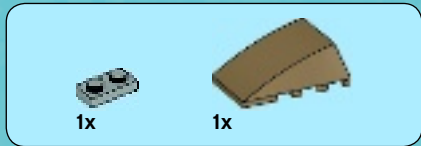

31





1x

1



1x

2

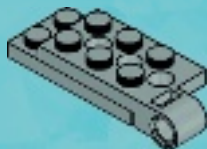



1x

3

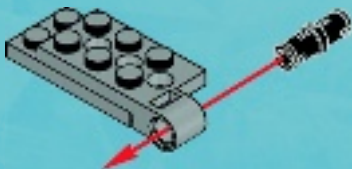

1x

4

1



2





1x

5

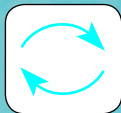

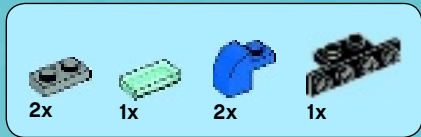

# 6

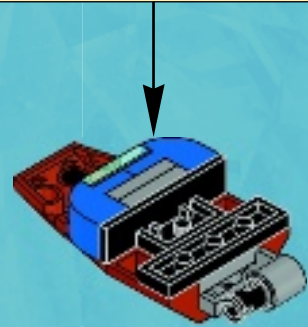
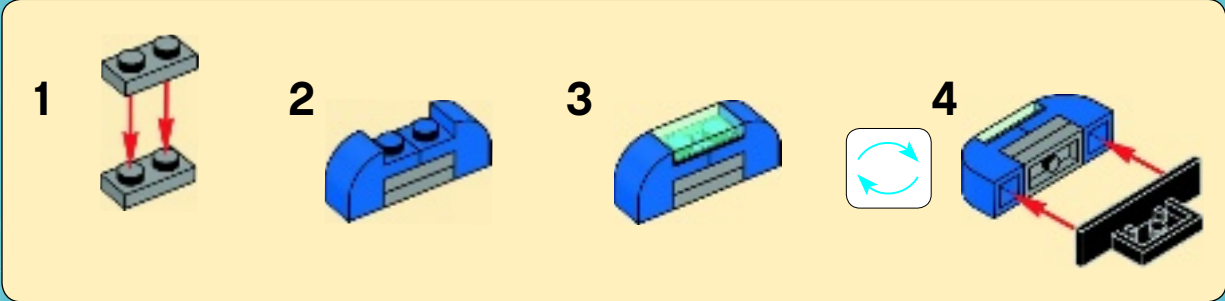



1x

7

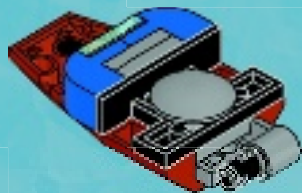

32

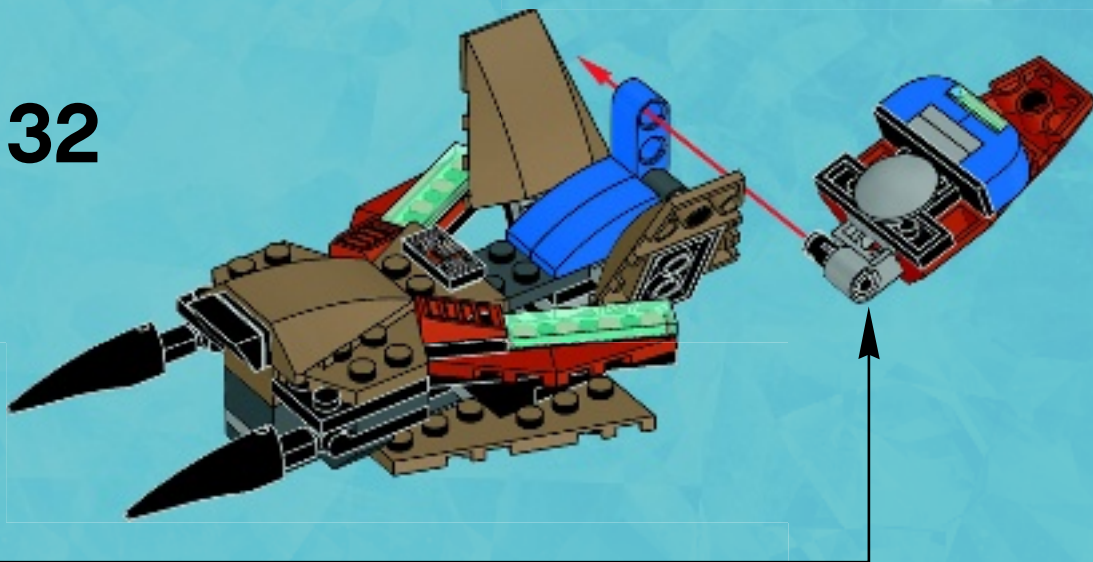

33

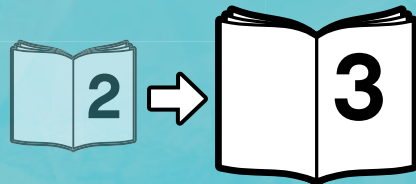
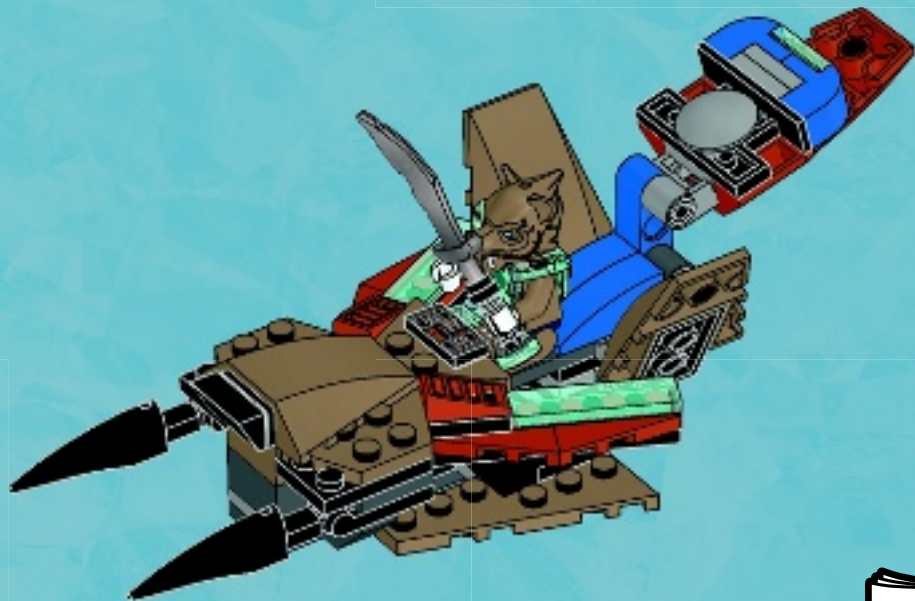



**ENTER FIRE CHI POWER MODE!  
ENTRE EN MODE DE PUISSANCE  
CHI DE FEU!  
¡ACTIVA EL MODO  
DE CHI DEL FUEGO!**



70142

70144

70146

**DETACHABLE VEHICLE INCLUDED!  
VEHICULE DÉTACHABLE INCLUS!  
¡INCLUYE UN VEHICULO  
DESMONTABLE!**



70141

70143

70145



LEGENDS OF  
**CHIMA**<sup>TM</sup>



**LAVAL**

70144, 70156



**CRAGGER**

70135, 70144,  
70150



**WORRIZ**

70145, 70147,  
70149, 30265



**ERIS**

70142



**FLUMINOX**

70146, 70155



**FLINX**

70146



**GORZAN**

70143, 70147



**RAZAR**

70145



**MOTTROT**

70145



**MAULA**

70145



**VARDY**

70141



**VOOM VOOM**

70146, 70147,  
70151



**SIR FANGAR**

70143, 70147,  
70156



**STRAINOR**

70142, 70145,  
70147



**STEALTHOR**

70135, 70143,  
70146



**MUNGUS**

70144

LEGO, the LEGO logo and LEGENDS OF CHIMA are trademarks of the /sont des marques de commerce de /son marcas registradas de LEGO Group.  
©2014 The LEGO Group.  
6104492

**NEW APP!  
DOWNLOAD  
NOW!**



LEGO  
**CHIMA**  
ONLINE

**NOUVELLE APP!  
TELECHARGER  
MAINTENANT!**



**CHIMAONLINE.COM**

© 2014 The LEGO Group.™ & © WBEI. (s14)  
Only supported in US and Canada. Playable on iPad 2 and up, iPad mini, iPhone 4S and up and iPod touch 5th generation and up. Apple, the Apple logo and iPad are trademarks of Apple Inc., registered in the U.S. and other countries. App Store is a service mark of Apple Inc. All other trademarks and copyrights are the property of their respective owners.

Offert uniquement aux États-Unis et au Canada. Fonctionne sur iPad 2 et supérieur, iPad mini, iPhone 4S et supérieur et iPod touch 5e génération et supérieur. Apple, le logo Apple, et iPad sont des marques de commerce d'Apple Inc., déposées aux États-Unis et dans d'autres pays. App Store est une marque de service d'Apple Inc. Toutes les autres marques de commerce et copyrights appartiennent à leurs propriétaires respectifs.

Sólo válido en EE. UU. y Canada. Compatible con iPad 2 y modelos posteriores, iPad mini, iPhone 4S y modelos posteriores, e iPod touch de 5a generación y modelos posteriores. Apple, el logotipo de Apple e iPad son marcas comerciales de Apple Inc., registradas en EEUU, y otros países. App Store es una marca de servicio de Apple Inc. El resto de marcas comerciales y derechos de autor son propiedad de sus respectivos propietarios.